

IGNITABLE LIQUID STORAGE IN PORTABLE CONTAINERS

Table of Contents

	Page
1.0 SCOPE	5
1.1 Hazard	5
1.2 Changes	5
2.0 LOSS PREVENTION RECOMMENDATIONS	6
2.1 Introduction	6
2.1.1 General	6
2.1.2 Liquid Evaluation	7
2.1.3 Atypical Ignitable Liquids	7
2.2 Construction and Location	10
2.2.1 General	10
2.2.2 Drainage and Containment	13
2.2.3 Premanufactured Buildings and Cabinets	18
2.2.4 Outdoor Storage	19
2.3 Occupancy	20
2.3.1 Housekeeping	20
2.3.2 Ventilation	20
2.3.3 Flue Spaces	20
2.4 Protection	20
2.4.1 General	20
2.4.2 Metal Containers (Including IBCs) Larger than 60 gal (230 L)	23
2.4.3 Metal Containers Larger than 6.5 gal (25 L) Up to and Including 60 gal (230 L)	25
2.4.4 Metal Containers of 6.5 gal (25 L) or Less	30
2.4.5 Protection of Plastic, Composite (Plastic-Metal), or Other Combustible Containers: General .	33
2.4.6 Composite (blow molded bottle in a wire cage on a wood or steel pallet) IBC Storage of Liquids with a Flash Point At or Above 200°F (93°C) or Alcohol in Racks or Palletized Storage of Propylene/Ethylene Glycol	35
2.4.7 Plastic, Glass, or Other Combustible/Brittle Containers Up to and Including 60 gal (230 L) .	36
2.4.8 Distilled Spirits in Wooden Barrels: Palletized Storage Arrays	48
2.4.9 Distilled Spirits in Wooden Barrels: Rack Storage Arrays	50
2.4.10 Yard Storage: Any Container Type	53
2.5 Operation and Maintenance	53
2.6 Training	53
2.7 Human Factor	54
2.8 Ignition Source Control	55
3.0 SUPPORT FOR RECOMMENDATIONS	56
3.1 General	56
3.1.1 Composite Intermediate Bulk Containers (IBC)	56
3.2 Liquid Evaluation	57
3.2.1 Water-Miscible Liquids	57
3.2.2 Emulsions	58
3.2.3 Viscous Liquids/Viscous Mixtures	58
3.2.4 Liquids with Boiling Point Below 100°F (38°C)	59
3.2.5 Liquids with Specific Gravity Above 1	59
3.2.6 Atypical Ignitable Liquids	59
3.3 Construction and Location	61
3.4 Ventilation	61
3.5 Protection	61

3.5.1 General	61
3.5.2 Automatic Sprinklers	62
3.5.3 Special Protection Systems	62
3.5.4 Metal Containers	62
3.5.5 Protection of Plastic, Composite (Plastic-Metal), or Other Combustible Containers: General ..	62
3.6 Operation and Maintenance	62
3.7 Training	62
3.8 Ignition Source Control	63
4.0 REFERENCES	63
4.1 FM Global	63
4.2 NFPA	63
4.3 Other	64
APPENDIX A GLOSSARY OF TERMS	64
APPENDIX B DOCUMENT REVISION HISTORY	68
APPENDIX C NFPA STANDARD	71
APPENDIX D JOB AIDS	71
D.1 Abbreviations Used in Fire Protection Tables	71
D.2 Fire Protection Illustrations	72
D.2.1 In-Rack Layouts	72
D.2.2 Fire Protection Schemes	120
APPENDIX E STEEL COLUMN PROTECTION	141
APPENDIX F CLASSIFICATION OF LIQUIDS THAT BURN	141
F.1 Ignitable Liquid Classification Schemes	141

List of Figures

Fig. 2.2.1.1. Location and construction of ignitable liquid storage buildings and cutoff rooms	11
Fig. 2.2.3.1.A. Prefabricated ignitable liquid storage building (PILSB)	18
Fig. 2.2.3.2. Ignitable liquid storage locker	19
Fig. 2.4.8.2. Minimum flue space between palletized storage arrays (plan view)	48
Fig. 2.4.8.3.A. Loading aisle draft curtain arrangement (plan view)	49
Fig. 2.4.8.3.B. Loading aisle trench drain arrangement (plan view)	49
Fig. 2.4.9.1. Flue space and walkway layout for on-side barrel storage in racks (plan view)	51
Fig. A.1. Plan view (white area represents open area fraction)	66
Fig. D.2.1.1. Single-row rack sprinkler layout: IBC protection scheme	72
Fig. D.2.1.2. Single-row rack sprinkler layout: IBC protection scheme	73
Fig. D.2.1.3. Double-row rack sprinkler layout: IBC protection scheme	74
Fig. D.2.1.4. Single-row rack sprinkler layout: drum protection scheme	75
Fig. D.2.1.5. Double-row rack sprinkler layout: drum protection scheme	76
Fig. D.2.1.6. Double-row rack sprinkler layout: drum protection scheme	77
Fig. D.2.1.7. Multiple-row rack sprinkler layout: drum protection scheme (elevation view)	78
Fig. D.2.1.8. Multiple-row rack sprinkler layout: drum protection scheme (plan view)	79
Fig. D.2.1.9. Single-row rack sprinkler layout: drum protection scheme	80
Fig. D.2.1.10. Double-row rack sprinkler layout: drum protection scheme	81
Fig. D.2.1.11. Single-row rack sprinkler layout: drum protection scheme	82
Fig. D.2.1.12. Double-row rack sprinkler layout: drum protection scheme	83
Fig. D.2.1.13. Single-row rack sprinkler layout: drum protection scheme	84
Fig. D.2.1.14. Double-row rack sprinkler layout: drum protection scheme	85
Fig. D.2.1.15. Single-row rack sprinkler layout: drum protection scheme	86
Fig. D.2.1.16. Double-row rack sprinkler layout: drum protection scheme	87
Fig. D.2.1.17. Single-row rack sprinkler layout: small metal containers	88
Fig. D.2.1.18. Double-row rack sprinkler layout: small metal containers (with face sprinklers)	89
Fig. D.2.1.19. Double-row rack sprinkler layout: small metal containers (no face sprinklers)	90
Fig. D.2.1.20. Multiple-row rack sprinkler layout: small metal containers (elevation view)	91
Fig. D.2.1.21. Multiple-row rack sprinkler layout: small metal containers (plan view)	92
Fig. D.2.1.22. Single-row rack sprinkler layout: water-miscible liquids in small metal containers	93
Fig. D.2.1.23. Double-row rack sprinkler layout: water-miscible liquids in small metal containers	94

Fig. D.2.1.24. Multiple-row rack sprinkler layout: water-miscible liquids in small metal containers (elevation view)	95
Fig. D.2.1.25. Multiple-row rack sprinkler layout: water-miscible liquids in small metal containers (plan view)	96
Fig. D.2.1.26. Single-row rack sprinkler layout: quick response sprinklers protection scheme	97
Fig. D.2.1.27. Double-row rack sprinkler layout: quick response sprinklers protection scheme	98
Fig. D.2.1.28. Single-row rack sprinkler layout: quick response sprinklers protection scheme	99
Fig. D.2.1.29. Double-row rack sprinkler layout: quick response sprinklers protection scheme	100
Fig. D.2.1.30. Single-row rack sprinkler layout: quick response sprinklers protection scheme	101
Fig. D.2.1.31. Double-row rack sprinkler layout: quick response sprinklers protection scheme	102
Fig. D.2.1.32. Single-row rack sprinkler layout: quick response sprinklers protection scheme	103
Fig. D.2.1.33. Double-row rack sprinkler layout: quick response sprinklers protection scheme	104
Fig. D.2.1.34. Multiple-row rack sprinkler layout: quick response sprinklers protection scheme (plan view)	105
Fig. D.2.1.35. Multiple-row rack sprinkler layout: quick response sprinklers protection scheme (elevation view)	106
Fig. D.2.1.36. Multiple-row rack sprinkler layout: quick response sprinklers protection scheme (plan view)	107
Fig. D.2.1.37. Multiple-row rack sprinkler layout: quick response sprinklers protection scheme (elevation view)	108
Fig. D.2.1.38. Multiple-row rack sprinkler layout: quick response sprinklers protection scheme (plan view)	109
Fig. D.2.1.39. Multiple-row rack sprinkler layout: quick response sprinklers protection scheme (elevation view)	110
Fig. D.2.1.40. Multiple-row rack sprinkler layout: quick response sprinklers protection scheme (plan view)	111
Fig. D.2.1.41. Multiple-row rack sprinkler layout: quick response sprinklers protection scheme (elevation view)	112
Fig. D.2.1.42. Single-row rack storage of water-miscible liquids	113
Fig. D.2.1.43. Double-row rack storage of water-miscible liquids	114
Fig. D.2.1.44. Single-row rack storage of water-miscible liquids	115
Fig. D.2.1.45. Double-row rack storage of water-miscible liquids	116
Fig. D.2.1.46. Single-row rack storage of Group 3 water-miscible liquids	117
Fig. D.2.1.47. Double-row rack storage of Group 3 water-miscible liquids	118
Fig. D.2.1.48. In-rack sprinkler layout for distilled spirits in wooden barrels (plan view)	119
Fig. D.2.1.49. In-rack sprinkler layout for distilled spirits in wooden barrels (elevation view)	119
Fig. D.2.2.1.1. Single-row rack sprinkler layout: fire protection scheme A	121
Fig. D.2.2.1.2. Single-row rack sprinkler layout: fire protection scheme A	122
Fig. D.2.2.1.3. Double-row rack sprinkler layout: fire protection scheme A	123
Fig. D.2.2.1.4. Multiple-row rack sprinkler layout: fire protection scheme A	124
Fig. D.2.2.2.1. Single-row rack sprinkler layout: fire protection scheme B	126
Fig. D.2.2.2.2. Single-row rack sprinkler layout: fire protection scheme B	127
Fig. D.2.2.2.3. Double-row rack sprinkler layout: fire protection scheme B	128
Fig. D.2.2.2.4. Multiple-row rack sprinkler layout: fire protection scheme B	129
Fig. D.2.2.3.1. Single-row rack sprinkler layout: fire protection scheme C	131
Fig. D.2.2.3.2. Single-row rack sprinkler layout: fire protection scheme C	132
Fig. D.2.2.3.3. Double-row rack sprinkler layout: fire protection scheme C	133
Fig. D.2.2.4.1. Single-row rack sprinkler layout: fire protection scheme D	136
Fig. D.2.2.4.2. Single-row rack sprinkler layout: fire protection scheme D	137
Fig. D.2.2.4.3. Double-row rack sprinkler layout: fire protection scheme D	138
Fig. D.2.2.5.1. Single-row rack sprinkler layout: fire protection scheme E	139
Fig. D.2.2.5.2. Double-row rack sprinkler layout: fire protection scheme E	140
Fig. E.1.B. Water spray protection for steel columns	141

List of Tables

Table 2.1.2.2. Water-Miscible Liquid Groupings	7
Table 2.1.3.7.1. Glycol Water Mixtures	10
Table 2.2.1.1. Location and Construction for Ignitable Liquid Storage Areas	11

Table 2.2.1.1. Location and Construction for Ignitable Liquid Storage Areas (continued)	11
Table 2.2.2.1.A. Drainage and Containment Requirements for Liquid Storage in Metal Containers in Cutoff Rooms/Buildings	14
Table 2.2.2.1.A. Drainage and Containment Requirements for Liquid Storage in Metal Containers in Cutoff Rooms/Buildings (continued)	15
Table 2.2.2.1.B. Drainage and Containment Requirements for Liquid Storage in Plastic Containers in Cutoff Rooms/Buildings	16
Table 2.2.2.1.B. Drainage and Containment Requirements for Liquid Storage in Plastic Containers in Cutoff Rooms/Buildings (continued)	17
Table 2.4.2.1 Palletized or Solid-Pile Storage of Ignitable Liquids in Relieving-Style Metal Containers Larger than 60 gal (230 L) and FM Approved Composite IBCs (Note 1)	23
Table 2.4.2.2. Rack Storage of Ignitable Liquids in Relieving-Style Metal Containers Larger than 60 gal (230 L) and FM Approved Composite IBCs (Note 1)	24
Table 2.4.3.1 Rack Storage of Ignitable Liquids in Metal Containers larger than 6.5 gal (25 L) Up to and Including 60 gal (230 L) (Note 1)	26
Table 2.4.3.1 Rack Storage of Ignitable Liquids in Metal Containers larger than 6.5 gal (25 L) Up to and Including 60 gal (230 L) (Note 1) (continued)	27
Table 2.4.3.2. Palletized/Solid-Pile Storage of Ignitable Liquids in metal Containers Larger than 6.5 gal (25 L) Up to and Including 60 gal (230 L) (Apply Table in Accordance with Recommendation 2.4.3.2) (Note 1)	28
Table 2.4.3.2. Palletized/Solid-Pile Storage of Ignitable Liquids in metal Containers Larger than 6.5 gal (25 L) Up to and Including 60 gal (230 L) (Apply Table in Accordance with Recommendation 2.4.3.2) (Note 1) (continued)	29
Table 2.4.4.1.A. Rack Storage of Ignitable Liquid in Metal Containers Up to and Including 6.5 gal (25 L)	31
Table 2.4.4.1.B. Protection for Any Ignitable Liquid in Relieving-Style Metal Containers Up to and Including 6.5 gal (25 L), Excluding Ignitable Liquids with a Boiling Point Below 100°F (38°C) (Note 1)	32
Table 2.4.4.2. Palletized/Solid-Pile Storage of Liquids In Non Relieving-Style Metal Containers Up to and Including 6.5 gal (25 L) (Note 1)	33
Table 2.4.4.3. Shelf Storage of Liquids in Metal Containers Up to and Including 6.5 gal (25 L) (Note 1)	33
Table 2.4.5.1. Fire Protection Criteria for Ignitable Liquids in Plastic or Glass Containers (Note 1)	34
Table 2.4.6.1. Storage of Liquids in Composite IBCs (blow molded bottle in a wire cage on a wood or steel pallet)(Note 1)	36
Table 2.4.7.1. Rack Storage of Liquids in Plastic or Glass Containers with Flash Points Below 200°F (93°C) (Note 1)	37
Table 2.4.7.2.1. Rack Storage of Liquids in Plastic or Glass Containers with Flash Points At or Above 200°F (93°C)(Note 1)	39
Table 2.4.7.2.1. Rack Storage of Liquids in Plastic or Glass Containers with Flash Points At or Above 200°F (93°C) (Note 1) (continued)	40
Table 2.4.7.2.2. Palletized/Solid Pile Storage of Liquids with Closed-Cup Flash Points At or Above 200°F (93°C) in Plastic Containers (Note 1)	41
Table 2.4.7.2.2. Palletized/Solid Pile Storage of Liquids with Closed-Cup Flash Points At or Above 200°F (93°C) in Plastic Containers (Note 1) (continued)	42
Table 2.4.7.3.1. Rack Storage of Group 1, 2, 3, and 4 Water-Miscible Liquids in Plastic or Glass Containers (Note 1)	43
Table 2.4.7.3.1. Rack Storage of Group 1, 2, 3, and 4 Water-Miscible Liquids in Plastic or Glass Containers (Note 1) (continued)	44
Table 2.4.7.3.2. Palletized/Solid Pile Storage of Groups 1 through 4 Water-Miscible Liquids in Plastic or Glass Containers (Note 1)	46
Table 2.4.7.3.2. Palletized/Solid Pile Storage of Groups 1 through 4 Water-Miscible Liquids in Plastic or Glass Containers (Note 1) (continued)	47
Table 2.4.8.5. Palletized Storage of Distilled Spirits with up to 75% Alcohol by Volume in Wooden Barrels	50
Table 2.4.9.3. Rack Storage of Distilled Spirits in Wooden Barrels (Note 1)	52
Table 2.8.1. Electrical Equipment Ratings and Lift Truck Ratings for Ignitable Liquids Storage Occupancies	55
Table D.2.2.1.3. Liquid-Container Combinations for Use With Scheme A Without Balancing the Ceiling and In-rack Designs	120
Table D.2.2.1.4. Liquid-Container Combinations for Use With Scheme A Where Balancing the Ceiling and In-rack Designs is Needed	121

1.0 SCOPE

This data sheet covers the storage of chemically stable liquids that can burn (i.e., ignitable liquids) stored in portable, non-pressurized metal, glass, fiberboard, plastic, or composite containers of any size.

For the purposes of this document, the term "ignitable liquid" is used for any liquid that has a measurable flash point. The term "flash point" refers to the closed-cup flash point unless stated otherwise.

This data sheet does not address the following subjects:

- A. The dispensing of ignitable liquids. Use Data Sheet 7-32, *Ignitable Liquid Operations*, to evaluate all ignitable liquid dispensing operations.
- B. Combustible solids or unstable liquids (i.e., liquids that have the potential to self-react or polymerize).
- C. Liquids that have a flash point but no fire point (see Appendix A).
- D. Aerosols. See Data Sheet 7-31, *Storage of Aerosol Products*.
- E. Reactive chemicals, including water-reactive and pyrophoric materials.
- F. Stationary tanks. See Data Sheet 7-88, *Outdoor Ignitable Liquid Storage Tanks*, and 7-32, *Ignitable Liquid Operations* (for internal ignitable liquid storage tanks).
- G. Compressed or flammable liquefied gases. See Data Sheet 7-50, *Compressed Gases in Portable Cylinders*; Data Sheet 7-53, *Liquefied Natural Gas (LNG)*; and Data Sheet 7-55, *Liquefied Petroleum Gas (LPG) in Stationary Installations*.

1.1 Hazard

Ignitable liquids in sealed containers create many different fire scenarios. With metal containers, there is the potential for the violent failure of the container, or jetting if it is not adequately cooled. It is nearly impossible to prevent the failure of a plastic container filled with an ignitable liquid, which creates the potential for the development of a large growing pool fire.

Apart from the type of fire hazard that can be created, it does not take a lot of ignitable liquid storage to create an unacceptably large fire in a general purpose warehouse. Full-scale fire tests have shown that even a relatively small quantity of ignitable liquid can quickly overwhelm a sprinkler system designed for general storage.

1.2 Changes

October 2020. This document has been completely revised. Major changes include the following:

- A. Revised the definition of "ignitable liquid" to be consistent with Data Sheet 7-32, *Ignitable Liquid Operations*.
- B. Provided a definition for very high flash point liquids (in the atypical liquids section) to replace the previous guidance for liquids with a flash point at or above 450°F (232°C). As part of this change, the flash point threshold has been lowered to 414°F (212°C).
- C. Added guidance for the storage and protection of FM Approved composite intermediate bulk containers.
- D. Revised figure (Fig. 2.2.1.1) and table (Table 2.2.1.1) for location and construction of ignitable liquid storage areas.
- E. Clarified the intent of drainage and containment (Section 2.2.2 and Tables 2.2.2.1.A and 2.2.2.1.B).

- F. Clarified guidance for FM Approved prefabricated ignitable liquids storage buildings (PILSBs) and storage lockers (Section 2.2.3).
- G. Revised ventilation recommendations. Ventilation is now only required for storage occupancies containing liquids with a boiling point below 100°F (38°C), storage occupancies with poorly maintained and leaking containers, and storage occupancies with dispensing operations (Section 2.3.2).
- H. Added guidance on flue spaces (Section 2.3.3) that is aligned with Data Sheet 8-9.
- I. Added a new section to consolidate guidance on in-rack sprinklers (Section 2.4.1.5).
- J. Added protection guidance for rack storage of metal drums where the roof height exceeds 30 ft (9.1 m) (Sections 2.4.3.1.1 and 2.4.4.1.1).
- K. Revised the options for rack storage protection for any flash point, uncartoned, small metal containers (6.5 gal [25 L] or less) based on fire testing (Table 2.4.4.1.A). Face sprinklers are now recommended for double-row and multiple-row rack storage.
- L. Added guidance for shelf storage of ignitable liquids in plastic or glass containers (Section 2.4.5.2).
- M. Added protection for propylene glycol and ethylene glycol in composite IBCs (Table 2.4.6.1) and plastic drums (Table 2.4.7.3.2).
- N. Added protection criteria for rack and palletized storage of distilled spirits in wooden barrels (Sections 2.4.8 and 2.4.9).
- O. Revised electrical equipment ratings (Table 2.8.1).
- P. Clarified guidance on when balancing is recommended with Scheme A (Section D.2.2.1).
- Q. Added more figures for protection options (e.g., for single-row racks) and revised other figures to provide consistency.
- R. Renumbered tables and figures based on section numbers.

2.0 LOSS PREVENTION RECOMMENDATIONS

2.1 Introduction

Use FM Approved equipment, materials, and services whenever they are applicable and available. For a list of products and services that are FM Approved, see the *Approval Guide*, an online resource of FM Approvals.

2.1.1 General

- 2.1.1.1 Apply all elements of this data sheet to liquids that have a flash point and a fire point.
- 2.1.1.2 Arrange, locate, and protect dispensing operations in accordance with Data Sheet 7-32, *Ignitable Liquid Operations*.
 - 2.1.1.2.1 Arrange cutoff rooms or detached buildings with both storage and dispensing to meet all applicable recommendations in both this data sheet and Data Sheet 7-32.
- 2.1.1.3 Do not mix storage of ignitable liquids with oxidizers, peroxides, or flammable gas.
- 2.1.1.4 Any level of aerosol product may be stored with ignitable liquids in maximum 1 qt (0.9 L) metal containers as long as the provided fire protection scheme, isolation, and construction features are fully adequate for both storage types. See Data Sheet 7-31, *Storage of Aerosol Products*, for aerosols.
- 2.1.1.5 Handle, store, and protect partially full ignitable liquid containers as full containers.
- 2.1.1.6 Store empty ignitable liquid containers that have not been cleaned and purged outside the facility.
- 2.1.1.7 Do not use plastic pallets for storage of ignitable liquids unless the protection scheme specifies that they are acceptable.
- 2.1.1.8 FM Approved composite intermediate bulk containers (IBC) filled with liquids having a flash point greater than or equal to 200°F (93°C) may be protected as metal containers in accordance with this data sheet.

2.1.2 Liquid Evaluation

2.1.2.1 Evaluate all ignitable liquids, mixtures, emulsions, and semi-solids in storage in accordance with this data sheet.

2.1.2.1.1 Evaluate emulsions (mixtures that do not separate) having more than 20% ignitable liquid in a water base in accordance with this data sheet and their flash point.

2.1.2.1.2 Treat emulsions with up to 20% ignitable liquid in a water base as a liquid that will not create a pool fire regardless of flash or fire point. These liquids are not covered by this data sheet.

2.1.2.2 Evaluate and group water-miscible ignitable liquids in accordance with Table 2.1.2.2 See Section 3.2.1 for further information.

Table 2.1.2.2. Water-Miscible Liquid Groupings

Group	Volume Percent Range			
	Alcohol (Note 1)	Acetone	Ethylene Glycol, Propylene Glycol (Note 2)	Acetic Acid
1	71% - 100%	16% - 80%	DNA	DNA
2	51% - 70%	DNA	DNA	DNA
3	31% - 50%	DNA	>80%	≥90%
4	21% - 30%	DNA	DNA	DNA
5	0% - 20%	0% - 15%	≤80%	<90%

Notes:

1. Methyl alcohol, ethyl alcohol, n-propyl alcohol, isopropyl alcohol, tert-butyl alcohol, allyl alcohol.
2. For glycol-water mixtures less than or equal to 80 glycol, see Section 2.1.3.7.
3. DNA = does not apply.

2.1.2.2.1 From a fire hazard standpoint, do not treat Group 5 water-miscible liquids as ignitable liquids.

2.1.2.2.2 Treat a mixture of alcohol and another water miscible liquid by adding up the percentages and basing the group on the total alcohol percentage. For example, treat a mixture comprised of 40% alcohol, 30% propylene glycol, and 30% water as 70% alcohol (Group 2).

2.1.2.3 Protect viscous mixtures (see Section 3.2.3 for definition) of ignitable liquids with solids as follows:

- A. When in metal containers, protect as a Class 3 commodity per the recommendations in Data Sheet 8-9, *Storage of Class 1, 2, 3, 4 and Plastic Commodities*.
- B. When in plastic containers, protect as a cartoned unexpanded plastic per the recommendations in Data Sheet 8-9, *Storage of Class 1, 2, 3, 4 and Plastic Commodities*.

2.1.2.4 Protect materials that are solid at room temperature (68°F [20°C]) in accordance with the applicable FM Global data sheet.

2.1.3 Atypical Ignitable Liquids

2.1.3.1 Very High Flash Point Liquids

2.1.3.1.1 Treat liquids that meet one of the following criteria as very high flash point liquids:

- A. Unheated liquids with a flash point at or above 414°F (212°C).
- B. Heated liquids with a flash point at or above 414°F (212°C) that have an operating temperature that meets the following equation:

$$\text{Closed cup flash point} - \text{operating temperature} > 324^\circ\text{F} (180^\circ\text{C})$$
- C. Vegetable oils and fish oils with a closed cup flash point of 450°F (232°C) and higher that are heated to less than or equal to 150°F (65°C).

2.1.3.1.2 Confirm the closed-cup flash point of the stored liquid using one of the following test methods:

- ASTM D56, *Standard Test Method for Flash Point by Tag Closed Tester*

- ASTM D93, *Standard Test Methods for Flash Point by Pensky-Martens Closed Cup Tester*
- ISO 2719, *Petroleum Products and Lubricants - Determination of Flash Point - Pensky-Martens Closed Cup Method*

2.1.3.1.2.1 Repeat the test three times. If the closed-cup flash point is at or above 414°F (212°C) for the average of all three tests, protect the liquid in accordance with this data sheet.

2.1.3.1.3 Treat very high flash point liquids that have the potential for a sustained spray fire or a 3D spill fire in accordance with the recommendations for liquids with a flash point at or above 200°F (93°C) in Data Sheet 7-32, *Ignitable Liquid Operations*.

2.1.3.1.4 Protect very high flash point liquids that are stored in plastic, glass, or metal containers of less than 40 gal (150 L) in accordance with the fire protection tables in this data sheet.

2.1.3.1.5 Protect very high flash point liquids that are stored in fixed steel tanks as follows:

- A. Provide a curb around the tank sized for the full contents of the tank. The curb may be adjacent to surrounding occupancies. Drainage and a cutoff room are not needed.
- B. Provide ceiling sprinklers and design to protect the surrounding occupancy. Use a minimum ceiling sprinkler design of not less than 7 psi (0.5 bar) using twenty-five (25) K8.0 (K115) sprinklers if standard spray sprinklers are provided.

2.1.3.1.6 Protect very high flash point liquids that are stored in portable metal containers of 40 gal (150 L) or more as follows:

- A. Store rack or palletized storage in locations 1 through 5 per Figure 2.2.1.1.
- B. Drainage or containment is not needed.
- C. Do not vertically mix liquid storage with solid commodities in palletized or rack arrays.
- D. Provide a minimum of 5 ft (1.5 m) horizontal clearance between liquid and non-liquid storage.
- E. Provide ceiling sprinklers and design to protect the surrounding occupancy. Use a minimum ceiling sprinkler design of not less than 7 psi (0.5 bar) using twenty-five (25) K8.0 (K115) sprinklers if standard spray sprinklers are provided.

2.1.3.1.7 Protect very high flash point liquids that are stored in 40 to 60 gal (150 to 230 L) plastic containers as follows:

- A. Store in locations 1 through 5 per Figure 2.2.1.1.
- B. Drainage or containment is not needed.
- C. Do not vertically mix liquid storage with solid commodities in palletized or rack arrays.
- D. Provide a minimum of 10 ft (3 m) horizontal clearance between liquid and non-liquid storage.
- E. For single-pallet-high container storage, provide sprinkler protection over the storage designed to provide at least 7 psi (0.5 bar) using twenty-five (25) K11.2 (K160) sprinklers if standard spray sprinklers are provided. For higher storage, protect as an uncartoned, unexpanded plastic per Data Sheet 8-9, *Storage of Class 1, 2, 3, 4, and Plastic Commodities*.

2.1.3.1.8 Protect very high flash point liquids that are stored in composite IBCs (only blow-molded plastic bottles in wire cages with wooden or steel pallets) as follows:

- A. Store in locations 1 through 5 per Figure 2.2.1.1.
- B. Provide a curb around the IBC storage area sized for the contents of four IBCs. Drainage is not needed.
- C. Do not vertically mix liquid storage with solid commodities in palletized or rack arrays.
- D. There are no storage height limitations.
- E. Provide a minimum of 10 ft (3 m) horizontal clearance between liquid and non-liquid storage.
- F. Provide ceiling sprinklers and design to protect the surrounding occupancy. Use a minimum ceiling sprinkler design of not less than 7 psi (0.5 bar) using twenty-five (25) K8.0 (K115) sprinklers if standard spray sprinklers are provided.

2.1.3.1.9 Protect very high flash point liquids that are stored in bag-in-box style IBCs (corrugated board boxes on wooden pallets with plastic bags of some type in the box) as follows:

- A. Store in locations 1 through 5 per Figure 2.2.1.1.
- B. Provide a curb around the IBC storage area sized for the contents of twelve IBCs. Drainage is not needed.
- C. Do not vertically mix liquid storage with solid commodities.
- D. Limit the storage arrangement to 2 high palletized IBCs. A rack storage option does not exist at this time.
- E. Provide a minimum of 10 ft (3 m) horizontal clearance between liquid and non-liquid storage.
- F. Provide ceiling sprinklers and design to protect the surrounding occupancy. Use a minimum ceiling sprinkler design of not less than 7 psi (0.5 bar) using twenty-five (25) K8.0 (K115) sprinklers if standard spray sprinklers are provided.

2.1.3.1.10 Protect very high flash point liquids that are stored in composite IBCs fitted with plastic pallets, or all-plastic IBCs as follows:

- A. Store in locations 1 through 5 per Figure 2.2.1.
- B. Provide containment around the IBC storage area sized for the contents of all stored IBCs. Drainage is not needed.
- C. Do not store in racks.
- D. Limit storage height to one unit high.
- E. Provide a minimum of 10 ft (3 m) horizontal clearance between liquid and non-liquid storage.
- F. Provide sprinkler protection over the storage designed for exposed expanded plastic in accordance with Data Sheet 8-9, *Storage of Class 1, 2, 3, 4, and Plastic Commodities*.

2.1.3.2 Silicone Fluids and Silicone Emulsions

2.1.3.2.1 Treat silicone emulsions consisting of up to 50% silicone fluid in water as non-ignitable liquids.

2.1.3.2.2 Protect straight-chain silicone fluids (also referred to as siloxanes or methyl siloxanes) that have a closed-cup flash point of 414°F (212°C) or greater as very high flash point liquids in accordance with this data sheet.

2.1.3.2.3 Protect all other silicone fluids (e.g., methylhydrogen siloxanes, organofunctional silanes) as an ignitable liquids in accordance with their flash point and this data sheet.

2.1.3.3 Paste Ink

2.1.3.3.1 Protect paste ink storage in accordance with Data Sheet 7-96, *Printing Plants*.

2.1.3.4 Water-Based Polyurethane Foam Packaging Systems

2.1.3.4.1 Apply this section only to water-based packaging systems comprised of the following two components:

- Polymethylene polyphenyl isocyanate, diphenylmethane diisocyanate, or polymeric MDI or PMDI
- Polyol

2.1.3.4.2 Do not treat polyol as an ignitable liquid unless it is blended with oil or any other ignitable liquid, such as glycols or glycerines (the polyol used in packaging systems is usually not blended with oil or other ignitable liquids).

2.1.3.4.3 Protect storage of PMDI in metal or plastic containers in accordance with its flash point and this data sheet.

2.1.3.4.4 For areas where PMDI and polyol are used, adhere to the recommendations in Data Sheet 7-32, *Ignitable Liquid Operations*.

2.1.3.5 Butterfat or Milk Fat

2.1.3.5.1 Protect butterfat or milk fat as a very high flash point liquid in accordance with this data sheet.

2.1.3.6 Unsaturated Polyester Resin (UPR)

2.1.3.6.1 Protect UPR mixtures with 50% or less styrene in a palletized array up to 3 relieving-style drums (10 ft [3 m]) high without a foam-water sprinkler system (see Table 2.4.3.2 and table note 3).

2.1.3.6.2 Apply all other construction, containment, drainage, and ignition source control recommendations based on the container size and mixture flash point.

2.1.3.6.3 Protect other container sizes of UPR or UPR with higher styrene content based on the container and the liquid flash point in accordance with this data sheet.

2.1.3.7 Propylene and Ethylene Glycol Mixtures

2.1.3.7.1 Use Table 2.1.3.7.1 to determine the recommended fire protection for glycol (propylene or ethylene) and glycol-water mixtures.

Table 2.1.3.7.1. Glycol Water Mixtures

<i>Glycol Content</i>	<i>Protection</i>
>80%	Protect as a Group 3 water-miscible liquid.
≤80% and >35%	<p>Plastic/Glass Containers: Protect as a cartoned unexpanded plastic.</p> <p>Metal Containers: Protect for the provided packaging.</p>
≤35%	<p>Plastic/Glass Containers: Protect as a non-ignitable liquid in a plastic container.</p> <p>Metal Containers: Protect for the provided packaging.</p>

2.1.3.8 Semi-Solid Liquids

2.1.3.8.1 Protect butter or margarine in any container as a Class 3 commodity using Data Sheet 8-9.

2.1.3.8.2 Protect liquid salad dressings with less than 50% oil content in any packaging as a Class 3 commodity using Data Sheet 8-9.

2.1.3.8.3 Protect any semi-solid oil-based product (e.g., shortening, deep-frying fat, grease) in accordance with its measured flash point and this data sheet.

2.2 Construction and Location**2.2.1 General**

2.2.1.1 Segregate ignitable liquid storage from occupancies not designed for ignitable liquid hazards using outdoor locations, detached buildings, or cutoff rooms in accordance with Figure 2.2.1.1, Table 2.2.1.1, and this section (2.2.1).

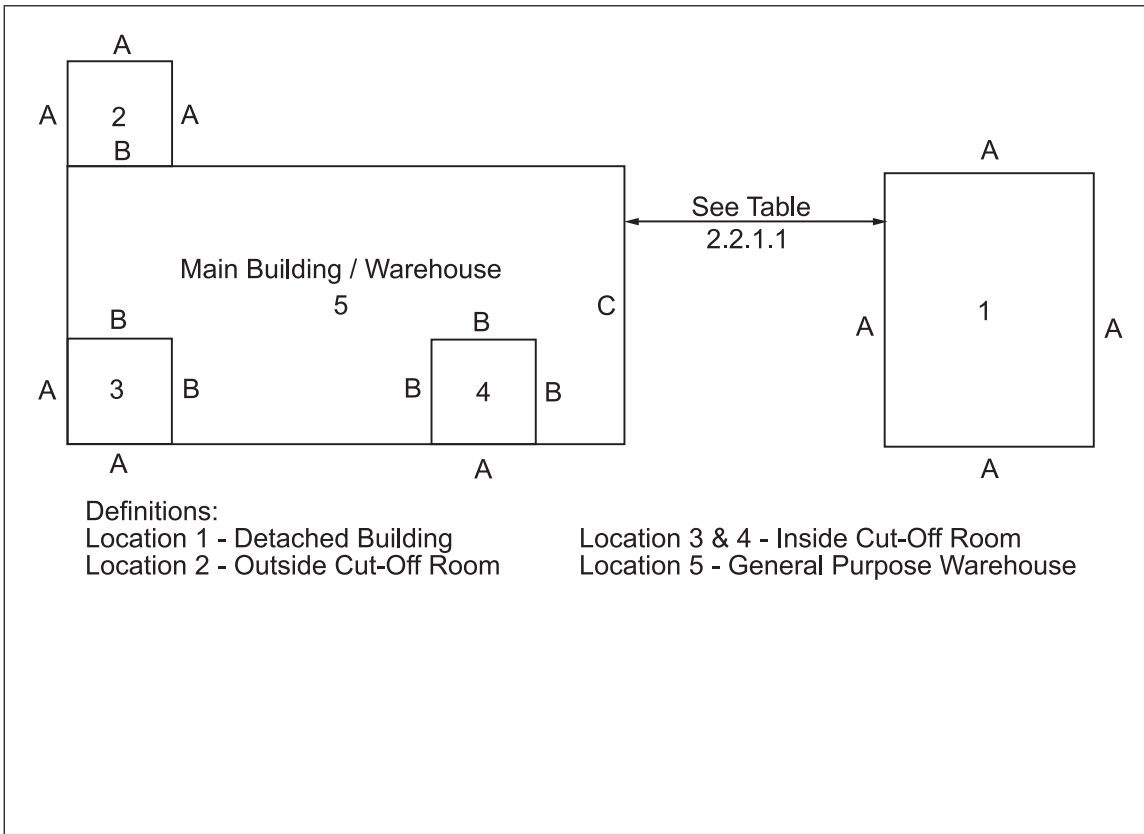

Fig. 2.2.1.1. Location and construction of ignitable liquid storage buildings and cutoff rooms

Table 2.2.1.1. Location and Construction for Ignitable Liquid Storage Areas

Container Type	Flash Point, Liquid Type	Container Size	Storage Location (Note1)	Wall Location	Construction Type (Note 2) or Fire Rating (Note 3)
Any	Any	Any	Distance from main building > 50 ft (15 m)	C	Any
				A	Any
			Distance from main building 25 ft (7.5 m) to 50 ft (15 m)	C	NC
				A	Any
			Distance from main building <25 ft (7.5 m)	C	1 hour
				A	Any
Metal	Any	≤ 6.5 gal (25 L)	2, 3, 4, 5	A, B, C	NC
		> 6.5 gal (25 L)	2, 3, 4	A	NC
				B	1 hour
	Very high flash point	≥ 40 gal (150L)	2, 3, 4, 5	A, B, C	NC
	SG > 1	> 6.5 gal (25 L)	2, 3, 4, 5	A, B	NC
FM Approved composite IBC	≥200°F (93°C)	Any	2, 3, 4	A	NC
				B	NC

Table 2.2.1.1. Location and Construction for Ignitable Liquid Storage Areas (continued)

Container Type	Flash Point, Liquid Type	Container Size	Storage Location (Note 1)	Wall Location	Construction Type (Note 2) or Fire Rating (Note 3)
Plastic, Glass, or Other Combustible Containers	≥ 200°F (93°C)	≤ 6.5 gal (25 L)	2, 3, 4, 5	A, B, C	NC
		> 6.5 gal (25 L)	2, 3, 4	A	NC
				B	2 hour
	Water-miscible	≤ 1 gal (4 L)	2, 3, 4, 5	A, B, C	NC
		> 1 gal (4 L) and ≤ 60 gal (230 L)	2, 3, 4	A	NC
				B	1 hour
		> 60 gal (230 L)	2, 3, 4	A	NC
				B	2 hour
		<200°F (93°C)	≤ 2 oz (60 ml)	2, 3, 4, 5	A, B, C
	> 2 oz (60 ml)		2, 3, 4	A	NC
				B	2 hour
	Very high flash point	≥ 40 gal (150L)	2, 3, 4, 5	A, B, C	NC

Notes:

- Liquid package combinations in Location 5 need to be protectable by protection Tables within this data sheet, but not including Table 2.4.5.1.
- NC = Noncombustible.
- Fire ratings are per ASTM E119 ratings or local code equivalent.

2.2.1.3 Locate storage areas on ground floors.

2.2.1.4 Construct outdoor locations, detached buildings or cutoff rooms that store ignitable liquids in accordance with Figure 2.2.1.1 and Table 2.2.1.1. Note that Table 2.2.1.1 makes the following assumptions:

- Both the exposing building/room and the exposed building are adequately sprinklered.
- An adequate fire service response is present.

2.2.1.4.1 For any storage requiring cutoff per Table 2.2.1.1 and protected in accordance with the Tables within this data sheet, construct cutoff rooms and their walls as follows:

- Where recommended in Table 2.2.1.1, provide fire rated walls per ASTM E119, *Standard Test Methods for Fire Tests of Building Construction and Materials* or local equivalent.
- Design walls to be liquid-tight so released liquids (e.g., ignitable liquids, sprinkler discharge, inside hose streams) will be contained.
- Design walls for the hydraulic pressure created by the contained liquid level.
- Provide at least one outside access for the cutoff room.
- Protect necessary interior openings with a properly fire-rated, normally closed, automatically closing fire door. Locate the fire door on the storage side of the wall. A less desirable alternative is to arrange a normally open fire door to automatically close actuated by a fire inside or directly outside the room.
- For any storage requiring cutoff per Table 2.2.1.1 and protected in accordance with Table 2.4.5.1, in addition to items A through E above, construct cutoff rooms and their walls as follows:
 - Provide 2-hour fire-rated construction.
 - When a direct connection is needed between the cutoff room and the main building, provide an enclosed walkway designed to prevent the flow of liquid from entering the main building if the drainage and/or containment systems are overwhelmed.
 - If the liquid pool fire will affect all four sides of a steel column located inside a detached building or cutoff room, protect columns using the guidance in Appendix E.

2.2.1.4.2 Construct roofs and ceilings as follows:

- For cutoff rooms that have ceilings below the main building's roof, provide a ceiling assembly that has the same fire resistance as the interior walls of the cutoff room.

B. For detached buildings or cutoff rooms that share the main building roof, provide a non-combustible roof, an FM Approved Class 1 steel deck roof or an FM Approved insulated metal panel roof in accordance with Data Sheet 1-29, *Roof Deck Securement and Above-Deck Roofing Components*.

C. For cutoff rooms that have wooden roof assemblies, sheath the wooden roof with material that achieves the same fire resistance as needed for the interior walls of the cutoff room.

D. Provide sprinklers in any combustible spaces in accordance with Data Sheet 1-12, *Ceilings and Concealed Spaces*.

2.2.1.4.3 Provide impact protection for fire rated walls constructed of low- impact strength materials (e.g., gypsum board) to a height equal to the storage height when storage is adjacent to the wall, or 5 ft (1.5 m) when the storage is away from the wall.

2.2.1.4.4 Provide noncombustible wall construction with no openings for the wall on the main building/warehouse side for 10 ft (3 m) beyond each side of an exterior cutoff room (i.e., wall B for location 2 in Figure 2.2.1.1).

2.2.1.5 Arrange interior or exterior cutoff rooms as follows:

A. Locate cutoff rooms next to loading/shipping docks to prevent the creation of an ignitable liquid fire hazard along liquid transportation routes in buildings that are not protected for the hazard.

B. Provide the cutoff rooms with their own shipping doors.

C. Provide space in the cutoff rooms for staging products before they are placed in storage or while they are awaiting shipment.

2.2.1.6 For loading docks on which ignitable liquid containers are staged, provide construction, protection, containment, and emergency drainage as recommended by this data sheet. The term "staged" in this context excludes uninterrupted movement of containers from inside the shipping vehicle directly to the properly designed storage area.

2.2.1.7 Provide self-supporting rack structures for distilled spirit barrel storage warehouses. Follow guidance in Section 2.5.3 for operation and maintenance at these warehouses.

2.2.2 Drainage and Containment

2.2.2.1 For cutoff rooms or buildings in which ignitable liquids are stored, provide emergency drainage and/or containment in accordance with Table 2.2.2.1.A or 2.2.2.1.B.

2.2.2.2 For liquids with a viscosity greater than 10,000 cP, containment without emergency drainage is sufficient.

2.2.2.3 For locations with multiple ignitable liquid storage warehouses, provide grading between the warehouses so liquids do not flow to adjacent buildings.

2.2.2.4 Design emergency drainage and containment systems in accordance with Data Sheet 7-83, *Drainage and Containment Systems for Ignitable Liquids*, to prevent the flow of liquid into adjacent areas of the facility that are not protected for an ignitable liquid fire hazard.

2.2.2.5 Do not include hose stream demands in the drainage or containment design unless inside hose stations are provided.

2.2.2.6 Use 50 gpm (190 L/min) for one hose station, or 100 gpm (380 L/min) for more than one in the fire area.

2.2.2.7 For special protection systems, containment without emergency drainage is sufficient.

2.2.2.7.1 Arrange containment to prevent the flow of liquid into adjacent areas within the facility that are not protected for an ignitable liquid fire hazard for at least 20 minutes.

Table 2.2.2.1.A. Drainage and Containment Requirements for Liquid Storage in Metal Containers in Cutoff Rooms/Buildings

Container Type	Flash Point, Liquid Type	Container Size	Drainage and/or Containment Options and Alternatives
Metal	Very high flash point	<40 gal (150 L)	Treat as > 200°F (93°C)
		≥40 gal (150 L)	See Section 2.1.3.1.
	≥200°F (93°C)	≤6.5 gal (25 L)	None
		>6.5 gal (25 L)	1. Provide emergency drainage and containment, or containment alone arranged to prevent spilled liquid plus actual sprinkler discharge (Note 1) from spreading to areas not protected for an ignitable liquid fire hazard outside the room/building of origin for 30 minutes. Provide no less than 3 in. (7.6 cm) of containment across all interior openings. Or 2. Provide containment and a special protection system as per this data sheet. Design the containment designed to keep spilled liquid plus actual sprinkler discharge (Note 1) plus special protection system discharge from spreading to areas not protected for an ignitable liquid fire hazard outside the room/building of origin for 20 minutes. Provide no less than 3 in. (7.6 cm) of containment across all interior openings.
	<200°F (93°C)	≤6.5 gal (25 L)	None
		>6.5 gal (25 L) and ≤60 gal (230 L)	1. Provide emergency drainage and containment or containment alone arranged to prevent spilled liquid plus actual sprinkler discharge (Note 1) from spreading to areas not protected for an ignitable liquid fire hazard outside the room/building of origin for 30 minutes. Provide no less than 3 in. (7.6 cm) of containment across all interior openings. Or 2. Provide containment and a special protection system as per this data sheet. Design the containment to keep spilled liquid plus actual sprinkler discharge (Note 1) plus special protection system discharge from spreading to areas not protected for an ignitable liquid fire hazard outside the room/building of origin for 20 minutes. Provide no less than 3 in. (7.6 cm) of containment across all interior openings.
		>60 gal (230 L)	1. Provide emergency drainage and containment designed to limit the liquid pool to no more than the sprinkler operating area, to prevent spilled liquid plus actual sprinkler discharge (Note 1) from spreading to areas not protected for an ignitable liquid fire hazard outside the room/building of origin. Provide no less than 3 in. (7.6 cm) of containment across all interior openings. Or 2. Provide containment and a special protection system as per this data sheet. Design containment to keep spilled liquid plus actual sprinkler discharge (Note 1) plus special protection discharge from spreading to areas not protected for an ignitable liquid fire hazard outside the room/building of origin for 20 minutes. Provide no less than 3 in. (7.6 cm) of containment across all interior openings.
	SG >1	≤6.5 gal (25 L)	None
		>6.5 gal (25 L)	Provide containment sized to hold the largest expected ignitable liquid release plus an additional 2 in. (51 mm) of freeboard. Limit the containment footprint to an area no larger than the sprinkler operating area.

Table 2.2.2.1.A. Drainage and Containment Requirements for Liquid Storage in Metal Containers in Cutoff Rooms/Buildings (continued)

Container Type	Flash Point, Liquid Type	Container Size	Drainage and/or Containment Options and Alternatives
FM Approved composite IBC	≥200°F (93°C)	Any	1. Provide emergency drainage and containment, or containment alone arranged to prevent spilled liquid plus actual sprinkler discharge (Note 1) from spreading to areas not protected for an ignitable liquid fire hazard outside the room/building of origin for 30 minutes. Provide no less than 3 in. (75 mm) of containment across all interior openings. Or 2. Provide containment and a special protection system per this data sheet. Design the containment designed to keep spilled liquid plus actual sprinkler discharge (Note 1) plus special protection system discharge from spreading to areas not protected for an ignitable liquid fire hazard outside the room/building of origin for 20 minutes. Provide no less than 3 in. (75 mm) of containment across all interior openings.

Note: 1. The amount of water that will actually discharge from the sprinklers based on the available water supply, not the theoretical sprinkler discharge.

Table 2.2.2.1.B. Drainage and Containment Requirements for Liquid Storage in Plastic Containers in Cutoff Rooms/Buildings

Container Type	Flash Point,Liquid Type (Note 1)	Container Size	Drainage and/or Containment Options and Alternatives
Plastic, Glass, or Other Combustible Containers	Very high flash point	<40 gal (150 L)	Treat as > 200°F (93°C)
		≥40 gal (150 L)	See Section 2.1.3.1.
	≥200°F (93°C)	≤6.5 gal (25 L)	None
		>6.5 gal (25 L)	<p>1. Provide emergency drainage and containment arranged to prevent spilled liquid plus actual sprinkler discharge (Note 1) from spreading to areas not protected for an ignitable liquid fire hazard outside the room/building of origin for 30 minutes. Arrange the drains to subdivide the room into the smallest practical drainage areas but no larger than 5000 ft² (465 m²). Provide no less than 3 in. (7.6 cm) of containment across all interior openings. All containers in the cutoff room are expected to fail.</p> <p>Or</p> <p>2. Provide containment and a special protection system as per this data sheet. Design the containment to keep spilled liquid plus actual sprinkler discharge (Note 1) plus special protection system discharge from spreading to areas not protected for an ignitable liquid fire hazard outside the room/building of origin for 20 minutes. Provide no less than 3 in. (7.6 cm) of containment across all interior openings.</p> <p>Or</p> <p>3. For composite IBC storage protected in accordance with Table 2.4.6.1, provide emergency drainage and containment or containment alone arranged to prevent spilled liquid plus actual sprinkler discharge (Note 1) from spreading to areas not protected for an ignitable liquid fire hazard outside the room/building of origin for 30 minutes. Provide no less than 3 in. (7.6 cm) of containment across all interior openings.</p>
	<200°F (93°C)	≤2 oz (60 ml)	None
		> 2 oz (60 ml) and ≤ 1 gal (4 L)	For rack storage protected using Table 2.4.7.1, provide no less than 3 in. (7.6 cm) of containment across all interior openings. For all other storage arrangements, follow the guidance for containers larger than 1 gal (4 L).
> 1 gal (4 L)		<p>1. Provide emergency drainage and containment arranged to prevent spilled liquid plus actual sprinkler discharge (Note 1) from spreading to areas not protected for an ignitable liquid fire hazard outside the room/building of origin for 30 minutes. Arrange the drains to subdivide the room into the smallest practical drainage areas but no larger than 5000 ft² (465 m²). Provide no less than 3 in. (7.6 cm) of containment across all interior openings. All containers in the cutoff room are expected to fail.</p> <p>Or</p> <p>2. Provide containment and a special protection system as per this data sheet. Design the containment to keep spilled liquid plus actual sprinkler discharge (Note 1) plus special protection system discharge from spreading to areas not protected for an ignitable liquid fire hazard outside the room/building of origin for 20 minutes. Provide no less than 3 in. (7.6 cm) of containment across all interior openings.</p>	

Table 2.2.2.1.B. Drainage and Containment Requirements for Liquid Storage in Plastic Containers in Cutoff Rooms/Buildings (continued)

Container Type	Flash Point, Liquid Type (Note 1)	Container Size	Drainage and/or Containment Options and Alternatives
Plastic, Glass, or Other Combustible Containers	Water-miscible Group 1, 2, 3 & 4	≤1 gal (4 L)	None
		>1 gal (4 L) and ≤60 gal (230 L)	For storage protected using Table 2.4.7.3.1 or Table 2.4.7.3.2, provide no less than 3 in. (7.6 cm) of containment across all interior openings. For storage protected using Table 2.4.5.1, follow the guidance for containers larger than 60 gal (230 L).
		Wooden barrels 53 – 130 gal (200 – 500L)	For distilled spirits stored in wooden barrels and protected in accordance with Section 2.4.8 or 2.4.9, arrange warehouses to either fully contain the sprinkler discharge or to direct all release liquids to a safe remote location. If trench drains are used to isolate storage areas, design the trench drains as emergency drainage.
		>60 gal (230 L)	<p>1. Provide emergency drainage and containment arranged to prevent spilled liquid plus actual sprinkler discharge (Note 1) from spreading to areas not protected for an ignitable liquid fire hazard outside the room/building of origin for 30 minutes. Arrange the drains to subdivide the room into the smallest practical drainage areas but no larger than 5000 ft² (465 m²). Provide no less than 3 in. (7.6 cm) of containment across all interior openings. All containers in the cutoff room are expected to fail.</p> <p>Or</p> <p>2. Provide containment and a special protection system as per this data sheet. Design the containment to keep spilled liquid plus actual sprinkler discharge (Note 1) plus special protection system discharge from spreading to areas not protected for an ignitable liquid fire hazard outside the room/building of origin for 20 minutes. Provide no less than 3 in. (7.6 cm) of containment across all interior openings.</p> <p>Or</p> <p>3. For composite IBC storage protected in accordance with Table 2.4.6.1, provide emergency drainage and containment or containment alone arranged to prevent spilled liquid plus actual sprinkler discharge (Note 1) from spreading to areas not protected for an ignitable liquid fire hazard outside the room/building of origin for 30 minutes. Provide no less than 3 in. (7.6 cm) of containment across all interior openings.</p>

Note: 1. The amount of water that will actually discharge from the sprinklers based on the available water supply, not the theoretical sprinkler discharge.

2.2.3 Premanufactured Buildings and Cabinets

2.2.3.1 Use FM Approved prefabricated ignitable liquid storage buildings (PILSBs) as an alternative to a permanently constructed cut-off or detached ignitable liquids storage room, subject to the following limitations:

- A. The unit is designed to fully contain the storage and allows for personnel entry (see Figure 2.2.3.1.A). Liquids stored in these units cannot leak out of the unit because they are fully contained by walls.

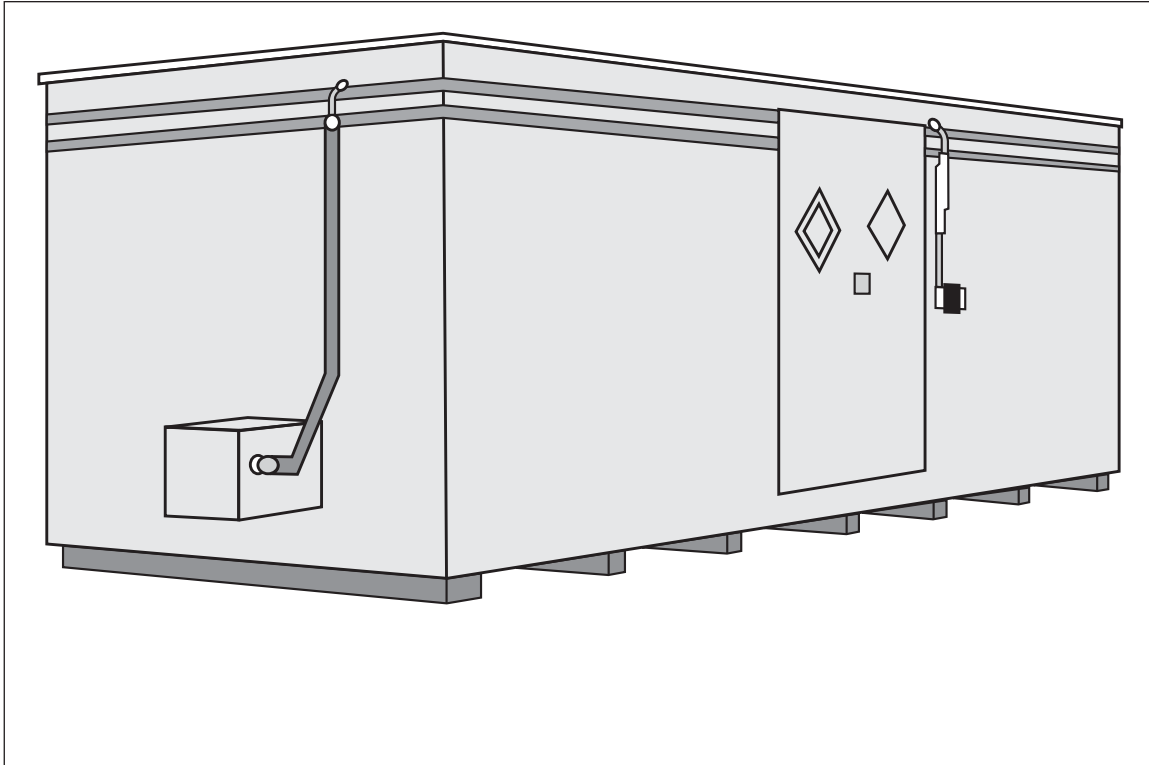

Fig. 2.2.3.1.A. Prefabricated ignitable liquid storage building (PILSB)

- B. Provide all of the active and passive protection features recommended in this data sheet (fire rating, containment and drainage, ventilation, ignition source control, and automatic fire protection) for the PILSB.

- C. Do not use PILSB units with explosion venting inside a building.

2.2.3.2 Use FM Approved ignitable liquid storage lockers for outdoor storage of liquids (see Figure 2.2.3.2).

2.2.3.2.1 If a storage locker is located inside the building, locate the unit in a cut-off room and protect in accordance with this standard or FM Global Property Loss Prevention Data Sheet 7-32 depending on how it is used (i.e., just storage or storage and dispensing).

2.2.3.3 Use FM Approved ignitable liquid storage cabinets to hold limited quantities of ignitable liquids in general-purpose warehouses, subject to the following limitations:

- A. For cabinets designed to hold containers larger than 5 gal (19 L), restrict ignitable liquid quantities to ensure the cabinet will contain the largest expected liquid release (e.g., largest metal container and contents of all plastic containers).
- B. Provide a minimum of 20 ft (6 m) separation between cabinets and non-liquid warehouse areas.
- C. Do not put cabinets within non-liquid rack storage arrangements.
- D. Do not dispense ignitable liquids from containers located in storage cabinets in warehouse occupancies.



Fig. 2.2.3.2. Ignitable liquid storage locker

2.2.4 Outdoor Storage

2.2.4.1 Provide curbs or dikes for storage pads away from important buildings to control any liquid release. However, if the ground is clearly sloped away from important buildings, utilities, fire protection equipment or other storage pads, dikes are not required for property protection purposes.

2.2.4.2 Arrange curbed/diked areas to permit emergency drainage of impounded liquids.

2.2.4.3 Limit storage heights to maintain pile stability.

2.2.4.4 Locate outdoor ignitable liquid storage that exposes buildings in accordance with the separation distances in Table 2.2.1.1. Provide construction for the exposed building in accordance with Table 2.2.1.1.

2.2.4.4.1 For outdoor ignitable liquid storage that is located closer than the recommended space separation distances in Table 2.2.1.1, or if the exposed building's construction does not meet Table 2.2.1.1:

- A. Limit non-relieving-style containers larger than 6.5 gal (25 L) in size to one container high.
- B. Limit relieving-style containers larger than 6.5 gal (25 L) in size to 3 high.
- C. Limit any one dimension of the storage pad/area to 100 ft (30.5 m).
- D. Install a fixed automatic water spray system, arranged to protect the exposed building or facility, in accordance with Section 2.4.1.10 of this data sheet.

2.2.4.5 Treat outdoor storage that is provided with a noncombustible roof for exposure protection as a cutoff room or detached building if the storage arrangements and sprinkler designs are in accordance with Section 2.4, and the construction features of the exposed building are in accordance with Figure 2.2.1.1 and Table 2.2.1.1.

2.2.4.6 Provide protection for yard storage in accordance with Section 2.4.10.

2.3 Occupancy

2.3.1 Housekeeping

2.3.1.1 Establish and implement a housekeeping program for areas storing ignitable liquids that adheres to the highest standards and includes the following elements.

- A. Clean up spills promptly.
- B. Keep waste materials in FM Approved oily waste cans.
- C. Remove waste daily.
- D. Maintain adequate aisles to permit unobstructed movement of personnel and access for firefighting.
- E. Do not store other combustibles in the area nor permit any material that might wash into or plug drains.
- F. Keep outdoor storage areas clear of grass, weeds, and other combustibles.

2.3.2 Ventilation

2.3.2.1 Provide continuous low-level ventilation designed in accordance with the guidance provided in Data Sheet 7-32 if the following scenarios are present:

- A. For storage occupancies containing liquids with a boiling point below 100°F (38°C) provide a design of 0.5 cfm/ft² (0.15 m³/min/m²).
- B. For storage occupancies with poorly maintained and leaking containers or occupancies with dispensing operations use the ventilation rate recommended in Data Sheet 7-32.

2.3.3 Flue Spaces

2.3.3.1 Provide vertically aligned, minimum net 6 in. (150 mm) wide open flue spaces around all four sides of all product loads within storage racks.

2.4 Protection

2.4.1 General

2.4.1.1 Provide storage automatic sprinklers over all areas storing, staging, or used for transporting ignitable liquids.

2.4.1.1.1 Extend the sprinkler protection to the physical limits of the area.

2.4.1.2 Use a wet, pre-action, or deluge system.

2.4.1.3 For unheated areas, use one of the following:

- A. A deluge sprinkler system. See 2.4.1.6.1 for design guidance.
- B. A dry sprinkler system. Use a sprinkler design area equal to the cutoff room or building floor area regardless of what is provided in the protection tables.
- C. A pre-action system. See 2.4.1.6.2 for design guidance.

2.4.1.4 Install sprinkler systems in accordance with Data Sheet 2-0, *Installation Guidelines for Automatic Sprinklers*. Specific installation guidance provided in this data sheet (7-29) supersedes other installation data sheets.

2.4.1.4.1. Arrange sprinklers on a maximum of 100 ft² (9 m²) spacing at the ceiling.

2.4.1.4.2 Arrange sprinklers with a maximum on-line spacing of 10 ft (3 m). A variation of 1 ft (0.3 m) is permitted on either dimension to avoid obstructions by structural elements.

2.4.1.4.3 Where FM Approved K25EC (360EC) sprinklers (pendent or upright) are used, install on a minimum 13 ft (3.9 m) to a maximum 14 ft (4.2 m) linear spacing.

2.4.1.4.4 Do not use ordinary or light hazard, extended coverage sprinklers in liquid storage occupancies.

2.4.1.4.5 Buildings or cutoff areas that are equal to or less than the sprinkler operating area can utilize sprinkler temperatures less than recommended in the tables and faster response times.

2.4.1.4.6 Unless stated otherwise in a protection table, single-row racks are a maximum of 5 ft (1.5 m) deep, and double-row racks are maximum of 9 ft (2.7 m) deep.

2.4.1.5 In-Rack Sprinklers

2.4.1.5.1 Use FM Approved in-rack sprinklers.

2.4.1.5.2 Install in-rack sprinklers in accordance with the figures (see Appendix D.2.1) or schemes (see Appendix D.2.2) referred to in the tables.

A. Locate in-rack sprinklers that are installed in the longitudinal flue space at the junction of transverse flue spaces, within 6 in. (150 mm) of the transverse flue space.

B. Locate face sprinklers within 18 in. (0.5 m) of the rack face unless the protection scheme (Appendix D.2.2) specifies otherwise.

C. For in-rack sprinklers located at every other transverse flue, provide a maximum horizontal spacing of 10 ft (3 m) and a minimum horizontal spacing of 4 ft (1.2 m).

D. For in-rack sprinklers located at every transverse flue, provide a maximum horizontal spacing of 5 ft (1.5 m) and a minimum horizontal spacing of 2 ft (0.6 m).

E. Locate in-rack sprinkler piping behind horizontal rack members to minimize the potential for damage.

F. To protect the flue space created between a single row rack and a wall located with 1 ft (0.3 m) horizontally of the rack structure, position the in-rack sprinkler outside the footprint of the single row rack structure as detailed within Data Sheet 8-9, *Storage of Class 1, 2, 3, 4 and Plastic Commodities*.

2.4.1.5.3 Balance the ceiling and in-rack demands at their point of connection unless using a protection scheme that specifically says the systems do not need to be balanced.

2.4.1.5.4 Provide a minimum discharge pressure of 10 psig (0.7 bar) for in-rack sprinkler designs where the in-rack sprinkler has a K factor ≥ 11.2 (161). Where the in-rack sprinkler has a K factor < 11.2 (161), provide a minimum discharge pressure of 7 psig (0.5 bar).

2.4.1.6 Detector Spacing for Interior Deluge or Pre-action Sprinkler Systems

2.4.1.6.1 Deluge Systems

A. Install pilot sprinklers the same as ceiling sprinklers.

B. Install electric or pneumatic devices under smooth ceilings in accordance with the manufacturer's specifications, the requirements listed in the *Approval Guide* for the particular model, and Data Sheet 5-48, *Automatic Fire Detection*.

2.4.1.6.2 Pre-Action Systems

A. Install electric or pneumatic detectors at a spacing of one-half the listed linear detector spacing in its Approval listing, or the full sprinkler spacing, whichever is greater. For design purposes, treat pre-action systems with this detector spacing the same as wet systems. If a pre-action system has a detector spacing greater than the above spacing, consider it a dry system for design purposes. Refer to the *Approval Guide* for maximum allowable spacing.

B. Install pilot sprinklers on the same spacing as the sprinklers. For design purposes, treat pre-action sprinkler systems that use pilot sprinklers the same as dry systems, regardless of detector spacing.

2.4.1.7 Supplement automatic sprinkler protection with one of the following FM Approved fixed special protection systems to limit fire damage in an ignitable liquid storage occupancy, or as an alternative to providing an emergency drainage system:

- A. Foam-water sprinkler system
- B. Compressed air foam (CAF) system

2.4.1.7.1 Design the special protection systems in accordance with this data sheet, other applicable data sheets, and all of the defined system limitations provided in the *Approval Guide*.

2.4.1.7.2 Do not use water mist or gaseous systems in storage occupancies because they have not been shown to be effective against the potential fire scenarios in this type of occupancy.

2.4.1.8 Design and install open-sprinkler (deluge) or closed-sprinkler foam-water sprinkler systems (see Appendix A for definitions) in accordance with the following criteria:

- A. Provide an open-sprinkler or closed-sprinkler foam-water sprinkler system when required for a specific storage arrangement or to limit the exposure created by an ignitable liquid fire to surrounding areas when adequate drainage capacity is not available (see Tables 2.2.2.1.A and 2.2.2.1.B).
- B. Hydraulically design the system in accordance with a specific foam-water protection table in this data sheet, or to the full water-based sprinkler protection criteria for the storage arrangement, as applicable. In either case, the provided discharge density must be greater than or equal to the required FM Approval density for the foam-sprinkler combination.
- C. When a foam-water sprinkler system is used, provide a 20-minute supply of foam concentrate. Base the concentrate supply on the actual sprinkler system discharge (i.e., flow available from the available water supply, not the theoretical design).
- D. Provide containment as recommended in this data sheet.
- E. Use a compatible foam concentrate for the ignitable liquid being protected. Use FM Approved foam-water sprinkler system components (concentrate, proportioning equipment, tanks, control panels, and sprinklers).
- F. Install and maintain the foam-water sprinkler system in accordance with Data Sheet 4-12, *Foam-Water Sprinkler Systems* and Data Sheet 2-81, *Fire Protection System Inspection, Testing and Maintenance*.

2.4.1.9 Design and install compressed air foam (CAF) systems in accordance with the following criteria:

- A. Install the system in accordance with the manufacturer's recommendations and its listing in the *Approval Guide*. Use a compatible foam concentrate for the ignitable liquid being protected. Install the system in accordance with the manufacturer's recommendations and its listing in the *Approval Guide*. Use a compatible foam concentrate for the ignitable liquid being protected.
- B. Provide an FM Approved fire detection system that is compatible with the CAF system. Provide quick response heat detectors ($RTI \leq 90 \text{ ft/s}^{1/2}$ [$50 \text{ m/s}^{1/2}$]), spaced to provide a response time equivalent to, or earlier than, the installed ceiling sprinklers. If the detection response time cannot be calculated, install the detectors at the same spacing as the ceiling sprinklers.
- C. Hydraulically design the sprinkler system in accordance with the appropriate table in this data sheet.
- D. Hydraulically design the CAF system in accordance with the manufacturer's recommendations and its listing in the *Approval Guide*.
- E. Design the foam concentrate supply and system air supply to provide 20 minutes of foam discharge.
- F. Provide exterior hose stream demand and water supply duration as recommended in this data sheet.
- G. Provide containment as recommended in this data sheet.
- H. Ensure systems are fully acceptance tested when installed. Provide regular maintenance and testing for the system in accordance with Data Sheet 4-12.

2.4.1.10 When water-spray systems are used to provide exposure protection:

- A. Arrange spray nozzles to ensure complete coverage of the exposed wall.

- B. Provide additional nozzles specifically arranged to protect windows.
- C. Activate the water-spray system using automatic fire detectors, located to ensure prompt activation of the water-spray system.
- D. Follow guidance in Data Sheet 2-0, *Installation Guidelines for Automatic Sprinklers*; Data Sheet 4-0, *Special Protection Systems*; and Data Sheet 4-1N, *Fixed Water Spray Systems for Fire Protection*.

2.4.1.11 Provide the following hose stream and water supply duration unless the protection scheme/section specifies otherwise:

- A. Provide a 500 gpm (1900 L/min) hose stream allowance for all cutoff rooms or buildings greater than 2000 ft² (186 m²). Provide a 250 gpm (950 L/min) hose stream allowance for cutoff rooms or buildings less than or equal to 2000 ft² (186 m²).
- B. Provide a water supply that can deliver the total sprinkler and hose stream demand for a duration of at least one hour.

2.4.2 Metal Containers (Including IBCs) Larger than 60 gal (230 L)

2.4.2.1 Protect palletized or solid pile storage of relieving-style metal containers (including metallic IBCs) and FM Approved composite IBCs in accordance with Table 2.4.2.1.

2.4.2.2 Protect rack storage of relieving-style metal containers (including metallic IBCs) and FM Approved composite IBCs in accordance with Table 2.4.2.2.

Table 2.4.2.1 Palletized or Solid-Pile Storage of Ignitable Liquids in Relieving-Style Metal Containers Larger than 60 gal (230 L) and FM Approved Composite IBCs (Note 1)

Container Type	Liquid Type/ Flash Point	Maximum Ceiling Heightft (m)	Maximum Storage Height (No. of IBCs)	Ceiling Sprinkler Protection			
				Response / Nominal Temperature Rating / Orientation	K-factor gpm/psi ^{1/2} (L/min/bar ^{1/2})	Design, # Sprinklers @ Pressure psi (bar)	
Metal	<200°F (93°C)	30 (9.1)	1 high	SR/High/Any	≥11.2 (161) (Note 2, 3)	50 @ 7 (0.5)	
Metal Or FM Approved Composite IBC	≥200°F (93°C)	30 (9.1)	2 high	SR/Ordinary/Any	11.2 (161) (Note 2)	50 @ 29 (2.0)	
					14.0 (202)	30 @ 51 (3.5)	
					16.8 (235)	50 @ 18 (1.2)	
					30 @ 33 (2.3)	30 @ 23 (1.6)	
					25.2 (363)	50 @ 7 (0.5)	
			30 @ 10 (0.7)	QR/Ordinary/Any	25.2EC (363EC)	26 @ 22 (1.5)	
			15 @ 39 (2.7)	1 high	SR/Ordinary/Any	≥11.2 (161) (Note 2, 3)	50 @ 7 (0.5)
			11.2 (161) (Note 2)			30 @ 29 (2.0)	
			14.0 (202)			30 @ 18 (1.2)	
			16.8 (235)			30 @ 13 (0.9)	
25.2 (363)	30 @ 7 (0.5)						
QR/Ordinary/Any	25.2EC (363EC)	15 @ 22 (1.5)					
Any	Very high flash point liquid			See Section 2.1.3.1			

Notes:

1. See Section D.1 for explanation of abbreviations.
2. If a foam-water sprinkler system is used, use of K 8.0 (K115) ceiling sprinklers is acceptable as long as an equivalent flow is provided from the K8.0 (K115) sprinkler.
3. The K19.6 (K280) sprinkler is not acceptable for use in this protection table.

Table 2.4.2.2. Rack Storage of Ignitable Liquids in Relieving-Style Metal Containers Larger than 60 gal (230 L) and FM Approved Composite IBCs (Note 1)

Container type	Flash Point OR Liquid Type	Maximum Ceiling Height ft (m)	Maximum Storage Height (No. of IBCs)	Ceiling Sprinkler Protection			In-Rack Sprinkler Protection			
				Response/ Nominal Temperature Rating/ Orientation	K-factor gpm/psi ^{1/2} (L/min/bar ^{1/2})	Design, # Sprinklers @ Pressure psi (bar)	Layout (see figure indicated)	Response/ Nominal Temperature Rating	K-factor gpm/psi ^{1/2} (L/min/bar ^{1/2})	Design, # Sprinklers @ Flow gpm (L/min) (see 2.4.1.5)
Metal	Any	30 (9.1)	3 high	SR/High/Any	≥11.2 (161) (Note 2, 3)	50 @ 7 (0.5)	Fig. D.2.1.1, D.2.1.2, D.2.1.3	QR/Ordinary	≥8.0 (115)	12 @ 45 (170) (6 per tier per rack)
FM Approved Composite IBC	≥200°F (93°C)	30 (9.1)	3 high	SR/High/Any	≥11.2 (161) (Note 2, 3)	50 @ 7 (0.5)	Fig. D.2.1.1, D.2.1.2, D.2.1.3	QR/Ordinary	≥8.0 (115)	12 @ 45 (170) (6 per tier per rack)
Any	Very high flash point liquid	See Section 2.1.3.1								

Notes:

1. See Section D.1 for explanation of abbreviations.
2. If a foam-water sprinkler system is used, use of K 8.0 (K115) ceiling sprinklers is acceptable as long as an equivalent flow is provided from the K8.0 (K115) sprinkler.
3. The K19.6 (K280) sprinkler is not acceptable for use in this protection table.

2.4.3 Metal Containers Larger than 6.5 gal (25 L) Up to and Including 60 gal (230 L)

2.4.3.1 Protect rack storage in accordance with Table 2.4.3.1.

2.4.3.1.1 To protect rack storage greater than the listed 30 ft (9.1 m) roof heights. All packaging for the container must be noncombustible. Wooded pallets are acceptable:

- A. Continue the in-rack protection layout recommended for 25 ft (7.6 m) high storage over each additional tier of storage.
- B. For water-only protection, add a line of face sprinklers above the second tier regardless of roof design.
- C. For each additional tier of storage, add three (3) in-rack sprinklers to the in-rack hydraulic design.

2.4.3.2 Protect palletized or solid-pile storage in accordance with Table 2.4.3.2. Apply the following limitations to the protection schemes provided in this table:

- A. Limit the storage height of liquids with a boiling point below 100°F (38°C) to one container high.
- B. Where a relieving-style container is required:
 1. Provide FM Approved fusible closures on the 2 in. (50.8 mm) and 3/4 in. (19 mm) openings in the top of the steel drum.
 2. Use fusible closures on steel drums that do not exceed 60 gal (227 L) in size, and have thread dimensions in accordance with ISO 228-1:2000 or ASME B1.20.1-2013 (R2018). Regardless of which thread standard is used, the threads must also be within the defined tolerance of the other standard.
 3. Use fusible closures with drums that are either a tight head (DOT/UN specification 1A1) or removable head (DOT/UN specification 1A2) design.
 - Tight head drums must be capable of resisting an internal pressure of 20 psig (1.4 barg) when fully engulfed in an ignitable liquid pool fire (i.e., all cylindrical surfaces exposed to a consistent flame that extends above the top of the drum) without rupture or leakage of the drum.
 4. Use steel drums that have at least a 1 mm wall/top/bottom thickness as relieving-style drums.
 5. Do not use fusible closures for dispensing as they are not equivalent to safety bungs. Use fusible closures on drums that are in transit or in storage.
 6. Do not use metallic cap seals over the fusible closure. Thin thermoplastic cap seals are acceptable. Do not paint fusible closures.
 7. Purchase the material with the fusible closures installed on the drum before they are delivered.
 8. Develop and implement a management control system to ensure the proper fusible closures are provided in accordance with Recommendation 2.7.5.
 9. Palletize relieving-style containers on open deck (i.e., slatted) pallets and store on-end. Do not solid pile the drums.
- C. Design and install foam-water sprinkler systems in accordance with Recommendation 2.4.1.8 of this data sheet.
- D. Design foam-water sprinkler systems to deliver foam discharge out of the most remote 4 operating sprinklers within 2 minutes of sprinkler operation. Pre-prime (i.e., pre-fill the sprinkler piping with the correct foam-water mixture) foam-water sprinkler systems that cannot meet the 2-minute delivery time.

Table 2.4.3.1 Rack Storage of Ignitable Liquids in Metal Containers larger than 6.5 gal (25 L) Up to and Including 60 gal (230 L) (Note 1)

Flash Point OR Liquid Type (Note 3)	Maximum Ceiling Height ft(m)	Maximum Storage Height ft(m)	Drum Orientation	Minimum aisle width ft (m)	Ceiling Sprinkler Protection				In-Rack Sprinkler Protection														
					Protection Type	Response / Nominal Temperature Rating / Orientation	K-factor gpm/psi ^{1/2} (L/min/bar ^{1/2})	Design, # Sprinklers @ Pressure psi (bar)	Layout (see figure indicated)	Response/ Nominal Temperature Rating	K-factor gpm/psi ^{1/2} (L/min/bar ^{1/2})	Design, # Sprinklers @ Flowgpm (l/min) (see 2.4.1.5)											
Any	Any	Any	Any	8 (2.4)	See 2.4.3.1.1 (all packaging must be noncombustible)																		
Any	30 (9.1)	25 (7.6)	On-End	8 (2.4)	Foam-water	SR/High/Any	≥11.2 (161) (Note 2, 3)	30 @ 7 (0.5)	Fig. D.2.1.4, D.2.1.6, D.2.1.7 and D.2.1.8	QR/Ordinary	≥8.0 (115)	18 @ 45 (170) (6 per tier per rack)											
<200°F (93°C))	30 (9.1)	25 (7.6)	On-End	8 (2.4)	Water	SR/High/Any	≥11.2 (161) (Note 2, 3)	50 @ 7 (0.5)	Fig. D.2.1.4, D.2.1.5, D.2.1.7 and D.2.1.8	QR/Ordinary	≥8.0 (115)	18 @ 45 (170) (6 per tier per rack)											
								SR/High/Any					11.2 (161) (Note 2)	50 @ 29 (2.0)	Fig. D.2.1.4, D.2.1.6, D.2.1.7 and D.2.1.8	QR/Ordinary	≥8.0 (115)	18 @ 45 (170) (6 per tier per rack)					
													14.0 (202)	50 @ 18 (1.2)									
													16.8 (235)	50 @ 13 (0.9)									
													2.2 (363)	50 @ 7 (0.5)									
			On-Side	8 (2.4)	Water	SR/High/Any	≥11.2 (161) (Note 2, 3)	50 @ 7 (0.5)	Fig. D.2.1.9, D.2.1.10	QR/Ordinary	≥8.0 (115)	18 @ 35 (133) (6 per tier per rack)											
													Water	SR/High/Any	11.2 (161) (Note 2)	50 @ 29 (2.0)	Fig. D.2.1.11, D.2.1.12	QR/Ordinary	≥8.0 (115)	18 @ 35 (133) (6 per tier per rack)			
																						14.0 (202)	50 @ 18 (1.2)
																						16.8 (235)	50 @ 13 (0.9)
																						25.2 (363)	50 @ 7 (0.5)

Table 2.4.3.1 Rack Storage of Ignitable Liquids in Metal Containers larger than 6.5 gal (25 L) Up to and Including 60 gal (230 L) (Note 1) (continued)

Flash Point OR Liquid Type (Note 3)	Maximum Ceiling Height ft(m)	Maximum Storage Height ft(m)	Drum Orientation	Minimum aisle width ft (m)	Ceiling Sprinkler Protection				In-Rack Sprinkler Protection			
					Protection Type	Response / Nominal Temperature Rating / Orientation	K-factor gpm/psi ^{1/2} (L/min/bar ^{1/2})	Design, # Sprinklers @ Pressure psi (bar)	Layout (see figure indicated)	Response/ Nominal Temperature Rating	K-factor gpm/psi ^{1/2} (L/min/bar ^{1/2})	Design, # Sprinklers @ Flowgpm (l/min) (see 2.4.1.5)
Water-miscible liquids	30 (9.1)	25 (7.6)	On-End	8 (2.4)	Water	SR/High/Any	Fig. D.2.1.4, D.2.1.6, D.2.1.7 and D.2.1.8	QR/Ordinary	≥5.6 (81)	6 @ 25 (95) (one level of in racks), or 12 @ 15 (57) or 12 @ 18 (68) (more than one level of in racks. See 2.4.1.5)	≥11.2 (161) (Note, 2, 3)	50 @ 7 (0.5)
					Water	SR/High/Any	Fig. D.2.1.9, D.2.1.10	QR/Ordinary	≥5.6 (81)	6 @ 25 (95) (one level of in racks), or 12 @ 15 (57) or 12 @ 18 (68) (more than one level of in racks. See 2.4.1.5)	≥11.2 (161) (Note, 2, 3)	50 @ 7 (0.5)
			On-Side	8 (2.4)	Water	SR/High/Any1	11.2 (161) (Note 2) 14.0 (202) 16.8 (235) 25.2 (363)	50 @ 29 (2.0) 50 @ 18 (1.2) 50 @ 13 (0.9) 50 @ 7 (0.5)	Fig. D.2.1.11, D.2.1.12	QR/Ordinary	≥5.6 (81)	6 @ 25 (95) (one level of in racks), or 12 @ 15 (57) or 12 @ 18 (68) (more than one level of in racks. See 2.4.1.5)
≥200°F (93°C)	30 (9.1)	25 (7.6)	On-End	8 (2.4)	Water	SR/High/Any	≥11.2 (161) (Note 2, 3)	50 @ 7 (0.5)	Fig. D.2.1.13, D.2.1.14, D.2.1.7 and D.2.1.8	QR/Ordinary	≥5.6 (81)	6 @ 25 (95) (one level of in racks), or 12 @ 15 (57) or 12 @ 18 (68) (more than one level of in racks. See 2.4.1.5)
					On-Side	8 (2.4)	Water	SR/High/Any	≥11.2 (161) (Note 2, 3)	50 @ 7 (0.5)	Fig. D.2.1.15, D.2.1.16	QR/Ordinary
Very high flash point liquid	See Section 2.1.3.1											

Notes:

1. See Section D.1 for explanation of abbreviations.
2. If a foam-water sprinkler system is used, use of K 8.0 (K115) ceiling sprinklers is acceptable as long as an equivalent flow is provided from the K8.0 (K115) sprinkler.
3. The K19.6 (K280) sprinkler is not acceptable for use in this protection table.

Table 2.4.3.2. Palletized/Solid-Pile Storage of Ignitable Liquids in metal Containers Larger than 6.5 gal (25 L) Up to and Including 60 gal (230 L)
(Apply Table in Accordance with Recommendation 2.4.3.2) (Note 1)

Liquid Type, Flash Point	Maximum Ceiling Height ft (m)	Drum Orientation	Maximum Height (No. Drums)	Relieving-style Drum Required (Yes/No)	Ceiling Sprinkler Protection			
					Protection Type	Response / Nominal Temperature Rating / Orientation	K-factor gpm/psi ^{1/2} (L/min/bar ^{1/2})	Design, # Sprinklers @ Pressure psi (bar)
Any	30 (9.1)	On-End	1	No	Water	SR/High/Any	>11.2 (161) (Note 4)	50 @ 7 (0.5)
					Foam-Water	SR/High/Any	≥11.2 (161)(Note 4)	30 @ 7 (0.5)
			2	Yes	Water	SR/High/Any	11.2 (161)	50 @ 29 (2.0)
							14.0 (202)	50 @ 18 (1.2)
							16.8 (235)	50 @ 13 (0.9)
							25.2 (363)	50 @ 7 (0.5)
			3 (Note 3)	Yes	Foam-Water	SR/High/Any	≥11.2 (161)(Note 4)	30 @ 7 (0.5)
							11.2 (161)	30 @ 16 (1.1)
			4	Yes	Foam-Water	SR/High/Any	14.0 (202)	30 @ 10 (0.7)
							≥16.8 (235) (Note 4)	30 @ 7 (0.5)
		11.2 (161)					30 @ 29 (2.0)	
		14.0 (202)					30 @ 18 (1.2)	
		On-Side	1	No (Note 2)	Water	SR/High/Any	≥11.2 (161)(Note 4)	50 @ 7 (0.5)
							11.2 (161)	50 @ 29 (2.0)
			3	No (Note 2)	Water	SR/High/Any	14.0 (202)	50 @ 18 (1.2)
							16.8 (235)	50 @ 13 (0.9)
							25.2 (363)	50 @ 7 (0.5)
							11.2 (161)	50 @ 7 (0.5)

Table 2.4.3.2. Palletized/Solid-Pile Storage of Ignitable Liquids in metal Containers Larger than 6.5 gal (25 L) Up to and Including 60 gal (230 L)
(Apply Table in Accordance with Recommendation 2.4.3.2) (Note 1) (continued)

Liquid Type, Flash Point	Maximum Ceiling Heightft (m)	Drum Orientation	Maximum Height/(No. Drums)	Relieving-style Drum Required(Yes/No)	Ceiling Sprinkler Protection			
					Protection Type	Response / Nominal Temperature Rating / Orientation	K-factor gpm/psi ^{1/2} (L/min/bar ^{1/2})	Design, # Sprinklers @ Pressure psi (bar)
≥200°F (93°C) (Note 2)	30 (9.1)	On-End	4	Yes	Water	SR/High/Any	11.2 (161)	50 @ 29 (2.0)
							14.0 (202)	50 @ 18 (1.2)
							16.8 (235)	50 @ 13 (0.9)
							25.2 (363)	50 @ 7 (0.5)
	On-Side	6	No (Note 2)	Water	SR/High/Any	11.2 (161)	50 @ 29 (2.0)	
						14.0 (202)	50 @ 18 (1.2)	
						16.8 (235)	50 @ 13 (0.9)	
						25.2 (363)	50 @ 7 (0.5)	
Very high flash point liquid	See Section 2.1.3.1							

- Notes:
1. See Section D.1 for explanation of abbreviations.
 2. Never use a relieving-style drum when drums are stored on side, on solid top pallets, or on plastic pallets that melt when heated. On-side storage arrangement will allow relieving-style drums to empty if the fusible closure opens. Solid top pallets will prevent the fusible closure from functioning. Plastic pallets will allow the array to collapse and release ignitable liquids.
 3. Unsaturated polyester resin (UPR) mixtures with 50% or less styrene can be protected palletized to 3 relieving-style drums high without a foam-water sprinkler system.
 4. The K19.6 (K280) sprinkler is not acceptable for use in this protection table.

2.4.4 Metal Containers of 6.5 gal (25 L) or Less

2.4.4.1 Protect rack storage in accordance with Table 2.4.4.1.A or 2.4.4.1.B. Table 2.4.4.1.B can only be applied to the storage of relieving-style metal containers (see Appendix A for definition) and ignitable liquids with a boiling point above 100°F (38°C).

2.4.4.1.1 To protect rack storage of only uncartoned containers greater than the listed 30 ft (9.1 m) roof heights, continue the in-rack protection layout recommended for 25 ft (7.6 m) high storage (Figures D.2.1.17, D.2.1.18, D.2.1.20 and D.2.1.21) over each additional tier of storage. For each additional tier of storage, add three (3) in-rack sprinklers to the in-rack hydraulic design.

2.4.4.2 Protect palletized or solid-pile storage in accordance with Table 2.4.4.1.B or 2.4.4.2.

2.4.4.2.1 Table 2.4.4.1.B can only be applied to the storage of relieving-style metal containers (see Appendix A for definition) and ignitable liquids with a boiling point above 100°F (38°C).

2.4.4.2.2 Table 2.4.4.2 can be applied to the storage of very high flashpoint liquids in non-relieving style containers as long as they are not exposed to the storage of lower flash point liquids.

2.4.4.3 Protect shelf storage in accordance with Table 2.4.4.3.

- A. Limit shelves to no more than a 2 ft (0.6 m) deep (dimension from aisle face to back of shelf) and noncombustible construction.
- B. Separate back-to-back shelves with a noncombustible partition.
- C. Treat shelves lacking this partition like a single-row rack.

Table 2.4.4.1.A. Rack Storage of Ignitable Liquid in Metal Containers Up to and Including 6.5 gal (25 L) (Note 1)

Liquid Type, Flash Point	Maximum Ceiling Height ft (m)	Maximum Storage Height ft (m)	Packaging Type	Minimum Aisle Width ft (m)	Ceiling Sprinkler Protection			In-Rack Sprinkler Protection			Design, Flow gpm (l/min) (see 2.4.1.5) (Note 2)
					Response/Nominal Temperature Rating/Orientation	K-factor gpm/psi ^{1/2} (L/min/bar ^{1/2})	Design, # Sprinklers @ Pressurepsi (bar)	Layout (see figure indicated)	Response/Nominal Temperature Rating	K-factor gpm/psi ^{1/2} (L/min/bar ^{1/2})	
Any	Any	Any	Uncartoned and/or Cartoned	4 (1.2)	Any	Any	Minimum 0.2 gpm/ft ² (8 mm/min)	Scheme A			
Any	Any	Any	Uncartoned	8 (2.4)	See 2.4.4.1.1						
Any	30 (9.1)	25 (7.6)	Uncartoned and/or Cartoned	8 (2.4)	SR/Ordinary /Any	≥11.2 (161) (Note 3, 4)	20 @ 7 (0.5)	Figs. D.2.1.17, D.2.1.18, D.2.1.20 and D.2.1.21	QR/Ordinary	≥8.0 (115)	45 (170)
					QR/Ordinary /Any	25.2EC (363EC)	11 @ 7 (0.5)				
			Cartoned Only	8 (2.4)	SR/Ordinary /Any	≥11.2 (161) (Note 3, 4)	50 @ 7 (0.5)	Figs. D.2.1.17, D.2.1.18, D.2.1.19, D.2.1.20 and D.2.1.21	QR/Ordinary	≥8.0 (115)	45 (170)
					QR/Ordinary /Any	25.2EC (363EC)	26 @ 7 (0.5)				
Water-miscible	30 (9.1)	25 (7.6)	Uncartoned and/or Cartoned	8 (2.4)	SR/Ordinary /Any	≥11.2 (161) (Note 3, 4)	20 @ 7 (0.5)	Figs. D.2.1.22, D.2.1.23, D.2.1.24 and D.2.1.25	QR/Ordinary	≥8.0 (115)	30 (114)
					QR/Ordinary /Any	25.2EC (363EC)	11 @ 7 (0.5)				

Notes:

1. See Section D.1 for explanation of abbreviations.
2. Base the in-rack sprinkler water demand on the simultaneous operation of the most hydraulically remote sprinklers as follows:
 - a. Eight (8) sprinklers where only one level of in-rack sprinklers is installed
 - b. Twelve (12) sprinklers (six on each two top levels) where two levels of in-rack sprinklers are installed
 - c. Eighteen (18) sprinklers (six on top three levels) where more than two levels of in-rack sprinklers are installed
 - d. The in-rack end head pressure as provided in this Table.
3. If a foam-water sprinkler system is used, use of K 8.0 (K115) ceiling sprinklers is acceptable as long as an equivalent flow is provided from the K8.0 (K115) sprinkler.
4. The K19.6 (K280) sprinkler is not acceptable for use.

Table 2.4.4.1.B. Protection for Any Ignitable Liquid in Relieving-Style Metal Containers Up to and Including 6.5 gal (25 L), Excluding Ignitable Liquids with a Boiling Point Below 100°F (38°C) (Note 1)

Storage Arrangement	Minimum Aisle Width ft (m)	Maximum Ceiling Height ft (m)	Maximum Storage Height ft (m)	Packaging Type	Ceiling Sprinkler Protection			In-Rack Sprinkler Protection			
					Response/Nominal Temperature Rating/Sprinkler Orientation	K-factor gpm/psi ^{1/2} (L/min/bar ^{1/2})	Design, # of Sprinklers @ Pressure psi (bar)	Layout (see figure indicated)	Response / Nominal Temperature Rating	K-factor gpm/psi ^{1/2} (L/min/bar ^{1/2})	Design Flow gpm (l/min) (see 2.4.1.5) (Note 2)
Single & Double Row Racks	8 (2.4)	33 (10)	25 (7.6)	Uncartoned and/or Cartoned	QR/Ordinary/Pendent	14.0 (202)	12 @ 75 (5.2)	Figs. D.2.1.26, D.2.1.27, D.2.1.28, D.2.1.29	QR/Ordinary	≥8.0 (115)	45 (170)
						16.8 (235)	12 @ 52 (3.6)				
						22.4 (320)	12 @ 51 (3.5)				
						25.2 (363)	12 @ 40 (2.8)				
				Cartoned Only	QR/Ordinary/Pendent	14.0 (202)	12 @ 50 (3.4)	Figs. D.2.1.30, D.2.1.31, D.2.1.32, D.2.1.33	QR/Ordinary	≥8.0 (115)	30 (114)
						16.8 (235)	12 @ 35 (2.4)				
						22.4 (320)	12 @ 25 (1.7)				
						25.2 (363)	12 @ 20 (1.4)				
		30 (9.1)	20 (6)	Cartoned Only	QR/Ordinary/Pendent	14.0 (202)	12 @ 75 (5.2)	None			
						16.8 (235)	12 @ 52 (3.6)				
						22.4 (320)	12 @ 51 (3.5)				
						25.2 (363)	12 @ 40 (2.8)				
Multiple Row Racks	None	33 (10)	25 (7.6)	Uncartoned and/or Cartoned	QR/Ordinary/Pendent	14.0 (202)	12 @ 75 (5.2)	Figs. D.2.1.34 and D.2.1.35 or D.2.1.36 and D.2.1.37	QR/Ordinary	≥8.0 (115)	45 (170)
						16.8 (235)	12 @ 52 (3.6)				
						22.4 (320)	12 @ 51 (3.5)				
						25.2 (363)	12 @ 40 (2.8)				
				Cartoned Only	QR/Ordinary/Pendent	14.0 (202)	12 @ 50 (3.4)	Figs. D.2.1.38 and D.2.1.39 or D.2.1.40 and D.2.1.41	QR/Ordinary	≥8.0 (115)	45 (170)
						16.8 (235)	12 @ 35 (2.4)				
						22.4 (320)	12 @ 25 (1.7)				
						25.2 (363)	12 @ 20 (1.4)				
Palletized	DNA	33 (10)	12 (3.7)	Uncartoned and/or Cartoned	QR/Ordinary/Pendent	14.0 (202)	12 @ 75 (5.2)	None			
						16.8 (235)	12 @ 52 (3.6)				
						22.4 (320)	12 @ 51 (3.5)				
						25.2 (363)	12 @ 40 (2.8)				
			8 (2.4)	Cartoned Only	QR/Ordinary/Pendent	14.0 (202)	12 @ 50 (3.4)	None			
						16.8 (235)	12 @ 35 (2.4)				
						22.4 (320)	12 @ 25 (1.7)				
						25.2 (363)	12 @ 20 (1.4)				

Notes: 1. See Section D.1 for explanation of abbreviations.
 2. Base the in-rack sprinkler water demand on the simultaneous operation of the most hydraulically remote sprinklers as follows: a. Eight (8) sprinklers where only one level of in-rack sprinklers is installed; b. Twelve (12) sprinklers (six on each two top levels) where two levels of in-rack sprinklers are installed; c. Eighteen (18) sprinklers (six on top three levels) where more than two levels of in-rack sprinklers are installed

Table 2.4.4.2. Palletized/Solid-Pile Storage of Liquids In Non Relieving-Style Metal Containers Up to and Including 6.5 gal (25 L) (Note 1)

Liquid Type, Flash Point	Maximum Ceiling Height ft (m)	Maximum Storage Height ft (m)	Packaging Type	Ceiling Sprinkler Protection		
				Response/Nominal Temperature Rating/ Orientation	K-factor gpm/psi ^{1/2} (L/min/ bar ^{1/2})	Design, # of Sprinklers @ Pressure psi (bar)
Any	30 (9.1)	5 (1.5)	Uncartoned and/or Cartoned	QR/Ordinary/Any	14.0 (202)	50 @ 18 (1.2)
					16.8 (235)	50 @ 13 (0.9)
					≥22.4 (320)	50 @ 7 (0.5)
		12 (3.7)	Cartoned Only	SR/Ordinary/Any	11.2 (161) (Note 2)	50 @ 29 (2.0)
					14.0 (202)	50 @ 18 (1.2)
					16.8 (235)	50 @ 13 (0.9)
					25.2 (360)	50 @ 7 (0.5)
QR/Ordinary/Any	25.2EC (360EC)	26 @ 22 (1.5)				

Notes:

- See Section D.1 for explanation of abbreviations.
- If a foam-water sprinkler system is used, use of K 8.0 (K115) ceiling sprinklers is acceptable as long as an equivalent flow is provided from the K8.0 (K115) sprinkler.

Table 2.4.4.3. Shelf Storage of Liquids in Metal Containers Up to and Including 6.5 gal (25 L) (Note 1)

Liquid Type, Flash Point	Maximum Ceiling Height ft (m)	Maximum Storage Height ft (m)	Ceiling Sprinkler Protection		
			Response / Nominal Temperature Rating / Orientation	K-factor gpm/psi ^{1/2} (L/min/bar ^{1/2})	Design, # of Sprinklers @ Pressure psi (bar)
<200°F (93°C)	30 (9.1)	7 (2.1)	SR/Ordinary/Any	≥11.2 (161) (Note 2, 3)	50 @ 7 (0.5)
			QR/Ordinary/Any	25.2EC (363EC)	26 @ 7 (0.5)
			SR/High/Any	≥11.2 (161) (Note 2, 3)	30 @ 7 (0.5)
≥200°F (93°C) or water-miscible	30 (9.1)	15 (4.6)	SR/Ordinary/Any	≥11.2 (161) (Note 2, 3)	30 @ 7 (0.5)
			QR/Ordinary/Any	25.2EC (363EC)	15 @ 7 (0.5)

Notes:

- See Section D.1 for explanation of abbreviations.
- If a foam-water sprinkler system is used, use of K 8.0 (K115) ceiling sprinklers is acceptable as long as an equivalent flow is provided from the K8.0 (K115) sprinkler.
- The K19.6 (K280) sprinkler is not acceptable for use in this protection table.

2.4.5 Protection of Plastic, Composite (Plastic-Metal), or Other Combustible Containers: General

2.4.5.1 Protect storage of all ignitable liquids in plastic, composite (plastic-metal), glass, or other combustible packing in accordance with Table 2.4.5.1.

2.4.5.2 Protect ignitable liquids in plastic or glass containers stored in shelves using the criteria in Table 2.4.5.1.

2.4.5.3 Protect storage of empty composite IBCs in accordance with Data Sheet 8-1, *Commodity Classification*.

Table 2.4.5.1. Fire Protection Criteria for Ignitable Liquids in Plastic or Glass Containers (Note 1)

Liquid Type, Flash Point	Container Size(gal (L))	Storage Arrangement	Maximum Ceiling Heightft (m)	Maximum Storage Heightft (m)	Ceiling Sprinkler System Type	Ceiling Sprinkler Protection								
						Response / Nominal Temperature Rating / Orientation	K-factor gpm/ psi ^{1/2} (L/min/bar ^{1/2}) (Note 2)	Design, # of Sprinklers @ Pressure psi (bar)						
<200°F(93°C)	>1 (4)	Palletized/ Shelf	30 (9.1)	5 (1.5)	Any	SR or QR/Ordinary/Any	11.2 (161)	Entire Room @ 75 (5.2)						
							14.0 (202)	Entire Room @ 48 (3.3)						
							16.8 (235)	Entire Room @ 33 (2.3)						
							22.4 (320)	Entire Room @ 19 (1.3)						
							25.2 (363)	Entire Room @ 15 (1.0)						
							11.2 (161)	Entire Room @ 50 (3.5)						
							14.0 (202)	Entire Room @ 32 (2.2)						
					Deluge or Foam-Water	SR or QR/Ordinary/Any	16.8 (235)	Entire Room @ 22 (1.5)						
							22.4 (320)	Entire Room @ 12 (0.8)						
							25.2 (363)	Entire Room @ 10 (0.7)						
							Rack Storage			No options; use criteria for palletized storage.				
							≤1 (4)	Palletized/ Shelf	30 (9.1)	5 (1.5)	Any	SR or QR/Ordinary/Any	11.2 (161)	Entire Room @ 75 (5.2)
													14.0 (202)	Entire Room @ 48 (3.3)
													16.8 (235)	Entire Room @ 33 (2.3)
22.4 (320)	Entire Room @ 19 (1.3)													
Deluge or Foam-Water	SR or QR/Ordinary/Any	25.2 (363)	Entire Room @ 15 (1.0)											
		11.2 (161)	Entire Room @ 50 (3.5)											
		14.0 (202)	Entire Room @ 32 (2.2)											
16.8 (235)	Entire Room @ 22 (1.5)													
22.4 (320)	Entire Room @ 12 (0.8)													
25.2 (363)	Entire Room @ 10 (0.7)													
Rack Storage			Use Section 2.4.7.1 and Table 2.4.7.1. If liquid-package combination is not covered by Table 2.4.7.1, use criteria for palletized storage above.											
Water-miscible liquids	>6.5 (25)	Palletized/ Shelf	30 (9.1)	5 (1.5)	Any	SR or QR/Ordinary/Any	11.2 (161)	Entire Room @ 30 (2.0)						
							14.0 (202)	Entire Room @ 19 (1.3)						
							16.8 (235)	Entire Room @ 13 (0.9)						
							≥22.4 (320)	Entire Room @ 7 (0.5)						
							Rack Storage			Use Section 2.4.6 and Table 2.4.6.1, or Section 2.4.7.3 and Table 2.4.7.3.1, for Group 1, 2, 3, and 4 water-miscible liquids (defined in Section 3.2.1). If liquid-package combination is not covered by Table 2.4.6.1, use criteria for palletized storage above.				
							≤6.5 (25)			Use Section 2.4.7.3 and Tables 2.4.7.3.1 and 2.4.7.3.2 for Group 1, 2, 3, and 4 water-miscible liquids (defined in Section 3.1.1). Protect water-miscible liquids that are not included in one of the groups or Tables 2.4.7.3.1 and 2.4.7.3.2 using the criteria provided for water-miscible liquids in containers >6.5 gal (25 L) in this table.				
Distilled Spirits in wooden barrels use Section 2.4.8 or 2.4.9. If liquid-container combination is not covered by this section, protect per this table.														
Propylene glycol or ethylene glycol	≥60 (230) and ≤300 (1100)	Palletized	See Tables 2.4.6.1 (IBCs) or 2.4.7.3.2 (Drums)											
≥200°F(93°C)	>6.5 (25)	Palletized/ Shelf	30 (9.1)	5 (1.5)	Any	SR or QR/Ordinary/Any	11.2 (161)	Entire Room @ 30 (2.0)						
							14.0 (202)	Entire Room @ 19 (1.3)						
							16.8 (235)	Entire Room @ 13 (0.9)						
							≥ 22.4 (320)	Entire Room @ 7 (0.5)						
							Rack Storage			Use Section 2.4.6 and Table 2.4.6.1. If liquid-package combination is not covered by Table 2.4.6.1, use criteria for palletized storage above.				
≤6.5 (25)			Use Section 2.4.7.2 and Tables 2.4.7.2.1 and 2.4.7.2.2. If liquid-package combination is not covered by Tables 2.4.7.2.1 or 2.4.7.2.2, use criteria for containers >6.5 gal (25 L) in this table.											
Very high flash point liquid	See Section 2.1.3.1 to define fire protection.													

Note: 1. See Section D.1 for explanation of abbreviations.

2. The K19.6 (K280) sprinkler is not acceptable for use in this protection table.

2.4.6 Composite (blow molded bottle in a wire cage on a wood or steel pallet) IBC Storage of Liquids with a Flash Point At or Above 200°F (93°C) or Alcohol in Racks or Palletized Storage of Propylene/Ethylene Glycol

2.4.6.1 Use Table 2.4.6.1 to protect rack storage of liquids with a flash point at or above 200°F (93°C), alcohol (isopropyl alcohol, ethyl alcohol, methyl alcohol), in composite IBCs consisting of a blow molded bottle in a wire cage on a wood or steel pallet. Protect all tiers of the rack with the same level of fire protection.

A. Limit IBC storage to the first tier of the rack. Upper tiers may be used for storage of other liquid-packaging combinations that are 60 gal (230 L) or less in size and that can be protected by the provided level of protection.

B. Arrange the room to ensure all storage is kept in the racks and not staged or stored on the floor. The provided ceiling protection will not prevent failure of any IBC not stored in the racks and will only provide limited protection for large pool fires.

2.4.6.2 Use Table 2.4.6.1 to protect palletized storage of propylene/ethylene glycol in composite IBCs. Do not store palletized IBCs with other storage due to potential for a pool fire.

2.4.6.3 Protect FM Approved composite IBCs in accordance with 2.1.1.8.

Table 2.4.6.1. Storage of Liquids in Composite IBCs (blow molded bottle in a wire cage on a wood or steel pallet)
(Note 1)

Liquid Type, Flash Point	Container Size gal (L)	Storage Array	Maximum Ceiling Height ft (m)	Maximum Storage Height	Minimum Aisle Width ft (m)	Rack Type	Ceiling Sprinkler Protection			In-Rack Sprinkler Protection
							Response/ Nominal Temperature Rating/ Orientation	K-factor gpm/psi ^{1/2} (L/min/ bar ^{1/2})	Design, # of Sprinklers @ Pressure psi (bar)	
≥200°F (93°C) or Alcohol	≥60 (230) and ≤300 (1100)	Rack	30 (9.1)	1 IBC high in bottom tier of rack	8 (2.4)	Single or Double Row	SR/Ordinary/ Any	11.2 (161)	30 @ 13 (0.9) (Note 3)	Scheme D
								14.0 (202)	30 @ 8 (0.6) (Note 3)	
								≥16.8 (235) (Note 2)	30 @ 7 (0.5) (Note 3)	
							QR/Ordinary/ Any	25.2EC (363 EC)	16 @ 10 (0.7) (Note 3)	
Propylene glycol or ethylene glycol	>60 (230) and ≤300 (1100)	Palletized	30 (9.1)	1 IBC high	DNA	DNA	SR/Ordinary/ Any	≥11.2 (161) (Note 2)	20 @ 7 (0.5)	DNA
							QR/Ordinary/ Any	25.2EC (363 EC)	10 @ 7 (0.5)	DNA
				3 IBCs high	DNA	DNA	SR/Ordinary/ Any	11.2 (161)	20 @ 28 (1.9)	DNA
								14.0 (202)	20 @ 18 (1.2)	DNA
								16.8 (235)	20 @ 13 (0.9)	DNA
								≥22.4 (310)	20 @ 7 (0.5)	DNA
				DNA	DNA	QR/Ordinary/ Any	25.2EC (363 EC)	10 @ 22 (1.5)	DNA	

Notes:

- See Section D.1 for explanation of abbreviations. See Section D.2.2 for fire protection schemes.
- The K19.6 (K280) sprinkler is not acceptable for use in this protection table.
- In cutoff rooms where on-floor storage is impossible, i.e., only rack storage and transport aisles, the ceiling sprinkler operating area can be reduced to 20 sprinklers for non-EC sprinklers and 10 sprinklers for the K25.2 EC (360 EC) sprinkler.

2.4.7 Plastic, Glass, or Other Combustible/Brittle Containers Up to and Including 60 gal (230 L)

2.4.7.1 Protect storage of non-water-miscible liquids with flash points below 200°F (93°C) as follows:

- Provide sprinkler protection in accordance with Table 2.4.5.1 or 2.4.7.1, based on container size, storage arrangement, roof/ceiling height, and storage height.
- When needed, provide foam-water protection in accordance with this data sheet and Data Sheet 4-12.

Table 2.4.7.1. Rack Storage of Liquids in Plastic or Glass Containers with Flash Points Below 200°F (93°C) (Note 1)

Liquid Type, Flash Point	Container Size	Packaging Type	Maximum Ceiling Height ft (m)	Maximum Storage Height ft (m)	Minimum Aisle Width ft (m)	Rack Type	Protection Type	Ceiling Sprinkler Protection			In-Rack Sprinkler Protection
								Response/Nominal Temperature Rating/Orientation	K-factor gpm/psi ^{1/2} (L/min/bar ^{1/2})	Design, # of Sprinklers @ Pressure psi (bar)	
<200°F (93°C)	≤0.5 oz (15 ml)	Cartoned	30 (9.1)	25 (7.6)	8 (2.4)	Single or Double Row	Water	SR/Ordinary/Any	≥11.2 (161) (Note 2, 3)	20 @ 7 (0.5)	Scheme C
								QR/Ordinary/Any	25.2EC (363EC)	11 @ 7 (0.5)	
							Water	QR/Ordinary/Pendent	14.0 (202)	12 @ 50 (3.5)	None
		16.8 (235)	12 @ 35 (2.4)								
		22.4 (310)	12 @ 35 (2.4)								
		Water	QR/Ordinary/Pendent	25.2 (360)	12 @ 35 (2.4)	None					
	14.0 (202)			12 @ 75 (5.2)							
	16.8 (235)			12 @ 60 (4.1)							
	Water	QR/Ordinary/Pendent	22.4 (310)	12 @ 60 (4.1)	None						
			25.2 (360)	12 @ 60 (4.1)							
14.0 (202)			12 @ 75 (5.2)								
≤2 oz (60 ml)	Cartoned	Unlimited	Unlimited	4 (1.2)	Any	Water	Any	Any	Minimum 0.2 gpm/ft ² (8 mm/min)	Scheme A	
≤1 gal(4 L)	Cartoned	35 (10.6)	20 (6)	8 (2.4)	Single or Double Row	Foam-Water (Note 4)	SR/Ordinary/Any	≥11.2 (161) (Note 2, 3)	20 @ 7 (0.5)	Scheme D	
							QR/Ordinary/Any	25.2EC (363EC)	10 @ 7 (0.5)		

Notes:

1. See Section D.1 for explanation of abbreviations. See Section D.2.2 for fire protection schemes.
2. If a foam-water sprinkler system is used, use of K 8.0 (K115) ceiling sprinklers is acceptable as long as an equivalent flow is provided from the K8.0 (K115) sprinkler.
3. The K19.6 (K280) sprinkler is not acceptable for use.

2.4.7.2 Protect storage of liquids with flash points at or above 200°F (93°C) as follows:

- A. Provide sprinkler protection per Tables 2.4.7.2.1 or 2.4.7.2.2, as applicable, based on storage arrangement, roof/ceiling height, and storage height.
- B. Semi-solid liquids with flash points at or above 200°F (93°C) in bag-in-box type containers (i.e., plastic bag in a corrugated box) up to 10 gal (38 L) in size can be protected in accordance with Table 2.4.7.2.1.

2.4.7.3 Protect storage of Group 1, 2, 3, and 4 water-miscible liquids as follows:

- A. Provide sprinkler protection per Tables 2.4.7.3.1 or 2.4.7.3.2, as applicable, based on storage arrangement, roof/ceiling height, and storage height.
- B. Protect Group 5 water-miscible liquids as non-ignitable liquids. Use Data Sheet 8-1, *Commodity Classification*, to determine the appropriate commodity classification.

Table 2.4.7.2.1. Rack Storage of Liquids in Plastic or Glass Containers with Flash Points At or Above 200°F (93°C)(Note 1)

Flash Point	Container Size	Maximum Ceiling Height ft (m)	Maximum Storage Height ft (m)	Packaging Type	Minimum Aisle Width ft (m)	Rack Type	Ceiling Sprinkler Protection			In-Rack Sprinkler Protection	
							Response/Nominal Temperature Rating/ Orientation	K-factor gpm/psi ^{1/2} (L/min/bar ^{1/2})	Design, # of Sprinklers @ Pressure psi (bar)		
≥200°F (93°C)	≤ 60 gal (230 L)	Unlimited	Bottom Tier	Uncartoned	8 (2.4)	Single or Double Row	SR/Ordinary/Any	11.2 (161)	30 @ 13 (0.9)	Scheme D	
								14.0 (202)	30 @ 8 (0.6)		
								≥16.8 (235) (Note 2)	30 @ 7 (0.5)		
							QR/Ordinary/Any	25.2EC (363 EC)	16 @ 10 (0.7)		
	≤6.5 gal (25 L)	Unlimited	Unlimited	Uncartoned and/or Cartoned	4 (1.2)	Any	Any	Any	Minimum 0.2 gpm/ft ² (8 mm/min)	Scheme A	
Very high flash point liquid	≤ 60 gal (230 L)	Unlimited	Unlimited	Uncartoned	8 (2.4)	Single or Double Row	Any	Any	Minimum 0.2 gpm/ft ² (8 mm/min)	Scheme A	
	≤6.5 gal (25 L)	Unlimited	Unlimited	Uncartoned and/or Cartoned	4 (1.2)	Any	Any	Any	Minimum 0.2 gpm/ft ² (8 mm/min)	Scheme A	
											40 (12.1)
					Cartoned Only	8 (2.4)	Single or Double Row	SR/Ordinary/Any	QR/Ordinary/Any	25.2EC (363EC)	11 @ 7 (0.5)
									11.2 (161)	20 @ 29 (2.0)	Scheme C
									14.0 (202)	20 @ 18 (1.2)	
				16.8 (235)					20 @ 13 (0.9)		
								25.2 (363)	20 @ 7 (0.5)		
							QR/Ordinary/Any	25.2EC (363EC)	11 @ 22 (1.5)		

Table 2.4.7.2.1. Rack Storage of Liquids in Plastic or Glass Containers with Flash Points At or Above 200°F (93°C) (Note 1) (continued)

Flash Point	Container Size	Maximum Ceiling Height ft (m)	Maximum Storage Height ft (m)	Packaging Type	Minimum Aisle Width ft (m)	Rack Type	Ceiling Sprinkler Protection			In-Rack Sprinkler Protection		
							Response/Nominal Temperature Rating/ Orientation	K-factor gpm/psi ^{1/2} (L/min/bar ^{1/2})	Design, # of Sprinklers @ Pressure psi (bar)			
Very high flash point liquid	≤6.5 gal	30 (9.1)	25 (7.6)	Uncartoned and/or Cartoned	8 (2.4)	Single or Double Row	SR/Ordinary/Any	≥11.2 (161) (Note 2)	20 @ 7 (0.5)	Scheme C		
							QR/Ordinary/Any	25.2EC (363EC)	11 @ 7 (0.5)			
							QR/Ordinary/Pendent	14.0 (202)	12 @ 75 (5.2)		None	
				Cartoned Only	4 (1.2)	Any	16.8 (235)	12 @ 52 (3.6)				
							SR/Ordinary/Any	≥11.2 (161) (Note 2)	20 @ 7 (0.5)	Scheme B		
							QR/Ordinary/Any	25.2EC (363EC)	11 @ 7 (0.5)			
			8 (2.4)	Single or Double Row	QR/Ordinary/Pendent	14.0 (202)	12 @ 75 (5.2)	None				
					16.8 (235)	12 @ 52 (3.6)						
					SR/Ordinary/Any	≥11.2 (161) (Note 2)	20 @ 7 (0.5)	Scheme C				
					QR/Ordinary/Any	25.2EC (363EC)	11 @ 7 (0.5)					
					15 (4.6)	Uncartoned and/or Cartoned	4 (1.2)	Any	SR/Ordinary/Any	≥11.2 (161) (Note 2)	20 @ 7 (0.5)	Scheme B
									QR/Ordinary/Any	25.2EC (363EC)	11 @ 7 (0.5)	
QR/Ordinary/Pendent	14.0 (202)	12 @ 50 (3.5)	None									
Cartoned Only	4 (1.2)	Any		16.8 (202)		12 @ 35 (2.4)						
				SR/Ordinary/Any		≥11.2 (161) (Note 2)	20 @ 7 (0.5)	Scheme B				
			QR/Ordinary/Any	25.2EC (363EC)		11 @ 7 (0.5)						
Very high flash point liquid	<48 oz (1.4 l)	40 (12.1)	35 (10.7)	Cartoned Only	4 (1.2)	Single or Double Row	QR/Ordinary/Pendent	25.2 (363)	12 @ 40 (2.8)	Scheme C (1 level of in-rack sprinklers) at 10 to 15 ft (3 to 4.6 m) above floor		

Notes:
 1. See Section D.1 for explanation of abbreviations. See Section D.2.2 for fire protection schemes.
 2. The K19.6 (K280) sprinkler is not acceptable for use.

Table 2.4.7.2.2. Palletized/Solid Pile Storage of Liquids with Closed-Cup Flash Points At or Above 200°F (93°C) in Plastic Containers (Note 1)

Liquid Type, Flash Point	Container Size	Packaging Type	Maximum Ceiling Height ft (m)	Maximum Storage Height ft (m)	Ceiling Sprinkler Protection		
					Response / Nominal Temperature Rating / Orientation	K-factor gpm/psi ^{1/2} (L/min/bar ^{1/2}) (Note 2)	Design, # of Sprinklers @ Pressure psi (bar)
≥200°F (93°C)	≤6.5 gal (25 L)	Cartoned Only	40 (12.1)	15 (4.6)	QR/Ordinary/Pendent	14.0 (202)	12 @ 75 (5.2)
						16.8 (235)	12 @ 50 (3.5)
			30 (9.1)	15 (4.6)	QR/Ordinary/Pendent	14.0 (202)	12 @ 50 (3.5)
						16.8 (235)	12 @ 35 (2.4)
					SR/Ordinary/Any	11.2 (161)	25 @ 51 (3.5)
						14.0 (202)	25 @ 33 (2.3)
						16.8 (235)	25 @ 23 (1.6)
						25.2 (363)	25 @ 10 (0.7)
					QR/Ordinary/Any	25.2EC (363EC)	13 @ 39 (2.7)
					5 (1.5)	5 (1.5)	QR/Ordinary/Pendent
			16.8 (235)	12 @ 35 (2.4)			
			SR/Ordinary/Any	11.2 (161)			25 @ 29 (2.0)
				14.0 (202)			25 @ 18 (1.2)
				16.8 (235)			25 @ 13 (0.9)
				25.2 (363)			25 @ 7 (0.5)
			QR/Ordinary/Any	25.2EC (363EC)	13 @ 22 (1.5)		

Table 2.4.7.2.2. Palletized/Solid Pile Storage of Liquids with Closed-Cup Flash Points At or Above 200°F (93°C) in Plastic Containers (Note 1) (continued)

Liquid Type, Flash Point	Container Size	Packaging Type	Maximum Ceiling Height ft (m)	Maximum Storage Height ft (m)	Ceiling Sprinkler Protection			
					Response / Nominal Temperature Rating / Orientation	K-factor gpm/psi ^{1/2} (L/min/bar ^{1/2}) (Note 2)	Design, # of Sprinklers @ Pressure psi (bar)	
Very high flash point liquid	≤6.5 gal (25 L)	Uncartoned and/or Cartoned	40 (12.1)	15 (4.6)	QR/Ordinary/Pendent	14.0 (202)	12 @ 75 (5.2)	
						16.8 (235)	12 @ 50 (3.5)	
					30 (9.1)	15 (4.6)	QR/Ordinary/Pendent	14.0 (202)
			16.8 (235)	12 @ 35 (2.4)				
			SR/Ordinary/Any	11.2 (161)			20 @ 51 (3.5)	
				14.0 (202)		20 @ 33 (2.3)		
				16.8 (235)		20 @ 23 (1.6)		
			5 (1.5)	15 (4.6)		QR/Ordinary/Pendent	25.2 (363)	20 @ 10 (0.7)
					25.2EC (363EC)		10 @ 39 (2.7)	
	SR/Ordinary/Any	14.0 (202)			12 @ 50 (3.5)			
		16.8 (235)		12 @ 35 (2.4)				
		11.2 (161)		25 @ 29 (2.0)				
	≤1 gal (4 L)	Cartoned Only		30 (9.1)	20 (6)	QR/Ordinary/Any	14.0 (202)	25 @ 18 (1.2)
			16.8 (235)				25 @ 13 (0.9)	
			SR/Ordinary/Any			25.2 (363)	25 @ 7 (0.5)	
				25.2EC (363EC)	13 @ 22 (1.5)			
				11.2 (161)	20 @ 51 (3.5)			
			≤48 oz (1.4 L)	Uncartoned and/or Cartoned	30 (9.1)	15 (4.6)	QR/Ordinary/Any	14.0 (202)
16.8 (235)								20 @ 23 (1.6)
SR/Ordinary/Any							25.2 (363)	20 @ 10 (0.7)
					25.2EC (363EC)	10 @ 39 (2.7)		
	11.2 (161)	35 @ 29 (2.0)						
QR/Ordinary/Any	14.0 (202)	35 @ 18 (1.2)						
	16.8 (235)	35 @ 13 (0.9)						
	25.2 (363)	35 @ 7 (0.5)						
25.2EC (363EC)	18 @ 22 (1.5)							

Notes:
 1. See Section D.1 for explanation of abbreviations. See Section D.2.2 for fire protection schemes
 2. The K19.6 (K280) sprinkler is not acceptable for use in this protection table.

Table 2.4.7.3.1. Rack Storage of Group 1, 2, 3, and 4 Water-Miscible Liquids in Plastic or Glass Containers (Note 1)

Water-miscible Group (see Section 3.2.1)	Container Size	Maximum Ceiling Height ft (m)	Maximum Storage Height ft (m)	Packaging Type	Minimum Aisle Width ft (m)	Rack Type	Ceiling Sprinkler Protection			In-Rack Sprinkler Protection			
							Response / Nominal Temperature Rating / Orientation	K-factor gpm/psi ^{1/2} (L/min/bar ^{1/2})	Design, # of Sprinklers @ Pressure psi (bar)	Layout	Response / Nominal Temperature Rating	K-factor gpm/psi ^{1/2} (L/min/bar ^{1/2})	Design Flow gpm (L/min) (See 2.4.1.5) (Note 3)
Group 1, 2, 3 & 4	≤60 gal(230 L)	40 (13.7)	30 (9.1)	Uncartoned and/or Cartoned	8 (2.4)	Single or Double Row	SR/Ordinary/Any	≥11.2 (161) (Note 2)	20 @ 7 (0.5)	Scheme D			
							QR/Ordinary/Any	25.2EC (363EC)	10 @ 7 (0.5)				
	≤ 6.5 gal(25 L)	35 (11)	10 (3)	Uncartoned and/or Cartoned	8 (2.4)	Single or Double Row	SR/Ordinary/Any	11.2 (161)	30 @ 13 (0.9)	Scheme A			
								14.0 (202)	30 @ 8 (0.6)				
								≥16.8 (235) (Note 2)	30 @ 7 (0.5)				
	≤1 gal(4 L)	Unlimited	Unlimited	Cartoned Only	Any	Any	Any	Minimum 0.2 gpm/ft ² (8 mm/min)		Scheme A			
	≤6 oz(180 ml)	30 (9.1)	25 (7.6)	Cartoned Only	8 (2.4)	Single or Double Row	QR/Ordinary/Pendent	14.0 (202)	12 @ 50 (3.4)	None			
								16.8 (235)	12 @ 35 (2.4)				
								22.4 (310)	12 @ 25 (1.7)				
								25.2 (363)	12 @ 20 (1.4)				
							SR/Ordinary/Any	11.2 (161)	20 @ 29 (2.0)	Fig. D.2.1.44, D.2.1.45	QR/Ordinary	≥8.0 (115)	45 (170)
								14.0 (202)	20 @ 18 (1.2)				
								16.8 (235)	20 @ 13 (0.9)				
QR/Ordinary/Any							25.2EC (363EC)	10 @ 22 (1.5)					
							SR/Ordinary/Any	≥11.2 (161) (Note 2)	20 @ 7 (0.5)	Fig. D.2.1.42, D.2.1.43	QR/Ordinary	≥8.0 (115)	45 (170)
QR/Ordinary/Any							25.2EC (363EC)	10 @ 7 (0.5)					
40 (12)	35 (10.6)	Cartoned Only	8 (2.4)	Single or Double Row	QR/Ordinary/Pendent	14.0 (202)	12 @ 75 (5.2)	None					
						16.8 (235)	12 @ 52 (3.6)						
						22.4 (310)	12 @ 45 (3.1)						
						25.2 (363)	12 @ 40 (2.8)						

Table 2.4.7.3.1. Rack Storage of Group 1, 2, 3, and 4 Water-Miscible Liquids in Plastic or Glass Containers (Note 1) (continued)

Water-miscible Group (see Section 3.2.1)	Container Size	Maximum Ceiling Height ft (m)	Maximum Storage Height ft (m)	Packaging Type	Minimum Aisle Width ft (m)	Rack Type	Ceiling Sprinkler Protection			In-Rack Sprinkler Protection				
							Response / Nominal Temperature Rating / Orientation	K-factor gpm/psi ^{1/2} (L/min/bar ^{1/2})	Design, # of Sprinklers @ Pressure psi (bar)	Layout	Response / Nominal Temperature Rating	K-factor gpm/psi ^{1/2} (L/min/bar ^{1/2})	Design Flow gpm (L/min) (See 2.4.1.5) (Note 3)	
Group 2	≤1 gal (4 L)	Unlimited	Unlimited	Cartoned only	Any	Any	Any	Minimum 0.2 gpm/ft ² (8 mm/min)			Scheme A			
Group 3	≤ 6.5 gal (25 L)	Unlimited	Unlimited	Cartoned only	Any	Any	Any	Minimum 0.2 gpm/ft ² (8 mm/min)			Scheme A			
	≤1 gal (4 L)	30 (9.1)	25 (7.6)	Cartoned Only	8 (2.4)	Single or Double Row	QR/Ordinary/ Pendent	14.0 (202)	12 @ 75 (5.2)	Fig. D.2.1.46, D.2.1.47	QR/Ordinary	≥8.0 (115)	45 (170)	
								16.8 (235) (Note 2)	12 @ 52 (3.6)					
							SR/Ordinary/ Any	11.2 (161)	20 @ 29 (2.0)					
								14.0 (202)	20 @ 18 (1.2)					
								16.8 (235)	20 @ 13 (0.9)					
							25.2 (363)	20 @ 7 (0.5)						
	QR/Ordinary/ Any	25.2EC (363EC)	10 @ 22 (1.5)											
	SR/Ordinary/ Any	≥11.2 (161) (Note 2)	20 @ 7 (0.5)	Fig. D.2.2.3.1, D.2.2.3.2, D.2.2.3.3 (Note 4)	QR/Ordinary	≥8.0 (115)	45 (170)							
		QR/Ordinary/ Any	25.2EC (363EC)					10 @ 22 (1.5)						
≤ 59 oz (1.75 L)	Unlimited	Unlimited	Cartoned	4 (1.2)	Any	SR/Ordinary/ Any	≥11.2 (160)	20 @ 7 (0.5)	Fig. D.2.2.3.1, D.2.2.3.2, D.2.2.3.3 (Note 4)	QR/Ordinary	≥8.0 (115)	45 (170)		
							QR/Ordinary/ Any	25.2EC (363EC)					10 @ 7 (0.5)	
						SR/Ordinary/ Any	11.2 (160)	20 @ 29 (2.0)						
							14.0 (202)	20 @ 18 (1.2)						
							16.8 (235)	20 @ 13 (0.9)						
						25.2 (363)	20 @ 7 (0.5)							
QR/Ordinary/ Any	25.2EC (363EC)	10 @ 22 (1.5)												

©2020 Factory Mutual Insurance Company. All rights reserved.

Table 2.4.7.3.1. Rack Storage of Group 1, 2, 3, and 4 Water-Miscible Liquids in Plastic or Glass Containers (Note 1) (continued)

Water-miscible Group (see Section 3.2.1)	Container Size	Maximum Ceiling Height ft (m)	Maximum Storage Height ft (m)	Packaging Type	Minimum Aisle Width ft (m)	Rack Type	Ceiling Sprinkler Protection			In-Rack Sprinkler Protection				
							Response / Nominal Temperature Rating / Orientation	K-factor gpm/psi ^{1/2} (L/min/bar ^{1/2})	Design, # of Sprinklers @ Pressure psi (bar)	Layout	Response / Nominal Temperature Rating	K-factor gpm/psi ^{1/2} (L/min/bar ^{1/2})	Design Pressure gpm (L/min) (See 2.4.1.5) (Note 3)	
Group 4	≤ 6.5 gal (25 L)	Unlimited	Unlimited	Cartoned only	Any	Any	Any	Minimum 0.2 gpm/ft ² (8 mm/min)			Scheme A			
	≤1 gal (4 L)	30 (9.1)	25 (7.6)	Cartoned Only	8 (2.4)	Single or Double Row	QR/Ordinary/Pendent	14.0 (202)	12 @ 50 (3.4)	None	Fig. D.2.1.44, D.2.1.45	QR/Ordinary	≥8.0 (115)	45 (170)
								16.8 (235)	12 @ 35 (2.4)					
								22.4 (310)	12 @ 25 (1.7)					
								25.2 (363)	12 @ 20 (1.4)					
							SR/Ordinary/Any	11.2 (161)	20 @ 29 (2.0)					
								14.0 (202)	20 @ 18 (1.2)					
								16.8 (235)	20 @ 13 (0.9)					
								25.2 (363)	20 @ 7 (0.5)					
	QR/Ordinary/Any	25.2EC (363EC)	10 @ 22 (1.5)											
		SR/Ordinary/Any	≥11.2 (161) (Note 2)	20 @ 7 (0.5)	Fig. D.2.1.42, D.2.1.43									
	QR/Ordinary/Any	25.2EC (363EC)	10 @ 7 (0.5)	Fig. D.2.1.44, D.2.1.45	QR/Ordinary	≥8.0 (115)	45 (170)							
SR/Ordinary/Any		≥11.2 (161) (Note 2)	20 @ 7 (0.5)											
QR/Ordinary/Any	15 (4.6)	Cartoned Only	8 (2.4)	Single or Double Row	SR/Ordinary/Any	≥11.2 (161) (Note 2)	20 @ 7 (0.5)	Fig. D.2.1.44, D.2.1.45	QR/Ordinary	≥8.0 (115)	45 (170)			
						QR/Ordinary/Any	25.2EC (363EC)					10 @ 7 (0.5)		

- Notes:
- See Section D.1 for explanation of abbreviations. See Section D.2.2 for fire protection schemes.
 - The K19.6 (K280) sprinkler is not acceptable for use.
 - Base the in-rack sprinkler water demand on the simultaneous operation of the most hydraulically remote sprinklers as follows:
 - Eight (8) sprinklers where only one level of in-rack sprinklers is installed.
 - Fourteen (14) sprinklers (seven on each two top levels) where two levels of in-rack sprinklers are installed.
 - Eighteen (18) sprinklers (six on top three levels) where more than two levels of in-rack sprinklers are installed.
 - The in-rack discharge pressure as provided in Table 2.4.7.3.1.
 - Where the figures referred to are part of the fire protection for Scheme C, only use the figures; do not apply the entire fire protection scheme.

Table 2.4.7.3.2. Palletized/Solid Pile Storage of Groups 1 through 4 Water-Miscible Liquids in Plastic or Glass Containers (Note 1)

Liquid Type (Note 2)	Container Size, Type	Packaging Type	Maximum Ceiling Height ft (m)	Maximum Storage Height ft (m)	Ceiling Sprinkler Protection		
					Response / Nominal Temperature Rating / Orientation	K-factor gpm/psi ^{1/2} (L/min/bar ^{1/2})	Design, # of Sprinklers @ Pressure psi (bar)
Group 1 or 2	≤16 oz (500 ml), Any	Cartoned Only	30 (9.1)	12 (3.7)	QR/Ordinary/Pendent	14.0 (202)	12 @ 50 (3.4)
						16.8 (235)	12 @ 35 (2.4)
					SR/Ordinary/Any	11.2 (161)	25 @ 51 (3.5)
						14.0 (202)	25 @ 33 (2.3)
						16.8 (235)	25 @ 23 (1.6)
				25.2 (363)	25 @ 10 (0.7)		
				QR/Ordinary/Any	25.2EC (363EC)	13 @ 39 (2.7)	
				8 (2.4)	SR/Ordinary/Any	11.2 (161)	15 @ 51 (3.5)
						14.0 (202)	15 @ 33 (2.3)
						16.8 (235)	15 @ 23 (1.6)
	25.2 (363)	15 @ 10 (0.7)					
	QR/Ordinary/Any	25.2EC (363EC)	8 @ 39 (2.7)				
	5 (1.5)	SR/Ordinary/Any	11.2 (161)	20 @ 29 (2.0)			
			14.0 (202)	20 @ 18 (1.2)			
16.8 (235)			20 @ 13 (0.9)				
25.2 (363)			20 @ 7 (0.5)				
QR/Ordinary/Any			25.2EC (363EC)	10 @ 22 (1.5)			
≤6 oz(180 ml), Any	Cartoned Only	30 (9.1)	15 (4.6)	QR/Ordinary/Pendent	14.0 (202)	12 @ 50 (3.4)	
					16.8 (235)	12 @ 35 (2.4)	
					22.4 (32)	12 @ 25 (1.7)	
					25.2 (363)	12 @ 20 (1.4)	
Group 3	≤59 oz (1.75 L), Plastic	Cartoned Only	30 (9.1)	20 (6.1)	QR/Ordinary/Pendent	14.0 (202)	12 @ 50 (3.4)
						16.8 (235)	12 @ 35 (2.4)
					SR/Ordinary/Any	≥11.2 (161) (Note 3)	35 @ 7 (0.5)
	≤59 oz (1.75 L) Glass or Plastic	Cartoned Only	30 (9.1)	17 (5.2)	QR/Ordinary/Any	14.0 (202)	12 @ 50 (3.4)
						16.8 (235)	12 @ 35 (2.4)
				5 (1.5)	QR/Ordinary/Any	14.0 (202)	20 @ 18 (1.2)
						16.8 (235)	20 @ 13 (0.9)
						QR/Ordinary/Any	14.0 (202)
				40 (12)	QR/Ordinary/Any	16.8 (235)	12 @ 52 (3.6)
						5 (1.5)	QR/Ordinary/Any
16.8 (235)	20 @ 13 (0.9)						

Table 2.4.7.3.2. Palletized/Solid Pile Storage of Groups 1 through 4 Water-Miscible Liquids in Plastic or Glass Containers (Note 1) (continued)

Liquid Type (Note 2)	Container Size, Type	Packaging Type	Maximum Ceiling Height ft (m)	Maximum Storage Height ft (m)	Ceiling Sprinkler Protection		
					Response / Nominal Temperature Rating / Orientation	K-factor gpm/psi ^{1/2} (L/min/bar ^{1/2})	Design, # of Sprinklers @ Pressure psi (bar)
Group 4	≤6.5 gal (25 L), Any	Uncartoned or Cartoned	30 (9.1)	20 (6.1)	QR/Ordinary/Pendent	14.0 (202)	12 @ 50 (3.4)
					SR/Ordinary/Any	11.2 (161)	30 @ 13 (0.9)
						14.0 (202)	30 @ 8 (0.6)
						≥16.8 (235) (Note 3)	30 @ 7 (0.5)
					QR/Ordinary/Any	25.2EC (363EC)	15 @ 10 (0.7)
Propylene glycol or ethylene glycol	≥40 gal (150 L) and ≤60 (230 L)	DNA	30 (9.1)	1 Drum high	SR/Ordinary/Any	≥11.2 (161) (Note 3)	20 @ 7 (0.5)
					QR/Ordinary/Any	25.2EC (363 EC)	10 @ 7 (0.5)
				2 Drums high	SR/Ordinary/Any	11.2 (161)	20 @ 28 (1.9)
					14.0 (202)	20 @ 18 (1.2)	
					16.8 (235)	20 @ 13 (0.9)	
					≥22.4 (310)	20 @ 7 (0.5)	
				QR/Ordinary/Any	25.2EC (363 EC)	10 @ 22 (1.5)	

- Notes:
1. See Section D.1 for explanation of abbreviations. See Section D.2.2 for fire protection schemes
 2. See Section 3.2.1 for definitions of Groups 1 through 4 water-miscible liquids.
 3. The K19.6 (K280) sprinkler is not acceptable for use in this protection table.

2.4.8 Distilled Spirits in Wooden Barrels: Palletized Storage Arrays

2.4.8.1 Limit palletized storage arrays to a maximum of 7 pallets high.

2.4.8.2 Maintain a minimum flue space of 6 in. (150 mm) between adjacent pallets as shown in Figure 2.4.8.2.

2.4.8.2.1 Provide the flue space every 2 to 3 barrels depending on the type of pallet that is used.

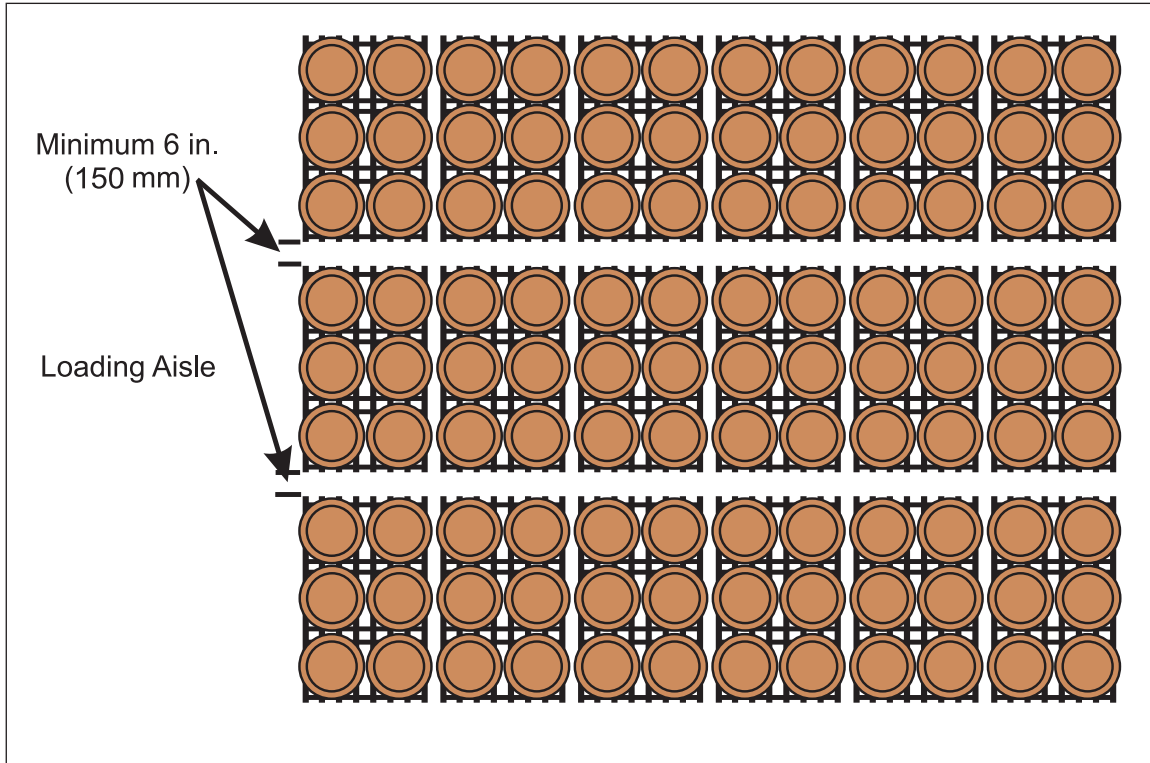

Fig. 2.4.8.2. Minimum flue space between palletized storage arrays (plan view)

2.4.8.3 Arrange palletized storage that is provided with a defined loading aisle using one of the options below:

- A. Provide a draft curtain along the side of palletized storage facing the loading aisle as shown in Figure 2.4.8.3.A. Design the draft curtains in accordance with Data Sheets 1-10 and 2-0.
- B. Provide a trench drain on each side of the loading aisle as shown in Figure 2.4.8.3.B arranged to remove any spilled distilled spirits in the aisle space out of the building and prevent it from spreading into the barrel storage area.
- C. Band all the barrels on each pallet to prevent barrels from falling off the pallet during transportation and loading into the storage array.

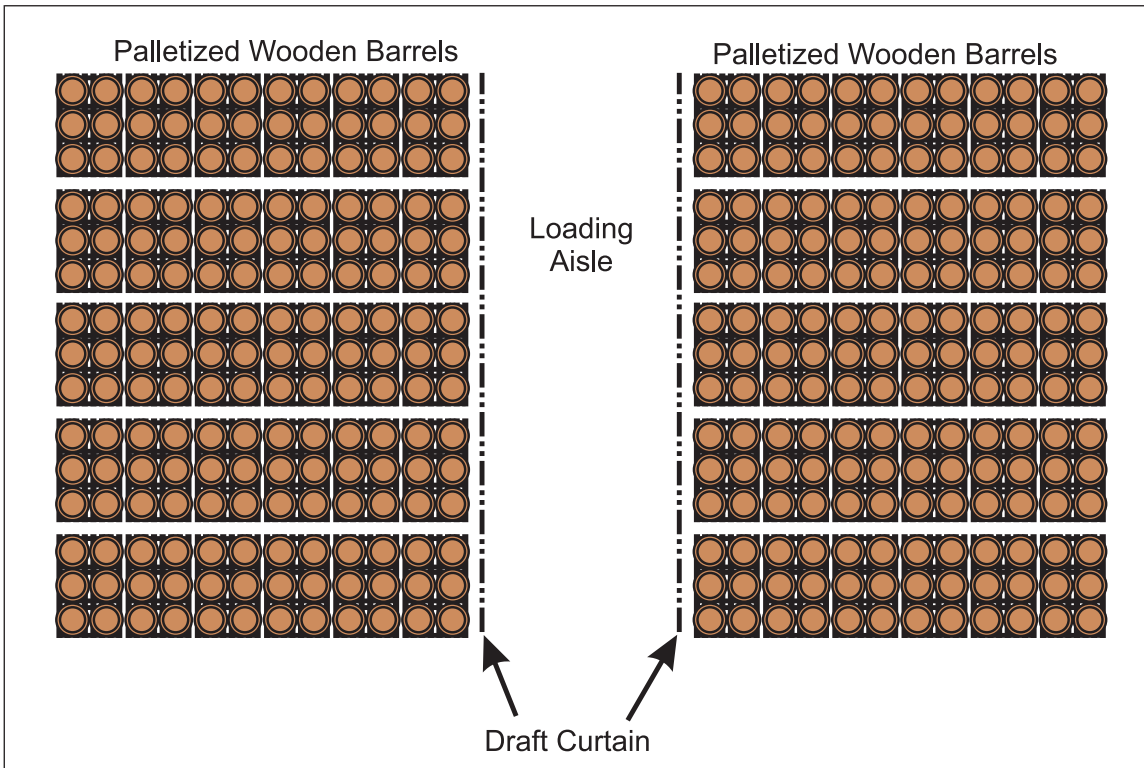

Fig. 2.4.8.3.A. Loading aisle draft curtain arrangement (plan view)

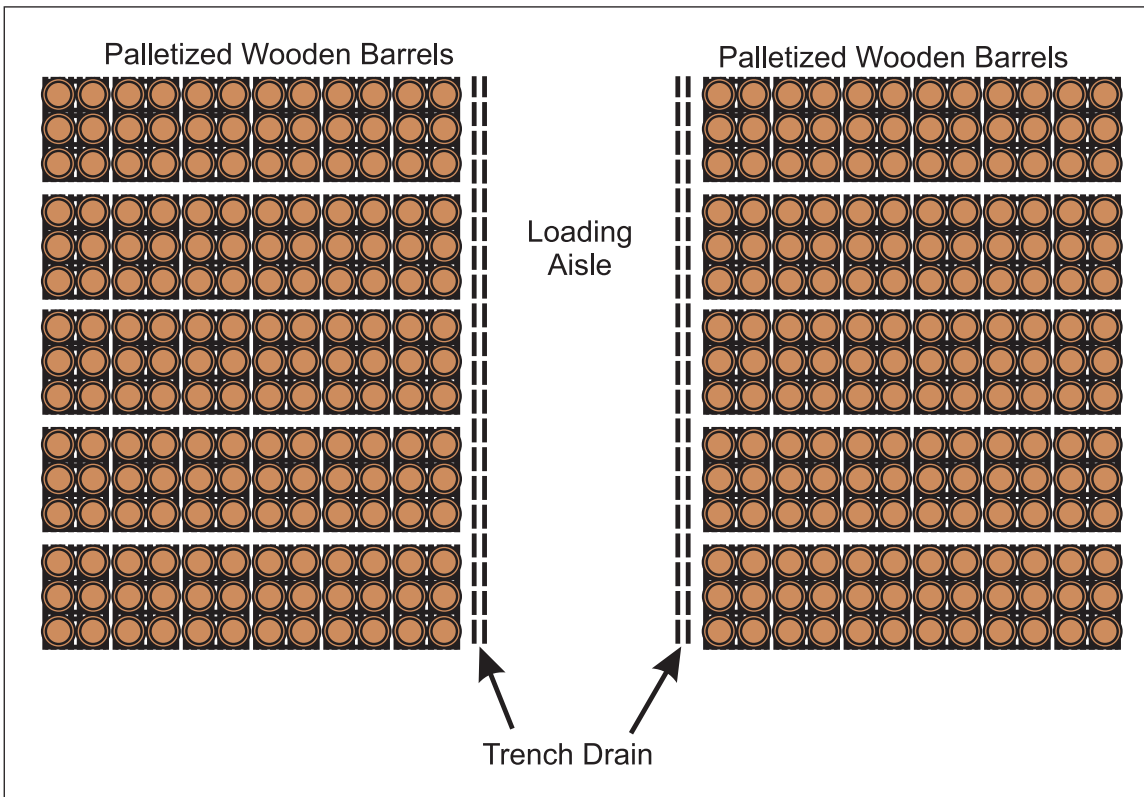

Fig. 2.4.8.3.B. Loading aisle trench drain arrangement (plan view)

2.4.8.5 Protect palletized storage arrangements in accordance with Table 2.4.8.5 and the following criteria:

- A. The protection applies to alcohol-water mixtures up to 75% alcohol and wooden barrel sizes of 53–130 gal (200–500 L).
- B. Provide a 500 gpm (1900 L/min) hose stream allowance.
- C. Provide a water supply that can deliver the total sprinkler and hose stream demand for a duration of at least one hour.
- D. When a permanent loading aisle is provided, the Barrel Storage system and Loading Aisle system do not need to be hydraulically balanced.
- E. If a dry sprinkler system is permitted, provide water delivery within 40 seconds to the most remote 4 sprinklers.

Table 2.4.8.5. Palletized Storage of Distilled Spirits with up to 75% Alcohol by Volume in Wooden Barrels (Note 1)

Protection Area	System Type	Ceiling Height ft (m)	Storage Height ft (m)/# drums	Ceiling Sprinkler Protection		
				Response/ Nominal Temperature Rating/ Orientation	K-factor gpm/psi ^{1/2} (L/min/bar ^{1/2})	Design, # of Sprinklers @ Pressure psi (bar)
Barrel Storage	Wet	30 ft (9.1 m)	24 ft (7.3 m) / 7 drums	QR / Ordinary / Pendent	14.0 (202)	12 @ 18 (1.25)
	Dry			SR / High / Upright	16.8 (240)	24 @ 13 (0.9)
Loading Aisle with Draft Curtain	Wet / Dry		NA	SR / High / Any	5.6 (80)	100 @ 13 (0.9)
					> 8.0 (115) (Note 2)	100 @ 7 (0.5)
Loading Aisle with Trench Drains or Banded Barrels or No Permenant Loading Aisle	Provide the palletized storage design across the entire roof area (i.e., storage area and loading aisle)					

Notes: 1. See Section D.1 for explanation of abbreviations.

2. The K 19.6 (K280) sprinkler is not acceptable for use in this protection table.

2.4.9 Distilled Spirits in Wooden Barrels: Rack Storage Arrays

2.4.9.1 Arrange rack storage arrangements with on-side wooden barrels to provide at least a 17% open area fraction within the rack storage array ignoring any openings in walkways. See Figure 2.4.9.1. (See glossary for definition of open area fraction.)

- A. Flue spaces between adjacent rows of barrels of at least 8 in. (200 mm) wide will provide the needed open area fraction.
- B. If walkways are provided between barrels, use materials that are noncombustible and 50% open. A maximum 1 ft (0.3 m) wide, solid noncombustible walkway is also acceptable as long as there is at least 3 in. (75 mm) between the walkway and the barrel.
- C. If solid combustible walkways are used, provide sprinkler protection below the walkways.

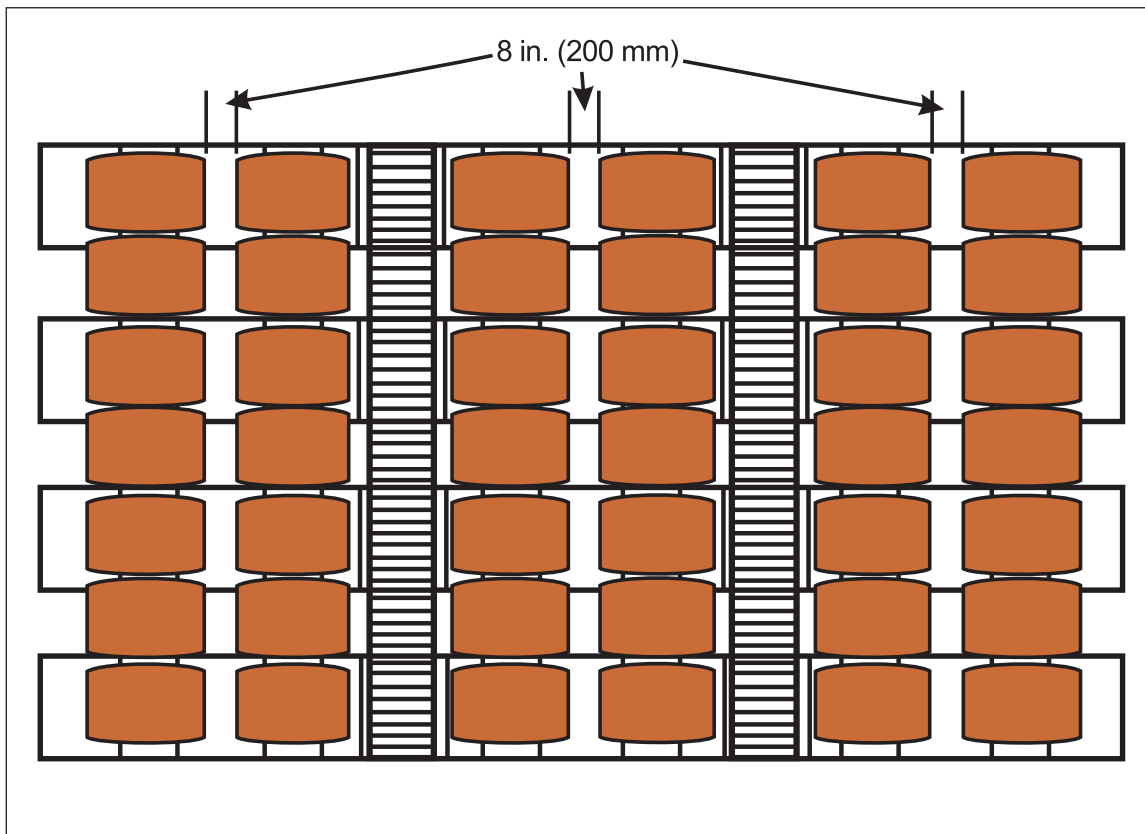

Fig. 2.4.9.1. Flue space and walkway layout for on-side barrel storage in racks (plan view)

2.4.9.2 Arrange rack storage arrangements with on-end wooden barrel to provide at least 6 in. (150 mm) transverse and longitudinal flue spaces.

2.4.9.3 Protect rack storage arrangements in accordance with Table 2.4.9.3 and the following criteria:

- A. Any rack type is acceptable if the needed open fraction and flue spaces are provided.
- B. The protection applies to alcohol-water mixtures up to 75% alcohol and wooden barrel sizes of 53–130 gal (200–500 L).
- C. Provide a 500 gpm (1900 L/min) hose stream allowance.
- D. Provide a water supply that can deliver the total sprinkler and hose stream demand for a duration of at least one hour.
- E. If a dry sprinkler system is permitted, provide water delivery within 40 seconds to the most remote 4 sprinklers.

Table 2.4.9.3. Rack Storage of Distilled Spirits in Wooden Barrels (Note 1)

Barrel Arrangement	Sprinkler System Type	Maximum Ceiling Height ft (m)	Maximum Storage Height ft (m)/# Barrels	Minimum Aisle Width ft (m)	Ceiling Sprinkler Protection			In-Rack Sprinkler Protection			
					Response / Nominal Temperature Rating / Orientation	K-factor gpm/psi ^{1/2} (L/min/bar ^{1/2})	Design, # of Sprinklers @ Pressure psi (bar)	Layout	Response / Nominal Temperature Rating	K-factor gpm/psi ^{1/2} (L/min/bar ^{1/2})	Design Flow gpm (L/min)
On-Side	Wet	40 (12)	33 (10) / 9 barrels	NA	QR / Ordinary / Pendent	14.0 (200)	12 @ 37 (2.5)	None			
					SR / High / Any	≥ 11.2 (160) (Note 2)	20 @ 7 (0.5)	Fig D.2.1.48 and D.2.1.49	QR / Ordinary / Any	8.0 (115)	6 @ 45 (170) [one level of in racks] or 12 @ 45 (170) [more than one level of in racks]
	Dry	40 (12)	33 (10) / 9 barrels	NA	SR / High / Upright	16.8 (240)	24 @ 25 (1.7)	None			
					SR / High / Upright	≥ 11.2 (160) (Note 2)	20 @ 7 (0.5)	Fig D.2.1.48 and D.2.1.49	QR / Ordinary / Upright	8.0 (115)	6 @ 45 (170) [one level of in racks] or 12 @ 45 (170) [more than one level of in racks]
On-End	Wet	30 (9.1)	25 (7.6) / 5 barrels	8 (2.4)	SR / High / Any	≥ 11.2 (160) (Note 2)	50 @ 7 (0.5)	Fig D.2.1.4, D.2.1.6, D.2.1.7 and D.2.1.8	QR / Ordinary / Any	≥ 8.0 (115)	6 @ 25 (95) [one level] or 12 @ 25 (95) [more than one level]

Notes: 1. See Section D.1 for explanation of abbreviations.

2. The K19.6 (K280) sprinkler is not acceptable for use in this protection table.

2.4.9.4 Provide a curb between the loading aisle and the racks. This is to help prevent a spill from a dropped barrel spreading under the rack storage.

2.4.9.5 If barrels are filled/emptied in place while in storage, i.e. alcohol is transferred, then apply Data Sheet 7-32. The protection recommendations above remain applicable provided that the maximum anticipated spill is equivalent to the volume of one barrel.

2.4.10 Yard Storage: Any Container Type

2.4.10.1 Provide manual protection consisting of yard hydrants within 200 ft (60 m) of all outside ignitable liquid storage areas.

2.4.10.2 Provide manual foam protection for critical large or high-value storage areas containing liquids with flash points below 200°F (93°C).

A. Provide manual foam protection by a fixed water-spray system, fixed monitor nozzles, or mobile monitor and hose nozzles.

B. Design the system in accordance with Data Sheet 4-7N, *Low Expansion Foam Systems*.

2.5 Operation and Maintenance

2.5.1 Establish a complete maintenance program designed to ensure equipment is operating as it has been engineered to operate.

2.5.1.1 Refer to Data Sheet 9-0, *Asset Integrity*, to evaluate existing programs or as a guide to developing new ones.

2.5.1.2 Include mechanical and electrical equipment in maintenance programs for equipment handling and areas containing ignitable liquids.

2.5.1.3 Follow preventive maintenance schedules closely to prevent the creation of an ignition source (e.g., equipment breakdown and overheating, improperly sealed hazardous area rated electric equipment).

2.5.2 Relocate equipment needing repair or maintenance that uses a cutting torch or other hot work operation to an appropriately arranged and isolated designated hot work location. See Data Sheet 10-3, *Hot Work Management*, for further information.

2.5.3 Operate and maintain the self-supporting rack structures for distilled spirit barrel storage warehouses as follows:

A. Conduct monthly inspections during normal operating periods for evidence of structural movement or instability. Less frequent inspections are permissible during static conditions.

B. Install a permanent plumb line or another suitable measuring system for storage racks over six barrels high. Take readings before and after any large-scale loading or removal operations.

C. Load and unload evenly to prevent unbalanced forces on the racks. Where practical, load lower tiers first; when unloading, start with upper tiers.

D. Report and evaluate abnormal conditions promptly to determine if corrective action is needed.

E. Provide lightning protection for all warehouse buildings installed in accordance with Data Sheet 5-11, *Lightning and Surge Protection for Electrical Systems*.

2.6 Training

2.6.1 Create a training program for all employees (including lift truck operators, emergency response team members, and security personnel) who have access to or work in areas containing ignitable liquid storage. Provide training for all new employees, with refresher programs as needed. At a minimum, include the following subjects in the program:

A. The hazards created by the liquids and their associated containers

B. Proper liquid/container handling procedures (i.e., lift truck operations, liquid transport through the facility, etc.)

- C. Emergency procedures, including the location, proper type and proper use of fire extinguishers and small hose stations
- D. Fixed extinguishing systems operation and function
- E. The consequences of failing to follow the procedures

2.7 Human Factor

2.7.1 Establish a formal property conservation program in accordance with Data Sheet 10-0, *The Human Factor of Property Conservation*.

2.7.2 Establish an emergency response plan designed to control the extent of damage due to fire in accordance with Data Sheet 10-2, *Emergency Response*, at locations storing ignitable liquids.

2.7.2.1 Include spill-response procedures aimed at limiting spill size (e.g., prompt removal of breached containers), containing released liquid (e.g., use of sand bags or other barriers), and elimination of all ignition sources that may be exposed by the spill or flammable vapor until the spill is cleaned up.

2.7.2 Develop and maintain a pre-incident plan in accordance with Data Sheet 10-1, *Pre-Incident Planning*. Use emergency response drills to reinforce the employee training programs (including emergency response team).

2.7.3 Arrange security rounds to include all areas storing ignitable liquids. Train security personnel to recognize and provide prompt notification of a leak.

2.7.4 Provide a raw materials inspection program to ensure delivery of expected liquids and prevent the introduction of incompatible liquids into a storage facility. Only accept, ship, and use containers that comply with U.S. Department of Transportation (DOT), United Nations, or equivalent specifications. Maintain the vapor space no less than that permitted by the specific regulation.

2.7.5 Conduct fusible closure supervision in accordance with the following recommendations at locations where FM Approved fusible closures for steel drums are used.

2.7.5.1 Develop a management reporting system that includes:

- A. Qualified personnel responsible for program implementation.
- B. Periodic management audits to ensure the program is implemented as intended.

2.7.5.2 Create purchasing requirements that include:

- A. A list of qualified suppliers.
- B. A list of FM Approved fusible closures that are installed by each supplier.

2.7.5.3 Develop drum inspection requirements for receiving and storage areas that include:

- A. Visual inspections to ensure FM Approved fusible closures are installed on all incoming drums.
- B. Recorded incoming drum inspections.
- C. An up-to-date list of qualified suppliers and FM Approved fusible closures.
- D. Clear authorization to reject any shipments containing non-Approved fusible closures.
- E. Reporting requirement for any unsatisfactory conditions to ensure prompt corrective measures.

2.7.5.4 Provide awareness training for employees who receive and handle drums fitted with FM Approved fusible closures. Ensure the training addresses the following:

- A. Role of FM Approved fusible closures and proper storage practices
- B. Potential consequences of unapproved fusible closures and improper storage
- C. Recognizing FM Approved and unapproved fusible closures
- D. Inspection and reporting procedures
- E. Initial training and periodic refreshers

2.7.5.5 Provide documentation of all procedures, suppliers, inspection records, and training. Ensure documentation is maintained in a central location on site that is accessible for loss prevention audits.

2.7.5.6 Use Management of Change procedures to:

- A. Maintain an up-to-date roster of designated employees and their role in fusible closure supervision.
- B. Communicate new suppliers and fusible closure manufacturers to all areas of the supervision program.

2.7.6 Clearly label all containers filled with ignitable liquids. Inspect drums for leaks upon receipt, when in use, and while stored. Promptly remove any leaking, corroded, or damaged drums, and immediately clean up any spillage and dispose of it in a manner acceptable to the authority having jurisdiction.

2.7.7 Strictly control all changes in storage arrangements, locations, and types of ignitable liquids. Conduct a full review of all planned changes with qualified loss prevention consultants as well as other authorities having jurisdiction before the project begins.

2.8 Ignition Source Control

2.8.1 Use Table 2.8.1 to determine areas needing rated electrical equipment.

2.8.1.1 Do not use non-rated portable electrical equipment in areas requiring rated electrical equipment.

2.8.1.1.1 If such equipment must be temporarily introduced, treat this as hot work and follow the permit precautions. As with other hot work, if the precautions cannot be taken, do not issue the permit and do not use the non-rated electrical equipment.

2.8.1.2 In distilled spirit maturation warehouses, provide Class I, Division 2, Group D rated leak-hunters, extension lights, barrel stackers, grade level wall outlets, and below-grade electrical installations.

Table 2.8.1. Electrical Equipment Ratings and Lift Truck Ratings for Ignitable Liquids Storage Occupancies

Liquid Type	Container Size	Electrical Equipment Rating within 6 ft (1.8 m) of Floor Level		Lift Truck Rating for Handling or Transporting Liquids
		US (NEC 500)	US (NEC 505) IECENELEC	
<BP 100°F (38°C)	Any	Class 1 Division 2	Class 1 Zone 2	Type EE or DY
<FP 100°F (38°C) AND BP ≥ 100°F (38°C)	Any	Ordinary	Ordinary	Type EE or DY [R] Ordinary
FP ≥100°F(38°C)	Any	Ordinary	Ordinary	Ordinary

Note: FP = flash point, and BP = boiling point.

2.8.2 Use Table 2.8.1 to determine when lift trucks that are FM Approved for Class 1, Division 2 locations are needed to handle and/or transport liquid storage.

2.8.2.1 Use of electric Type E, gasoline Type GS, diesel Type DS, and LP-gas Type LPS to transport all liquid types outdoors is acceptable.

2.8.2.2 Use of air-powered or manually-operated hoists, hand trucks, or other manual equipment are acceptable and are generally preferred for use with all ignitable liquids.

2.8.2.3 Do not use hydrogen fuel cell lift trucks for handling ignitable liquids since they are not currently rated for hazardous location use and may create an explosion hazard if they are fueled in the building where they are being used.

2.8.2.4 Rated lift trucks are not required for liquids stored in general purpose warehouses.

2.8.3 Provide grounding in accordance with Data Sheet 5-8, *Static Electricity*; Data Sheet 5-10, *Protective Grounding for Electric Power Systems and Equipment*; and NFPA 70, *National Electrical Code*, Articles 250 and 500, for equipment subject to static accumulations, such as racks, ventilating ducts, hoists, etc. Proper grounding of equipment reduces the potential for buildup of electric charge on separated pieces of equipment due to static accumulations or stray electric currents.

2.8.4 Prohibit smoking or the use of open flames in all rooms, buildings, or outdoor storage areas that are used for the storage of ignitable liquids. Post conspicuous signs to define hazardous areas and state restrictions for the area.

2.8.5 When heating rooms or buildings, including hot box or warming room, that contain ignitable liquid storage, use a system that does not introduce an ignition source (e.g., steam, hot water, or hazardous location rated electric heat).

2.8.5.1 Direct natural gas/fuel oil-fired make-up air heaters are acceptable if the heating unit is located outside the room or building and there is no air recirculation.

2.8.5.2 Keep heating equipment surface temperatures below the auto-ignition point of the liquids present in the room.

2.8.5.3 Keep heating equipment at least 5 ft (1.5 m) away from liquid storage containers.

2.8.5.4 If storage containers are opened in the room, use Data Sheet 7-32, *Ignitable Liquid Operations*, to evaluate the room/building.

2.8.6 Do not allow hot work of any kind in areas (indoors and outdoors) storing ignitable liquids. Instead, use methods that do not create a potential ignition source, or relocate any hot work to a nonhazardous location. When relocation is not possible, use the FM Global Hot Work Permit System. See Data Sheet 10-3, *Hot Work Management*.

3.0 SUPPORT FOR RECOMMENDATIONS

3.1 General

3.1.1 Composite Intermediate Bulk Containers (IBC)

3.1.1.1 Non-FM Approved Composite IBCs

Composite IBCs are designed to transport and store liquids, including ignitable liquids. The various transportation codes around the world evaluate the IBCs for integrity during transportation activities. However, the containers are not evaluated for their ability to resist failure when exposed to fire regardless of the type of liquid storage.

Fire testing has demonstrated that composite IBCs can quickly fail when exposed to even a small packaging fire, resulting in the release of the liquid. Composite IBCs containing ignitable liquid will create very large pool fires that involve the contents of all containers exposed to the fire.

The only protection criteria available for these units requires significant in-rack sprinkler protection plus isolation because multiple containers can still fail. Ignitable liquids are limited to:

- Liquids with a flash point of 200°F (93°C) or higher
- Ethyl, isopropyl or methyl alcohols

In addition, there are a couple of liquids with reduced fire hazards that can also be stored in IBCs. Those ignitable liquids are:

- Propylene or ethylene glycol
- Very high flash point liquids

3.1.1.2 FM Approved Composite IBCs

FM Approved composite IBCs are expected to prevent leakage of the stored ignitable liquid, even when exposed to a pool fire, when protected per this data sheet. The FM Approvals fire test consists of a pool fire using the type of liquid stored in the IBC. IBCs are arranged in a 2 x 2 x 2 high array under a 30 ft (9 m) ceiling. The IBCs sit in a 14 ft x 14 ft (4.3 m x 4.3 m) pan filled with the same liquid that is stored in the IBCs, simulating a release from one unit. Automatic sprinkler protection is provided and arranged to deliver a density of 0.6 gpm/ft² (24 mm/min). To pass, the IBCs must not release the stored liquid into the pool fire during the test.

Currently, FM Approved composite IBCs are only Approved for use with liquids that have a flash point greater than or equal to 200°F (93°C).

3.2 Liquid Evaluation

The first step in evaluating the storage of ignitable liquids is to determine the actual fire hazard presented by the liquid. Current labeling practices required by many codes and liquid classification schemes are not a good indication of the fire hazard of a liquid. Even the measurable physical properties of liquids do not always provide enough information to determine the fire hazard created by a particular stored liquid.

The fire hazard of an ignitable liquid is determined by both inherent physical properties of the liquid and external factors such as container construction, container size, storage arrangement, and building construction. Two measures of fire severity are heat release rate and flame height. For liquid fires, the heat release rate is controlled by the surface area of the liquid, the liquid's heat of combustion, and the mass loss rate of the liquid. The flame height is controlled by the fire's heat release rate. The heat of combustion and mass loss rate are physical properties of the liquid. The surface area available to burn is dependent on numerous external factors such as liquid release method (spray release, liquid stream, catastrophic mass release), floor surface and pitch (rough surface and/or floor pitch will limit liquid spread), and container construction (combustible containers will release liquid while most noncombustible containers will retain liquid if properly protected).

Another factor to consider is the ability to extinguish a liquid pool fire with ceiling sprinkler discharge alone. Previous FM Global testing showed ceiling sprinklers were successful in extinguishing pool fires involving liquids with a closed-cup flash point greater than 200°F (93°C). This result was also supported in more recent FM Global tests on vegetable and motor oils. Using this criteria, hydrocarbon liquids could be divided into two groups: liquids that cannot be extinguished with ceiling sprinkler discharge and liquids that can be extinguished with ceiling sprinkler discharge. The break point would be a closed-cup flash point of 200°F (93°C).

The FM Global test results on motor oil and vegetable oil provided a break point to use for the evaluation of liquids with a flash point greater than 200°F (93°C). The required level of fire protection for vegetable oils in plastic containers is less than that required for motor oil in plastic containers. The closed-cup flash point of the tested vegetable oil was 450°F (232°C). The motor oil tested had a flash point of 375°F (191°C). The main difference between the two tested liquids was the amount of energy needed to ignite the liquids. The higher flash and fire points of the vegetable oil allowed for the use of a reduced protection scheme (i.e., no barriers and one line of in-rack sprinklers) because the released oil was more difficult to ignite and, when ignited, was very easily cooled and extinguished by sprinkler discharge.

Other material/liquid properties that may impact the fire hazard of a liquid include water miscibility, liquid mixtures and emulsions, liquid viscosity, low boiling point liquids (i.e., boiling point below 100°F [38°C]), and liquids that are heavier than water (i.e., specific gravity above 1).

Ultimately, when considering the fire hazard created by liquids, determining if the liquid will burn is the critical factor. If it burns, the liquid creates a significant fire hazard for storage occupancies. Even liquids that create limited fire hazards will create an unacceptable fire in a storage occupancy because they can still create a large-area ignition source. Igniting solid materials in multiple flue spaces is beyond the design basis for current sprinkler criteria for solid commodities. Unfortunately, current codes do not support identifying liquids that will burn. Most codes ignore liquids with flash points greater than 140°F (40°C) and these can burn down a building just as easily as the liquids that require labeling.

3.2.1 Water-Miscible Liquids

See Appendix A for the definition of "water-miscible."

Historically, water-miscible ignitable liquids were thought to require significantly less protection than normal hydrocarbon liquids due to the fact that they can be diluted with water to a point where they cease to burn. This approach actually allowed certain mixtures of water and ignitable liquids to be protected as a solid commodity. Water-miscible liquids do generally have lower heat release rates and low flame radiation (due to limited soot production). Also, as the water percentage of the mixture rises, the flash point and fire point of the mixture increase while the heat of combustion and heat release rate decrease. At some point, the mixture will cease to have a fire point but may still have a flash point. Mixtures that do not have a fire point will not burn. Conversely, if the mixture has a fire point, it will burn and can create a pool fire. Unfortunately, this means products with limited amounts of a water-miscible liquid and a fire point have the potential for creating a pool fire if the liquid release is not controlled or contained during a fire. This could allow fire spread well beyond the area of fire origin. Mixtures that have fire points must always be considered ignitable liquids.

There are only a small number of ignitable liquids that meet the definition of water-miscible provided in this data sheet. The majority of liquids that meet the definition are low molecular weight alcohols and acetone. Only the liquids listed in Table 2.1.2.2 should be considered water-miscible. If a liquid is thought to be water-miscible, it must be confirmed by testing a range of volume percentages to clearly demonstrate its ability to mix in all proportions with water.

Water-miscible liquids do mix with water. However, they are also lighter than water so they float on its surface. The majority of the mixing in a sprinklered pool fire scenario is due to sprinkler discharge impacting the liquid surface. Full-scale tests by FM Global have shown that, although mixing does occur, it is a very slow process and should not be depended on to reduce fire protection needs in a storage arrangement.

Some protection criteria required for water-miscible liquids as a general group can be reduced due to the lower heat release rates and lower flame radiation (e.g., location and construction requirements, sprinkler protection for liquids in metal containers). Some protection criteria (e.g., drainage requirements) can be reduced due to the expected dilution effect of water. In other cases, water-miscible liquids need to be broken down by the specific liquid, liquid concentration, and storage container construction (e.g., sprinkler protection for liquids in plastic containers). Since plastic or glass containers cannot prevent the release of a water-miscible liquid during a fire, the liquid type and concentration must be considered. All water-miscible liquids do not present the same fire hazard. Acetone creates a more severe fire hazard than isopropyl alcohol (IPA). Unfortunately, fire testing conducted to date has only looked at alcohols. This base of test data allows the grouping of all water-miscible alcohols by volume percent. One series of small-scale testing indicates that 80% acetone presents a fire hazard similar to 100% IPA. Since different levels of fire protection criteria are possible for various mixtures of some miscible liquids and water, mixtures with similar fire hazards were grouped.

Miscible liquid mixtures in plastic or glass containers that are not included in the groups have not been evaluated. Use the guidelines in Table 2.4.5.1 to determine acceptable fire protection for these liquids.

3.2.2 Emulsions

There are a number of products that consist of a water base mixed with various percentages of immiscible ignitable liquids and solids. Many of these are emulsions (i.e., the immiscible ignitable liquid does not separate out of the mixture). A common example of this type of product is a water-borne paint or coating. Latex paints generally have little or no ignitable liquid content. Some newer paints have various percentages of ignitable liquid in a water base. The ignitable liquids can be water-miscible or immiscible. Bench-scale testing on a large number of paint products with up to 20% immiscible ignitable liquid has shown these materials to present no measurable fire hazard. Many of these materials cannot be easily tested using standard flash or fire point test methods. However, efforts to ignite larger quantities of liquid than required by these tests also failed to produce any sustained combustion. All emulsion products with unknown ignitable liquid content require testing to confirm if the product has a fire point.

3.2.3 Viscous Liquids/Viscous Mixtures

Viscosity is measured by many different types of tests. Many of the measurements were developed for a particular type of liquid at a fixed temperature. It is not possible to convert between most of the viscosity measurements. One unit of dynamic (absolute) viscosity is a centipoise (cP). One cP is equivalent to 6.72 x 10⁻⁴ lb/sec-ft or 0.01 g/cm-sec. The viscosity of several liquids (at 70°F [21°C]) are as follows:

- Water: 1.0 cP
- Gasoline: 0.65 cP
- Acetone: 0.35 cP
- Lubricating oil (SAE 10): 60 cP
- Glycerin: 1000 cP
- Honey: 10,000 cP
- Asphalt: >100,000 cP

A common unit of measure for kinematic (ratio of kinematic viscosity and density) viscosity is centistokes (cSt). At 68°F (20°C), water has a kinematic viscosity of about 1 cSt.

An important benefit of viscous liquids is their reduced flow capacity. Highly viscous liquids will resist free flow, which results in reduced surface area. As discussed earlier, surface area has a direct impact on liquid fire severity. Unfortunately, the viscosity of many materials decreases with elevated temperatures. Since current viscosity measurement techniques do not provide viscosities at fire temperatures, a reduction in fire hazard for viscous homogenous materials cannot be determined.

There are other liquids that consist of a mixture of solids and an ignitable liquid. In cases where there is a high solid content, a reduction in fire hazard is expected. Liquids with a viscosity of 10,000 cP and less than 10% ignitable liquid, or a viscosity of 100,000 cP and less than 50% ignitable liquid, can be protected using reduced protection criteria. Straight interpolation may be used to calculate the maximum solvent content for mixtures with viscosities between 10,000 cP and 100,000 cP. One example is automobile repair putty, which consists of a viscous base material combined with a small quantity of low flash point solvent.

Liquid drainage systems are not needed for any liquid with a viscosity greater than 10,000 cP. Even though these liquids may experience a reduction in viscosity when exposed to a fire, if the sprinkler protection is adequate, the liquids should cool quickly on the floor. The reduced flow characteristics of a highly viscous liquid negates the effectiveness of a drainage system in removing the liquid.

3.2.4 Liquids with Boiling Point Below 100°F (38°C)

No testing has been conducted on these liquids. Their low boiling point results in rapid vaporization when released. This creates the potential for the formation of an explosive cloud if the liquid is spilled, or the quick buildup of pressure in a sealed container exposed to fire. The impact on the overall fire hazard may be limited. Quick vaporization produces a high mass loss rate that will quickly reduce pool area. These two factors may cancel each other's impact on the overall heat release rate. The key concerns with these liquids is the prevention of a large liquid release that could result in an explosion, and the prevention of container overpressurization during a fire.

3.2.5 Liquids with Specific Gravity Above 1

These liquids can be extinguished by water if the water is given the opportunity to build up over the liquid's surface. Emergency floor drainage is not required for this type of liquid storage as long as adequate containment can be provided to ensure water buildup over the ignitable liquid's surface.

3.2.6 Atypical Ignitable Liquids

3.2.6.1 Very High Flash Point Liquids

Based on the results of several research test programs, FM Global has defined a closed-cup flash point threshold at which liquids will not support fire spread across an unheated liquid pool. This does not mean these liquids will not burn; in fact, they still represent a severe fire hazard when stored in small plastic containers with cardboard packaging.

The following can be treated as very high flashpoint liquids:

- A. Unheated liquids with a flash point at or above 414°F (212°C).
- B. Heated liquids with a flash point at or above 414°F (212°C) that have an operating temperature that meets the following equation:
$$\text{Closed Cup flash point} - \text{Operating temperature} > 324^\circ\text{F} (180^\circ\text{C})$$
- C. Vegetable oils and fish oils with a closed cup flash point of 450°F (232°C) and greater, that are heated to less than or equal to 150°F (65°C).

3.2.6.2 Silicone Fluids and Silicone Emulsions

Historically, silicone fluids have been thought to present a minimal fire hazard because it was believed the silicone dioxide ash produced by burning silicone fluids would act to coat the liquid surface and extinguish the fire. Unfortunately, large pool fires create significant fire plumes that lift even silicone dioxide ash away from the liquid surface. Both small-scale and full-scale fire testing of higher viscosity silicone fluids has shown that they do burn and can make very challenging fires. Testing has also shown that relatively low sprinkler discharge rates can quickly extinguish some pool fires.

3.2.6.3 Paste Ink

Paste inks are commonly used in the printing industry. They generally consist of a vegetable oil base mixed with solids. True paste ink will not flow at room temperature without the application of pressure. Fires involving paste ink are usually localized because the ink tends to accumulate on the floor and not readily spread. Protection criteria for paste ink is provided in Data Sheet 7-96, *Printing Plants*.

3.2.6.4 Water-Based Polyurethane Foam Packaging Systems

Polyurethane packing systems are used at many manufacturing facilities to package product with a secure foam cushion around the product. These polyurethane systems are water-based and consist of two liquid components that, when mixed, react to form polyurethane foam. One component is a polyol. This material is commonly listed with a flash point on its MSDS, however, numerous pool fire tests failed to result in a pool fire. It does not need to be considered an ignitable liquid. When polyurethane is used to manufacture padding for seats or other final products, the polyol is commonly mixed with an oil to create flexible foam. This version of the polyol does burn and is an ignitable liquid.

The second component of the foam packaging is polymethylene polyphenyl isocyanate (PMDI). This is an ignitable liquid; however, the fire hazard it creates is limited. If spilled it will support fire spread across the liquid surface and can release enough energy to activate sprinklers. Sprinkler discharge will quickly extinguish the pool fire. However, a release of this liquid in a general purpose warehouse will result in a very large ignition source. Composite IBC storage of PMDI will quickly fail when exposed to a PMDI pool fire.

3.2.6.5 Butter Products

Butter is a soft yellow or white emulsion made from butterfat, water, air, and sometimes salt. It is churned from milk or cream for use in cooking and as a food.

Butterfat is the natural fat of milk from which butter is made. It is also called milkfat.

Fire testing on butterfat demonstrated that it will not support fire spread across the surface of a liquid pool. In large containers, butterfat can be treated like a very high flash point liquid. This also applies to milk fat.

Consumer packaging of butter can be treated as a Class 3 commodity due to the air and water content within the butter.

3.2.6.6 Unsaturated Polyester Resin (UPR)

UPR is a polyester resin mixture with various amounts of styrene added. UPR is a liquid mixture with the majority of the material being a higher flash point resin and various amounts of styrene, which drives the lower flash point. If the mixture has less than 50% styrene, protection recommendations will vary (refer to Section 2.1.3.6.1). Otherwise, evaluate it as an ignitable liquid using the mixture's flash point.

Spilled UPR will burn as a pool on the floor. It tends to spread less, and have a slower flame spread, than common low flash point liquids. Heating UPR in a metal container will cause polymerization without significantly overpressurizing the container (i.e., container may partially vent without creating overpressure damage in the building). Palletized relieving-style drum storage of UPR can be protected with sprinklers and does not need drainage.

3.2.6.7 Propylene and Ethylene Glycol Mixtures

Propylene and ethylene glycol are water-miscible, high flash point (FP above 200°F [93°C]) ignitable liquids. One big advantage of these liquids over other high flash point or water-miscible liquids (from a protection standpoint) is they quickly cease to produce a fire point with dilution. Bench-scale testing of both ethylene and propylene glycol has shown they no longer produce a fire point once they have been mixed with 20% by volume water. From a pool fire standpoint, this is positive. 80% by volume or less glycol mixed with water does not need to be treated as an ignitable liquid because the liquids will not burn when in a pool on the floor. However, these liquid mixtures can still impact a fire while they are on the surface of burning cellulosic materials. Intermediate-scale testing of glycol water mixtures being discharged onto burning wooden pallets has shown that mixtures with more than 35% by volume glycol will increase the burning rate of the pallets. Based on this information, protection criteria for glycol water mixtures has been provided in this data sheet.

3.3 Construction and Location

The location and construction features provided for ignitable liquid storage are dependent on both the expected fire severity with protection systems in service and the potential for more severe fire scenarios than were designed for. Container size has a significant impact on the potential for a more severe fire scenario. Fire protection designs for larger containers of low flash point liquids are based on a flowing liquid release that is ignited immediately. The amount of the spill is dependent on the container size. The scenario for metal drums assumes a release from two drums on a single pallet. There is a potential for a larger release or a delayed ignition. Both cases could result in a larger fire that will challenge the provided protection scheme. At a minimum, a cutoff room is needed to segregate ignitable liquid drum storage from other less hazardous occupancies.

Many combustible or brittle containers with low flash point, immiscible ignitable liquids cannot be easily protected with existing sprinkler technology. This type of storage needs to be well cutoff from other occupancies since the confidence level in provided protection is low.

Ignitable liquid storage buildings/cutoff rooms must use noncombustible construction. The high intensity of an ignitable liquid fire could ignite combustible construction even in adequately protected facilities. Additional protection is needed to ensure the integrity of steel columns located in buildings or cutoff rooms where a severe fire is expected.

Liquid control is a critical issue in buildings and cutoff rooms storing ignitable liquids. Based on the type and size of container, the level of liquid control can vary. In storage arrays where large spills are possible, strict liquid control via drainage systems and curbing is needed. Storage arrays of small containers with proven protection schemes do not require drainage or containment.

3.4 Ventilation

Ventilation systems are designed to confine, dilute, and remove the normal amount of flammable vapor released from leaks of ignitable liquids in storage or use occupancies. Today's modern containers should not allow any leakage of flammable vapor under normal conditions so specially designed ventilation systems are not generally needed in storage occupancies. Certain highly volatile liquids, like those with boiling points below 100°F (38°C), still justify the use of a specially designed ventilation system due to their high vapor pressures. Warehouses with poorly maintained containers or with liquid dispensing do still need specially designed ventilation systems.

Ventilation is an active system designed to prevent the buildup of flammable vapor due to small leaks or spills. These systems must be properly designed and laid out to ensure all floor areas of the warehouse or cutoff room are covered by the system. In large buildings, a test of the system using a smoke generating device may be needed to ensure the system layout is adequate.

3.5 Protection

3.5.1 General

Determining adequate fire protection for the storage of ignitable liquids is not a straightforward effort. In general, there is a lack of full-scale testing to draw conclusions from due to the high cost and potential risk of conducting this type of testing. However, even if the testing is done, the number of variables that could drastically impact the outcome of a test are incalculable. Potential fire scenarios range from a point ignition of a common combustible material in an ignitable liquids storage occupancy to the ignition of the contents of a 350 gal (1.3 m³) IBC that emptied onto the floor.

For containers larger than 6.5 gal (25 L) in size, the fire scenario used to evaluate protection involves a breached container that leaks ignitable liquid at a fixed rate until empty, with ignition after approximately 10 gal (38 L) has been released. The recommended fire protection may not be adequate for the scenario involving the complete release of a large container before ignition in warehouses or cutoff rooms that are larger than the provided sprinkler operating area. Due to the variability of defining fire protection for ignitable liquids, sprinkler protection alone will not ensure adequate protection. Construction features, space separation, and prevention measures must be included in any ignitable liquid warehouse/cutoff room design.

3.5.2 Automatic Sprinklers

Automatic sprinklers are critical for controlling temperatures in an ignitable liquid fire. Lack of properly designed sprinklers will result in a continued release of ignitable liquid from their storage containers which will continue to increase the pool fire size eventually resulting in the loss of buildings used to store these materials. Due to the near immediate growth of a low flash point ignitable liquid pool fire, the use of dry sprinkler systems is not recommended without full-scale validation testing. The potential delay time for water delivery will allow unchecked temperature growth at the ceiling, resulting in a large number of sprinklers opening. The very rapid fire growth expected does not allow for a fixed increase (i.e., penalty) in sprinkler operating area. A preaction system could be used as long as the provided detection system ensures water delivery to the sprinklers before the sprinklers operate. Deluge systems provide the best level of protection in unheated facilities.

3.5.3 Special Protection Systems

Special protection systems should be installed with caution in an ignitable liquids storage occupancy. All of these systems have inherent limitations that must be recognized and considered before a system is installed. The systems that present the least number of limitations are foam-water sprinkler and compressed air foam (CAF) systems. In a foam-water sprinkler system the foam concentrate is delivered through sprinkler piping to the fire. In a CAF system, a foam-air-water mixture is delivered through a dedicated piping system to special nozzles that discharge the mixture. Open doors or windows or sprinkler discharge will not impact the effectiveness of the foam. However, these systems are complicated and require the proper operation of a number of mechanical and electrical devices.

Gaseous extinguishing and dry chemical systems are not acceptable for protection of ignitable liquids.

3.5.4 Metal Containers

Protecting any size metal container filled with an ignitable liquid requires adequate water to cool the container to prevent its violent rupture or the creation of a jet fire. Palletized storage arrangements significantly limit the ability of ceiling sprinkler discharge to provide cooling to containers that are at the bottom of the storage array. Full-scale fire testing has shown that standard response, small orifice sprinklers (i.e., smaller than K11.2 [K160]) cannot provide adequate protection for palletized arrays of small metal containers regardless of the liquid's flash point.

Testing of metal containers with plastic plugs have been shown to prevent the violent rupture of the container. The plastic plug, if properly designed, will vent due to an increase in internal pressure and temperature and prevent container failure. However, if the container is not properly cooled with water from sprinklers, the container will produce a flame jet which will expose other containers and result in an out of control fire. The plastic plugs need to be proven to perform as expected in a fire. FM Approved fusible closures have been shown to provide the needed venting in a fire.

3.5.5 Protection of Plastic, Composite (Plastic-Metal), or Other Combustible Containers: General

Proven protection schemes for liquid-packaging combinations that are tied only to Table 2.4.5.1 are not currently available. The recommended protection will not prevent the consumption of all of the liquid stored in the cutoff room or building, but it may prevent structural failure of the roof and walls by cooling the structures. For large containers, the quantity of liquid in a single container greatly increases the potential for a spill fire that will activate all of the sprinklers in the cutoff room or building. The addition of a foam-water sprinkler system has not been shown to improve any of the protection line items tied only to Table 2.4.5.1.

3.6 Operation and Maintenance

Thorough basic equipment and building maintenance programs are fundamental components of any ignitable liquid storage facility. Such programs contribute to reducing the potential for a fire, as well as reducing the frequency and severity of such events.

3.7 Training

Thorough employee training is a fundamental component of any ignitable liquid storage facility. Such training contributes to reducing the potential for a fire, as well as reducing the frequency and severity of such events. Proper employee training for spill response and lift truck operation can help ensure that a small fire is contained and does not escalate into a major loss.

3.8 Ignition Source Control

A basic design goal for occupancies that contain ignitable liquids is the elimination and careful control of all potential ignition sources. Prevention measures should prevent contact of an ignition source with any flammable vapor-air mixture.

Unlike solid materials, liquids with low flash points do not require much energy to ignite since they produce flammable vapor at ambient temperatures. Preventing the ignition of an accidentally released ignitable liquid prevents an ignitable liquid fire. The most common ignition sources in a warehouse are electrical equipment, fork lift trucks, employees, and hot work operations. Storage of liquids with excess vaporization rates (i.e., boiling point below 100°F [38°C]) should have added precautions taken to prevent an ignition of a spill. Since liquid vapor is heavier than air, using hazardous area rated electrical equipment or not allowing electrical equipment within 6 ft (1.8 m) of the floor would provide the needed level of ignition source control where the flammable vapor will likely be located. Careless operation of fork lift trucks creates an opportunity for an accidental release of liquid. Use of a properly rated fork lift truck would ensure the needed level of ignition control is available where the most likely source of flammable vapor generation is expected.

Control of open ignition sources such as matches, fired heating equipment, and hot work must be strictly controlled in and around areas storing ignitable liquids. Any open flame or spark has ample energy to ignite flammable vapor released by ignitable liquids. Since the vapor is heavier than air, it has the ability to flow away from the point of release. Hot work or an open flame well away from a liquid spill can ignite the spill if the vapor flows to the work area.

4.0 REFERENCES

4.1 FM Global

Data Sheet 1-10, *Interaction of Sprinklers, Smoke and Heat Vents and Draft Curtains*
Data Sheet 1-21, *Fire Resistance of Building Assemblies*
Data Sheet 1-29, *Roof Deck Securement and Above-Deck Roofing Components*
Data Sheet 2-0, *Installation Guidelines for Automatic Sprinklers*
Data Sheet 4-0, *Special Protection Systems*
Data Sheet 4-1N, *Fixed Water Spray Systems for Fire Protection*
Data Sheet 4-7N, *Low Expansion Foam Systems*
Data Sheet 4-12, *Foam-Water Sprinkler Systems*
Data Sheet 5-8, *Static Electricity*
Data Sheet 5-10, *Protective Grounding for Electric Power Systems and Equipment*
Data Sheet 5-11, *Lightning and Surge Protection for Electrical Systems*
Data Sheet 5-48, *Automatic Fire Detection*
Data Sheet 7-31, *Storage of Aerosol Products*
Data Sheet 7-32, *Ignitable Liquid Operations*
Data Sheet 7-50, *Compressed Gases in Portable Cylinders*
Data Sheet 7-53, *Liquefied Natural Gas (LNG)*
Data Sheet 7-55, *Liquefied Petroleum Gas (LPG) in Stationary Installations*
Data Sheet 7-83, *Drainage and Containment Systems for Ignitable Liquids*
Data Sheet 7-88, *Outdoor Ignitable Liquid Storage Tanks*
Data Sheet 7-96, *Printing Plants*
Data Sheet 8-1, *Commodity Classification*
Data Sheet 8-9, *Storage of Class 1, 2, 3, 4 and Plastic Commodities*
Data Sheet 9-0/17-0, *Asset Integrity*
Data Sheet 10-0, *The Human Factor of Property Conservation*
Data Sheet 10-3, *Hot Work Management*

Approval Guide, an online resource of FM Approvals

4.2 NFPA

National Fire Protection Association (NFPA). NFPA 13, *Standard for the Installation of Sprinkler Systems*.
National Fire Protection Association (NFPA). NFPA 30, *Flammable and Combustible Liquids Code*.
National Fire Protection Association (NFPA). NFPA 70, *National Electrical Code*.

4.3 Other

American Society of Mechanical Engineers (ASME). *Pipe Threads, General Purpose*. B1.20.1.

ASTM International. *Standard Test Methods for Fire Tests of Building Construction and Materials*. ASTM E119.

ASTM International. *Standard Test Method for Flash Point by Tag Closed Tester*. ASTM D56.

ASTM International. *Standard Test Methods for Flash Point by Pensky-Martens Closed Cup Tester*. ASTM D93.

International Organization for Standardization (ISO). *Pipe threads where pressure-tight joints are not made on the threads - Part 1*. ISO 228-1.

International Organization for Standardization (ISO). *Determination of Flash Point - Pensky-Martens Closed Cup Method*. ISO 2719.

APPENDIX A GLOSSARY OF TERMS

Cartoned storage: Containers of liquid packaged in at least a single layer of corrugated cardboard are considered cartoned storage for the purposes of this data sheet. The cardboard packaging must at least cover the bottom and two full sides of the unit. The other two sides must be at least 80% covered. The top can be open.

Compressed air foam (CAF) system: A CAF system consists of a piping system separate from the sprinkler system, an air supply, a foam concentrate supply, a water supply, a mixing system, a detection system and a control panel. To use these systems for liquid protection, they will use the same concentrate as a foam-water sprinkler system. A major advantage to this type of system is they use significantly less foam concentrate to produce very high quality foam. Testing has shown that the delivered foam is very resistant to sprinkler discharge breaking up the blanket.

Emulsion: An emulsion is a stable mixture of two or more immiscible liquids held in suspension by small percentages of substances called emulsifiers.

Fire control: Limiting the size of a fire by distribution of water so as to decrease the heat release rate and pre-wet adjacent combustibles while controlling ceiling gas temperatures to avoid structural damage.

Fire extinguishment: The combustion process is completely stopped. As stated below in "fire suppression", water-only ceiling sprinklers cannot extinguish a fire in liquids with a low flash point. A special protection system, such as foam-water sprinkler system, may be able to extinguish ignitable liquid fires.

Fire point: The lowest temperature at which a liquid in an open container will give off enough vapor to ignite and continue to burn. Fire points are generally slightly higher than the open-cup flash point for a particular liquid. Liquids can have flash points without having fire points. A liquid without a fire point will not burn (e.g., 15% ethanol-water solution: closed-cup flash point 107°F [42°C], no fire point; 15% acetone-water solution: closed-cup flash point 49°F [9°C], no fire point).

Fire suppression: Sharply reducing the heat release rate of a fire and preventing its regrowth by means of direct and sufficient application of water through the fire plume to the burning fuel surface. This term does not mean the fire is completely extinguished. To date (2020), ceiling sprinkler technology cannot extinguish a low flash point liquid pool fire with water alone. Sprinklers can achieve many of the elements that define a suppressed fire (i.e., break up the fire plume, significantly reduce the heat release rate, and reduce ceiling temperatures). However, once the protection is shut down, if fuel is still present, the fire will quickly grow back to its original size. A fire involving low flash point liquids cannot be truly suppressed by water-based fire protection. A very high level of control is possible and, if maintained until the fuel is consumed, the fire will be extinguished.

Flash point: The minimum temperature at which sufficient vapor is liberated to form a vapor-air mixture that will ignite and propagate a flame away from the ignition source (flash fire, not continuous combustion). Evaporation will take place below the flash point, but the quantity of vapor released is not sufficient to produce an ignitable vapor-air mixture. A flash point can be determined by using either a closed-cup or open-cup test apparatus. The closed-cup test will produce lower flash points than open-cup tests because it provides greater vapor containment (i.e., increases vapor accumulation). The closed-cup flash point is used to classify

liquids because it is conservative (i.e., produces lowest flash point for liquid), and it represents the conditions in which most liquids are handled (i.e., most liquids are contained in closed containers or equipment).

FM Approved: Product and services that have satisfied the criteria for FM Approval. Refer to the *Approval Guide*, an online resource of FM Approvals, for a complete list of products and services that are FM Approved.

Foam-water sprinkler system: A foam-water sprinkler system consists of a closed or open head sprinkler system that is connected to a low expansion foam concentrate proportioning system designed to deliver a fixed foam concentration. The major advantage to installing a foam system is they can be added to an existing sprinkler system. Closed and open head foam-water sprinkler systems are described in Data Sheet 4-12, *Foam-Water Sprinkler Systems*.

General purpose warehouse: A warehouse used to store general commodities such as plastics or Class 3 commodities. A general purpose warehouse does not require emergency drainage, containment, rated electrical equipment, or ventilation.

Heat of combustion: The amount of heat released when a unit quantity of fuel is oxidized completely to yield stable end products. The measurement is generally made in an oxygen bomb calorimeter. A similar term is the "chemical heat of combustion," which represents the amount of heat released when a unit quantity of fuel is combusted in air. The chemical heat of combustion is less than the heat of combustion due to the inefficiency of the combustion process in air.

Heat release rate: The rate at which energy is released in a fire. The heat release rate is a function of the fuel's heat of combustion, mass loss rate, and the exposed surface area.

Ignitable liquid: Any liquid or liquid mixture that has a measurable flash point. The hazard of a liquid depends on its ability to sustain combustion or create a flammable vapor-air mixture above its surface. Flash point is one way of understanding if a liquid can create that flammable vapor-air mixture. For a liquid to burn in a pool, it must have a fire point as well as a flash point. Ignitable liquids include flammable liquids, combustible liquids, inflammable liquids, and any other term for a liquid that will burn.

Intermediate bulk container (IBC): Defined by the U.S. Department of Transportation in CFR Title 49, Part 178, Subpart N, dated October 1, 1997, and the United Nations Recommendations on the Transport of Dangerous Goods, Ninth Edition, Chapter 16. The container size is limited to 793 gal (3 m³). There are no other specific requirements on the design or material of construction. All IBCs must pass the required performance-based testing designed to evaluate their resistance to leakage during transport. No existing test requirements evaluate the container's performance when exposed to fire. The IBC category also includes the containers previously defined as portable tanks or tote tanks. Some limitations on the type of liquid storage allowed in an IBC used for transportation do exist. However, for most commonly transported ignitable liquids, there are few limitations.

In general, the maximum-size IBC used for liquid transport is approximately 660 gal (2.5 m³) due to overall package weight. More common sizes range from 250 to 330 gal (0.95 to 1.3 m³). Common IBC construction types include all-plastic self-supporting containers; plastic-supported plastic containers (plastic composite containers that consist of a rigid plastic frame supporting a plastic container); and metal-supported plastic containers (metal-plastic composite containers that consists of a metal frame supporting a plastic container). Since the only evaluation IBCs need to pass is performance-based testing, there is very little consistency in the design of IBCs produced by various manufacturers. A series of fire tests sponsored by the manufacturers clearly showed that the fire performance of a particular type of IBC could not be generalized. This is likely due to the variability of the designs.

Composite IBC: IBCs consisting of a blow-molded plastic bottle enclosed within a steel cage.

Plastic IBC: IBC with a plastic bottle surrounded by a plastic frame.

Bag-in-box IBC: IBC consisting of a plastic bag inside a corrugated box.

Liquid: A material that does not have a defined shape at room temperature unless it is stored in a container. These materials flow freely when released. (e.g., water, honey, heptane).

Non-ignitable liquid: A liquid that does not burn or exhibit a flash point.

Open area fraction: The amount of open space between and around barrels in plan view, taking account of flue spaces but not aisles, as shown in Figure A.1.

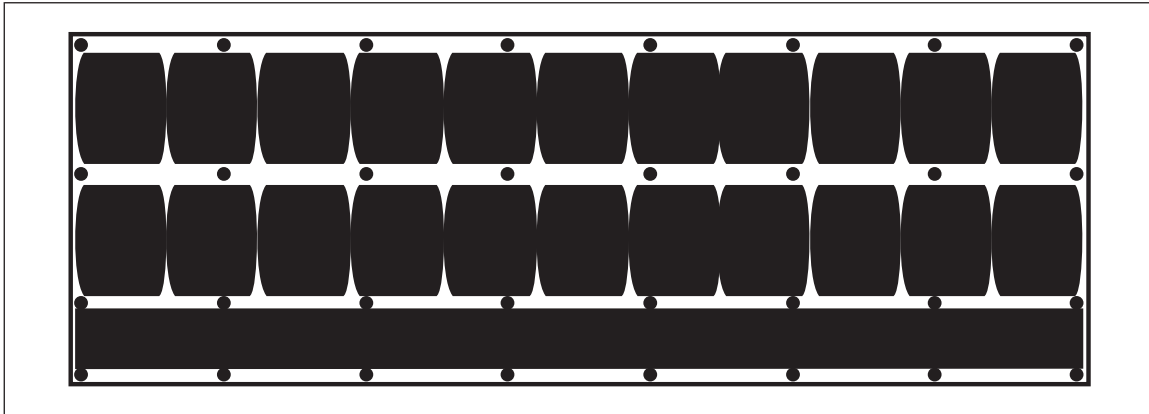

Fig. A.1. Plan view (white area represents open area fraction)

Prefabricated ignitable liquid storage building (PILSB): A structure designed to provide a safe, secure storage area with secondary containment for chemicals and hazardous waste materials. These units allow personnel entry. They are designed for the indoor and outdoor storage and dispensing of ignitable liquids. FM Approved storage buildings are of noncombustible construction, and some are of fire-rated construction. Additional details are provided in the *Approval Guide*.

Relieving-style container: A relieving-style container will release excess internal pressure without a significant release of the stored liquid when exposed to a fire. The pressure relief prevents the violent rupture of the container. It is also critical that the pressure relief does not allow significant liquid release. At this point in time (2011), only metal portable tanks (now included in the general container category of IBCs) are specifically listed or FM Approved to vent under fire exposure. The determination for all other container types is qualitative.

1. Some examples of relieving-style containers are:

- A metal 55 gal (230 L) drum fitted with plastic plugs in both the 2 in. (5.1 cm) and 3/4 in. (1.9 cm) openings in the top of the drum. Testing by FM Global and others using nylon and polyethylene fusible closures has shown that the fusible closure will fail when exposed to a fire and prevent a significant pressure buildup in the drum as well as maintain the overall drum integrity. Full-scale fire tests on metal drums filled with heptane and fitted with plastic fusible closures has shown that the relieving action will allow for greater palletized storage heights.
- A metal 5 gal (25 L) tight head pail (i.e., top and bottom are permanently attached to sides) with plastic pour spout. Most tight head 5 gal (25 L) containers are relieving-style. Testing has shown that the plastic pour spout will melt and allow the container to vent and prevent the full release of the stored liquid.
- A metal 5 gal (25 L) lug head pail (i.e., top is held in place by friction and lug tabs on cover, similar to a large paint can) with plastic pour spout. Same performance as the tight head container.
- A metal 1 gal (4 L) F-style (rectangular) can with either a plastic spout or a soldered metal spout. Both spout arrangements will fail in a fire and allow internal pressure to vent while preventing the release of the liquid.
- A metal 1 gal (4 L) friction lid can (e.g., circular paint cans). The friction lid will pop off when exposed to fire. In many cases, the lid will only move slightly, allowing pressure relief without significant liquid release. In some cases the lids move away from the container, allowing liquid to spray out during the release and sprinkler water to enter the can and displace the stored liquid. The small can size minimizes this negative performance.
- Metal IBCs that meet DOT/UN rules.

2. Some examples of non-relieving-style containers or containers that are not acceptable as relieving-style are:

- A metal 55 gal (230 L) drum fitted with metal plugs in both the 2 in. (5.1 cm) and 3/4 in. (1.9 cm) openings in the top of the drum. This container will not release internal pressure early in a fire. The end result of a sealed drum exposed to fire is the violent failure of the container.
- A metal 55 gal (230 L) drum fitted with a plastic plug in an opening located in the side of the drum or a plastic container of any size. Both container types will vent any pressure buildup; however, they will also release the stored liquid.
- A metal 5 gal (25 L) tight head pail (i.e., top and bottom are permanently attached to sides) with metal caps over opening. This container will not vent pressure buildup early in a fire.
- A metal 5 gal (25 L) lug head pail (i.e., top is held in place by friction and lug tabs on cover, similar to a large paint can) with metal caps over the opening. The top of this type of container will vent pressure buildup similar to the 1 gal (4 L) paint can. However, the lid tends to release at a higher pressure and the venting of the lid results in a large quantity of liquid release. Also, once open, sprinkler water will enter the container and displace the stored liquid. The quick response sprinkler-based fire protection scheme for metal containers could fail to control the fire if several 5 gal (25 L) containers release their contents.
- A metal 1 gal (4 L) F-style (rectangular) can with crimped-on metal spout. These containers have failed violently during full-scale fire tests.

Semi-solid: A material that has a defined shape at room temperature without containment, but can be forced to flow with pressure. (e.g., butter, paste ink, gels).

Solid: A material that has a defined shape at room temperature and cannot be forced to flow with pressure. (e.g., wood, plastic, glass, wax). Materials with a melting point above 150°F [66°C], can be treated as a solid.

Specific gravity: The ratio of the weight of a substance to the weight of the same volume of another substance. The specific gravity for ignitable liquids is provided using water as a basis. Specific gravities less than 1 indicate the liquid is lighter than, and will float on top of, water. Conversely, specific gravities greater than 1 indicate the liquid will sink in water. This information permits a determination of what effect water will have on an ignitable liquid fire. Liquids heavier than water will sink, indicating water would extinguish a fire involving this liquid (cover liquid and smother fire). Liquids lighter than water will float, indicating the fire would not be extinguished but could be spread by water if adequate drainage is not provided.

Stable liquid: A liquid that does not self-react or polymerize.

Storage lockers for ignitable liquids: A storage unit for various size ignitable liquid containers that does not allow personnel to enter the structure. These lockers are FM Approved for outdoor use only.

Uncartoned storage: Containers of liquid that are arranged on pallets without cardboard boxes are considered uncartoned storage for the purposes of this data sheet. This type of storage usually consists of containers arranged on trays or sheets layered on a pallet and held in place with shrink-wrapping. Uncartoned storage also applies to any storage that does not meet the definition of cartoned storage.

Unstable liquid: A liquid that, in its pure state or as commercially produced or transported, will vigorously polymerize, decompose, undergo condensation reaction, or become self-reactive under condition of shock, pressure, or temperature.

Vapor density: The weight of a volume of pure vapor or gas (with no air present) compared to the weight of an equal volume of dry air at the same temperature and pressure. It is calculated as the ratio of the molecular weight of the gas to the average molecular weight of air, 29. A vapor density figure less than 1 indicates the vapor is lighter than air. A figure greater than 1 indicates the vapor is heavier than air. Ignitable liquids produce vapor that is heavier than air. The vapor will collect at floor level and exhibit fluid properties (i.e., it will flow to low points and accumulate). Flammable vapor, if not removed by ventilation, can flow to an ignition source and flash back to the vapor source.

Wall construction categories:

Combustible: A wall made of any combustible material, any metal-faced plastic-insulated sandwich panels that are not FM Approved, and any wall with single-pane annealed (not tempered) glass windows.

Noncombustible: Materials include FM Approved Class 1 insulated, steel or aluminum-faced sandwich panels with thermoset plastic insulation; exterior insulation and finish system (EIFS) assemblies having noncombustible insulation and gypsum board sheathing; and aluminum or steel panels that are uninsulated

or insulated with noncombustible insulation such as glass fiber, mineral wool, or expanded glass. It also includes cementitious panels or shingles over steel or wood. Any windows should be multi-pane or tempered glass.

Fire-rated: The wall should meet the required fire rating per FM Global Data Sheet 1-21, *Fire Resistance of Building Assemblies*. Any openings should be protected with a comparably fire-rated door. Any windows should be fire-rated to match the rating of the wall.

Water-miscible: A water-miscible liquid mixes in all proportions with water. When water-miscible ignitable liquids are mixed with water, a homogeneous solution is formed. The flash point, fire point, heat of combustion, and heat release rate of the solution will be different from the pure ignitable liquid. The flash point and fire point of the solution will increase as the water concentration increases. At a certain water concentration (which varies for different ignitable liquids), the fire point will no longer exist and the solution will no longer present a fire hazard (e.g., 15% ethyl alcohol in water, 15% acetone in water).

APPENDIX B DOCUMENT REVISION HISTORY

October 2020. This document has been completely revised. Major changes include the following:

- A. Revised the definition of "ignitable liquid" to be consistent with Data Sheet 7-32, *Ignitable Liquid Operations*.
- B. Provided a definition for very high flash point liquids (in the atypical liquids section) to replace the previous guidance for liquids with a flash point at or above 450°F (232°C). As part of this change, the flash point threshold has been lowered to 414°F (212°C).
- C. Added guidance for the storage and protection of FM Approved composite intermediate bulk containers.
- D. Revised figure (Fig. 2.2.1.1) and table (Table 2.2.1.1) for location and construction of ignitable liquid storage areas.
- E. Clarified the intent of drainage and containment (Section 2.2.2 and Tables 2.2.2.1.A and 2.2.2.1.B).
- F. Clarified guidance for FM Approved prefabricated ignitable liquids storage buildings (PILSBs) and storage lockers (Section 2.2.3).
- G. Revised ventilation recommendations. Ventilation is now only required for storage occupancies containing liquids with a boiling point below 100°F (38°C), storage occupancies with poorly maintained and leaking containers, and storage occupancies with dispensing operations (Section 2.3.2).
- H. Added guidance on flue spaces (Section 2.3.3) that is aligned with Data Sheet 8-9.
- I. Added a new section to consolidate guidance on in-rack sprinklers (Section 2.4.1.5).
- J. Added protection guidance for rack storage of metal drums where the roof height exceeds 30 ft (9.1 m) (Sections 2.4.3.1.1 and 2.4.4.1.1).
- K. Revised the options for rack storage protection for any flash point, uncartoned, small metal containers (6.5 gal [25 L] or less) based on fire testing (Table 2.4.4.1.A). Face sprinklers are now recommended for double-row and multiple-row rack storage.
- L. Added guidance for shelf storage of ignitable liquids in plastic or glass containers (Section 2.4.5.2).
- M. Added protection for propylene glycol and ethylene glycol in composite IBCs (Table 2.4.6.1) and plastic drums (Table 2.4.7.3.2).
- N. Added protection criteria for rack and palletized storage of distilled spirits in wooden barrels (Sections 2.4.8 and 2.4.9).
- O. Revised electrical equipment ratings (Table 2.8.1).
- P. Clarified guidance on when balancing is recommended with Scheme A (Section D.2.2.1).
- Q. Added more figures for protection options (e.g., for single-row racks) and revised other figures to provide consistency.
- R. Renumbered tables and figures based on section numbers.

April 2020. Interim revision. Minor editorial changes were made.

January 2018. Interim revision. Lowered the flashpoint threshold of very high flashpoint liquids from 500°F (260°C) to 450°F (232°C).

July 2014. Interim revision. The following changes were made:

A. Added new protection options for palletized storage of Group 3 water-miscible liquid in 59 oz (1.75 L) glass or plastic bottles for the following storage and roof height combinations:

- 17 ft (5.2 m) (max) of storage in a 30 ft (9 m) building
- 17 ft (5.2 m) (max) of storage in a 40 ft (12 m) building
- 5 ft (1.5 m) of storage in a 40 ft (12 m) building

B. Added a new protection option for rack storage of Group 3 water-miscible liquid in 59 oz (1.75 L) glass or plastic bottles that does not use a solid barrier and is stored to unlimited heights in unlimited-height buildings.

C. Added a new protection option for rack storage of Group 1 water-miscible liquid in 60 gal (230 L) plastic drums for storage heights up to 30 ft (9 m) in 45 ft (13.7 m) high buildings.

April 2012. Minor editorial changes were done for this revision.

January 2012. The following changes were made for this revision:

A. Replaced references to "flammable" and "combustible" liquids with "ignitable" liquids throughout the document.

B. Modified formatting, changed rearranged tables, and eliminated inconsistencies as follows:

1. Rearranged the document to align with the current data sheet format.
2. Renumbered, edited, and reformatted all tables to improve consistency, clarity, and alignment with the pressure/number of sprinklers approach in Data Sheet 8-9.
3. Added definitions of liquid, solid, semi-solid, stable liquid, and unstable liquid.
4. Moved semi-solid liquid evaluation criteria from Data Sheet 8-1 to this document and simplified the criteria.
5. Clearly stated that ignitable liquid storage cannot be mixed with flammable gas or oxidizers.

C. Revised location and construction as follows:

1. Eliminated space separation figures for outdoor storage and aligned the approach with Data Sheet 7-88 and Data Sheet 1-22 criteria.
2. Revised the drainage and containment table to include all liquids and containers covered by this data sheet (now Tables 3a and 3b).
3. Revised/clarified the drainage and containment recommendations to simplify the criteria, identify reduced criteria for liquids with a specific gravity greater than one, and add containment requirements for high flash point liquids and alcohol in composite IBCs protected in accordance with Table 13.
4. Created a single location table for all liquids and containers covered by this data sheet.
5. Included compressed air foam (CAF) protection systems as an option for lack of emergency drainage, and eliminated gaseous special protection systems as an option.
6. Added more guidance on the use and location of FM Approved ignitable liquids cabinets.
7. Added an allowance for locating an FM Approved prefabricated ignitable liquid storage buildings (PILSBs) within a building.

D. Revised protection options as follows:

1. Provided an evaluation of the fire hazard created by specific liquids such as glycols, silicone fluids and silicone-water emulsions, PMDI/Polyol, butterfat, and unsaturated polyester resins.

2. Based on the results of recent fire tests, added guidance for protecting liquids with flash points at or above 500°F (260°C) in containers larger than 40 gal (150 L). Included guidance for composite and bag-in-box IBCs.
3. Added new protection criteria for 3-high palletized empty composite IBCs with plastic, wood, or steel pallets.
4. Reworded the recommendation for storing empty containers. (NOTE: There is no technical change from the previous standard. The recommendation was simply rewritten to make it easier to understand.)
5. Removed the allowance for storing high flash point liquids in larger containers in general purpose warehouses because providing drainage is not considered practical.
6. Revised in-rack sprinkler design criteria to be based on a flow instead of a pressure. Also included the use of larger orifice sprinklers, which will allow for lower in-rack sprinkler discharge pressures. A minimum discharge pressure of 10 psi (0.7 bar) has been defined.
7. Provided protection criteria for high flash point ($\geq 200^\circ\text{F}$ [93°C]) liquids and alcohols in composite IBCs in racks.
8. Changed all ceiling sprinkler recommendations to provide a K11.2 (K160) or larger sprinkler in accordance with the requirements of NFPA 13, *Standard for the Installation of Sprinkler Systems*.
9. Added an option for protecting multiple-row rack storage of steel drums.
10. Revised protection criteria in Table 4 (previously Table 6) for two-high palletized metal IBCs containing liquids with a flash point at or above 200°F (93°C).
11. Based on the results of full-scale fire tests, eliminated standard response protection criteria for palletized storage of uncartoned small metal containers (6.5 gal [25 L] or less) regardless of liquid type.
12. Added a new Table 5 for rack storage of metal IBCs.
13. Provided a protection option for small metal containers (6.5 gal [25 L] or less) using Scheme A.
14. Provided protection for rack storage of low flash point liquids in up to 1 gal (4 L) plastic containers.
15. Added protection criteria for liquids with a flash point below 200°F (93°C) in 0.5 oz (15 ml) and 2 oz (60 ml) plastic containers.
16. Added protection criteria for Group 1 water-miscible liquids in 6 oz (180 ml), 6.5 gal (25 L), and 60 gal (230 L) plastic containers.
17. Revised protection for palletized liquids with a flash point above 450°F (232°C) in Table 17 to better reflect full-scale fire testing:
 - a) Increased standard response sprinkler protection for 15 ft (4.6 m) high storage in a 30 ft (9.1 m) building for containers up to 6.5 gal (25 L).
 - b) Increased standard response protection for 5 ft (1.5 m) high storage in a 30 ft (9.1 m) building for containers up to 6.5 gal (25 L).
 - c) Added protection for 20 ft (6 m) high storage in a 30 ft (9.1 m) building for 1 gal (4 L) containers.
 - d) Added protection for 15 ft (4.6 m) high storage in a 30 ft (9.1 m) building for 48 oz (1.4 L) containers.
18. Added new protection for rack storage of cartoned cooking oils in 35 ft (11 m) high racks in a 40 ft (12 m) building.
19. Revised protection for palletized water-miscible liquids in Table 18:
 - a) Glass and plastic bottles are differentiated due to the very poor performance of glass.
 - b) Group 3 in glass bottles has been severely limited due to a lack of successful testing.
 - c) Group 4 protection has been modified. One option was removed (specific application sprinkler protection), and the protection for standard response sprinklers was increased and the sprinkler temperature was changed to ordinary.

20. Revised in-rack protection requirements for steel drum storage of liquids with a flash point greater than or equal to 200°F (93°C) to align with in-rack arrangements for lower flash point liquid storage.

21. Reduced the hose stream requirement to 250 gpm (950 L/min) for certain cases with Scheme A protection criteria.

September 2004. Metric values in figures for fire protection Scheme A were corrected.

May 2004. Eliminated the exclusion for plastic or glass bottles that are 2 oz (60 ml) or less in size. Recent full-scale fire tests have demonstrated that even small plastic or glass bottles that are filled with an ignitable liquid can produce a severe fire hazard. New protection criteria has been added in Table 16a.

September 2003. The following changes have been made for this revision:

1. Provided information on the FM Approved fusible plugs for relieving-style drums.
2. Revised the title of Table 8 to eliminate the lower container size limit of 6.5 gal (25 L). The protection criteria in this table can be applied to smaller containers.
3. Revised protection criteria in Table 10 for rack storage of small metal containers. Provided criteria for high temperature ceiling sprinklers.

September 2002. Fire protection tables have been revised to be consistent with the new sprinkler approval categories.

May 2000. This document has been reorganized to provide a consistent format. In addition to the reformatting the following technical changes have been made:

1. New fire protection for products with less than or equal to 50% water- miscible liquid have been added. All of the water-miscible liquid fire protection criteria for rack storage have been incorporated into two new tables.
2. Space separation distances between low value unprotected ignitable liquid buildings and main buildings has been clarified.
3. ELO sprinklers have been expanded to include all control mode, area density spray sprinklers with a K-factor greater than or equal to K11.2 (K160).
4. Clarified use of ignitable liquid storage cabinets in warehouse areas.

September 1999. Minor Technical Revisions

May 1999. The document represents a complete rewrite of this data sheet. All previous recommendations were re-evaluated. Significant changes in the fire protection recommendations have been incorporated. The recommended criteria better reflect recent test results and have eliminated a number of inconsistencies in the old criteria. Fire protection design drawings have been provided to help clarify recommendations. The majority of the fire protection criteria is provided in tabular format.

APPENDIX C NFPA STANDARD

The 2018 edition of NFPA 30, *Flammable and Combustible Liquids Code*, covers ignitable liquid storage, use, piping and tanks. The storage chapters (9, 10, 11, 12, 13, 14, 15, and 16) share many similarities with this data sheet. However, NFPA 30 specifies minimum storage quantities that do not require adequate fire protection. Unfortunately, the specified quantities are still sufficient to cause an uncontrolled fire.

APPENDIX D JOB AIDS

D.1 Abbreviations Used in Fire Protection Tables

QR = Quick response sprinkler

SR = Standard response sprinkler

NA = Not applicable

DRR = Double-row rack, ≤ 9 ft (2.7 m) wide

Ordinary = Nominal 165°F (74°C) temperature rating

High = Nominal 286°F (141°C) temperature rating

D.2 Fire Protection Illustrations

D.2.1 In-Rack Layouts

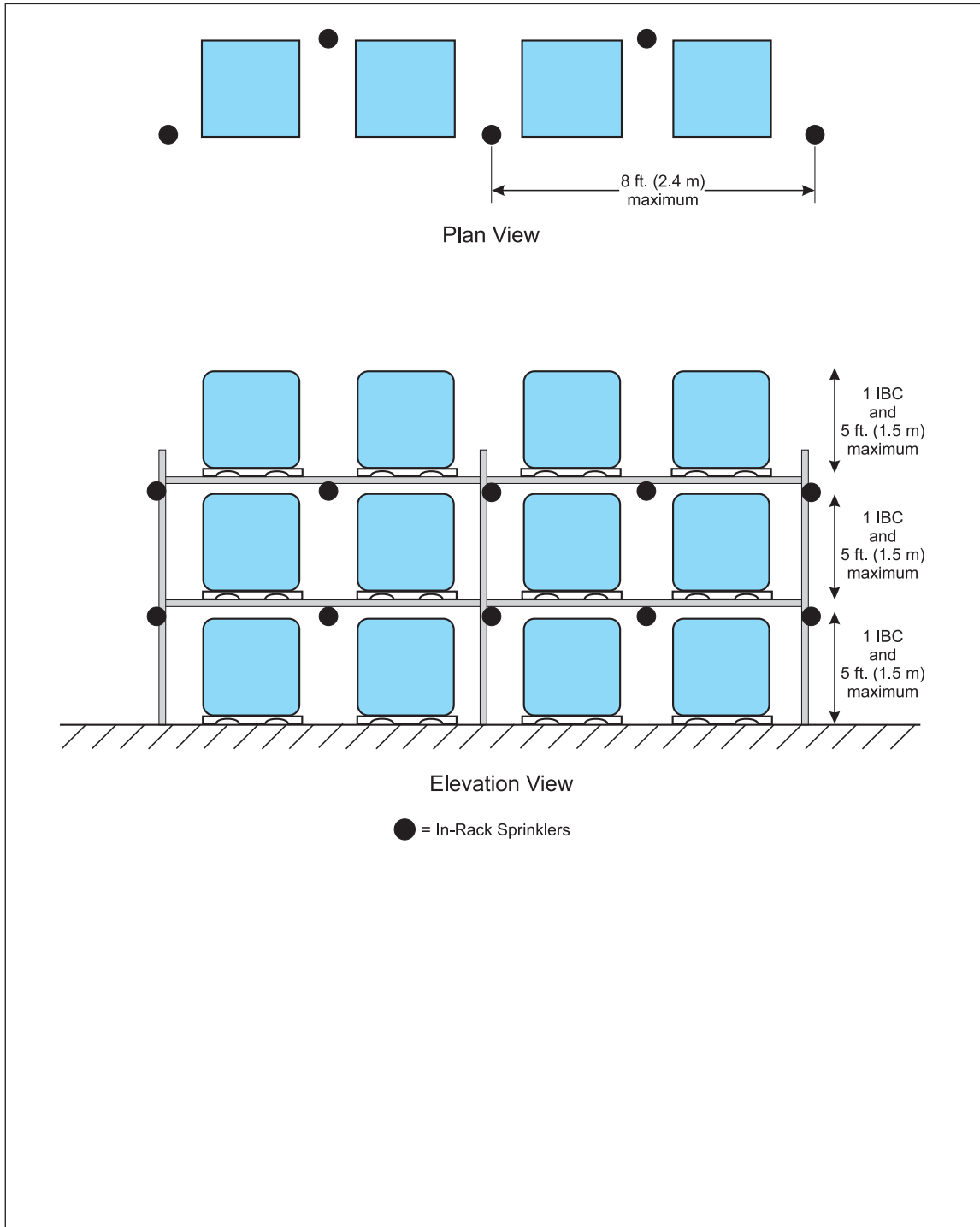

Fig. D.2.1.1. Single-row rack sprinkler layout: IBC protection scheme

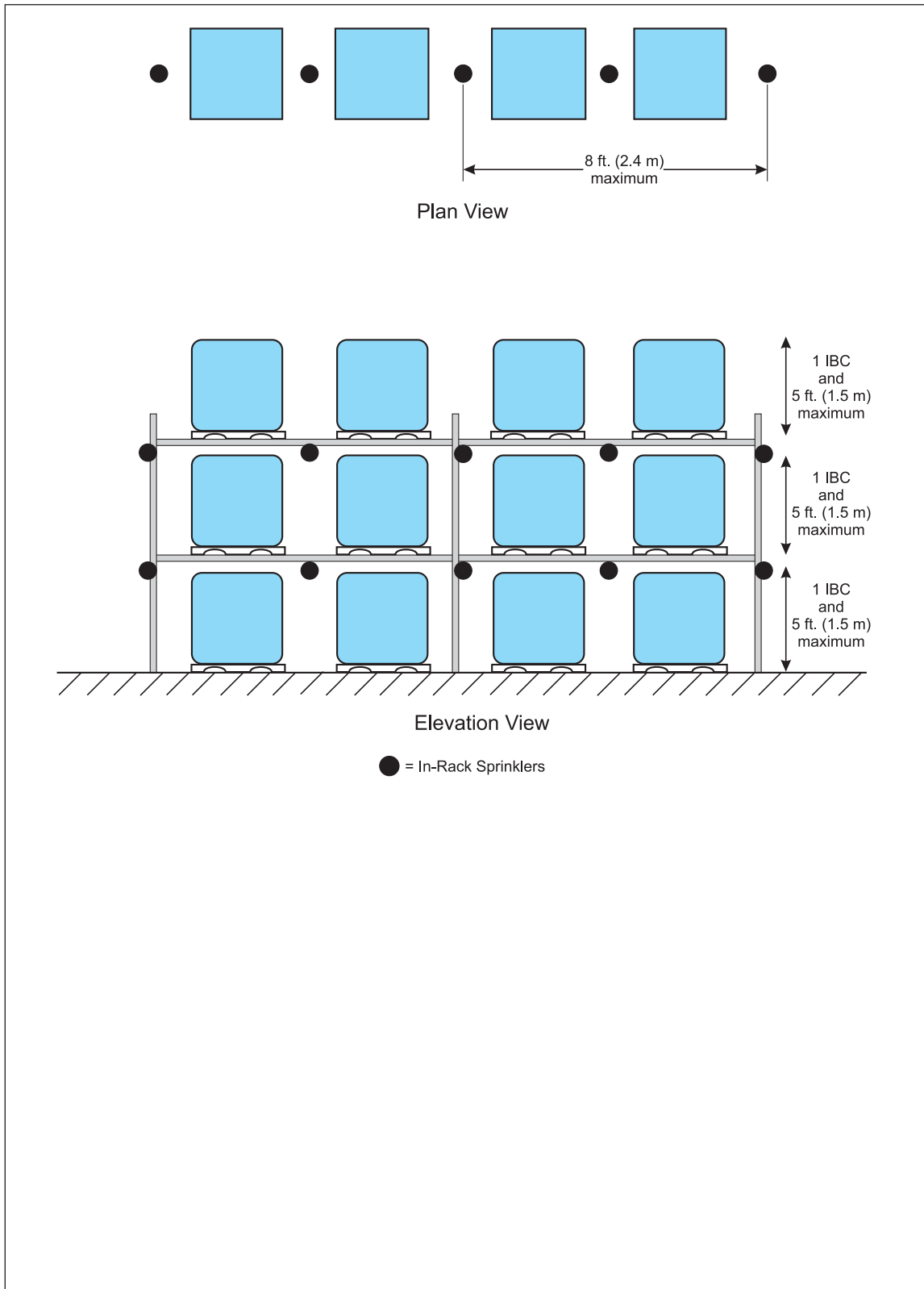

Fig. D.2.1.2. Single-row rack sprinkler layout: IBC protection scheme

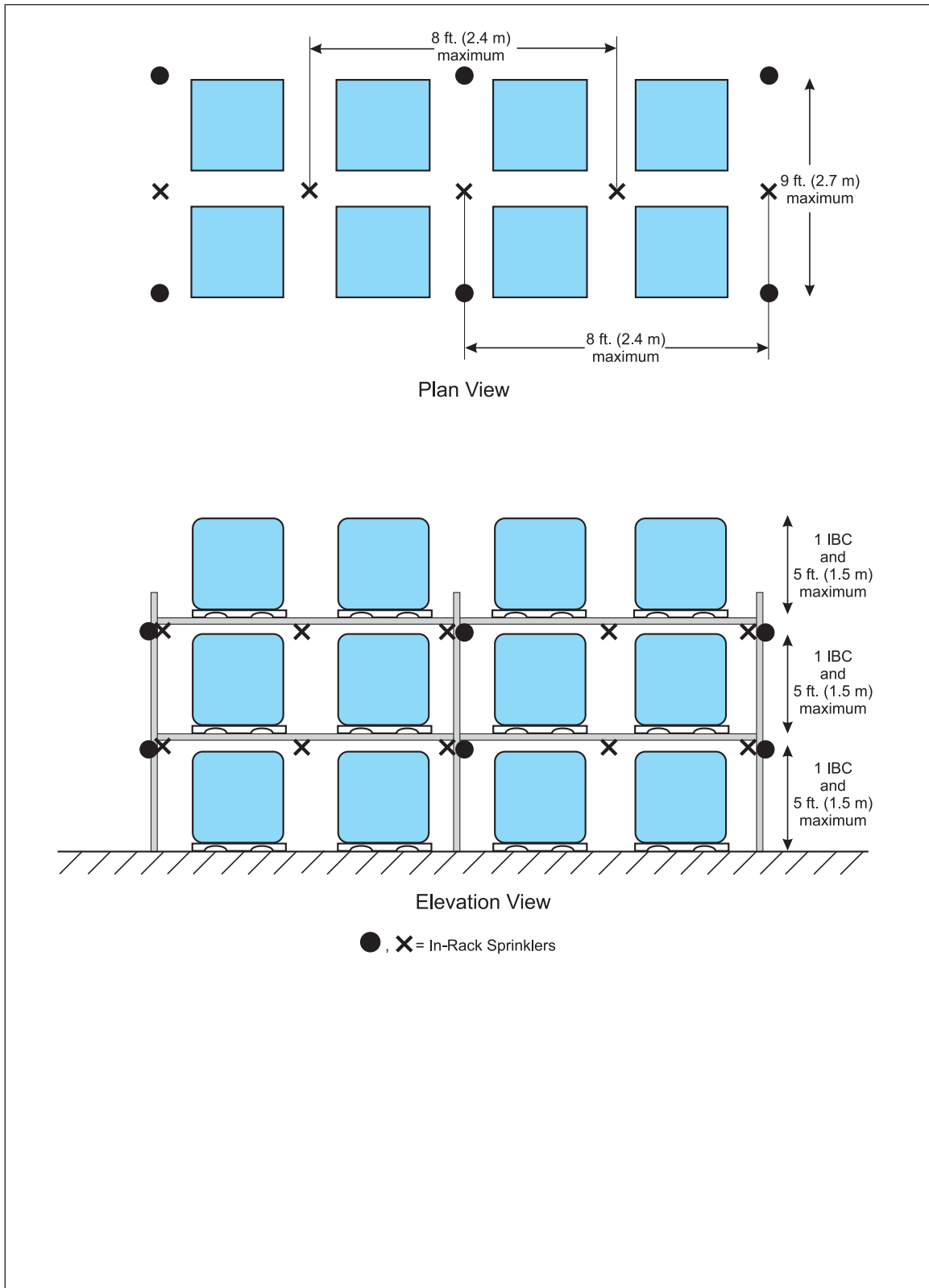

Fig. D.2.1.3. Double-row rack sprinkler layout: IBC protection scheme

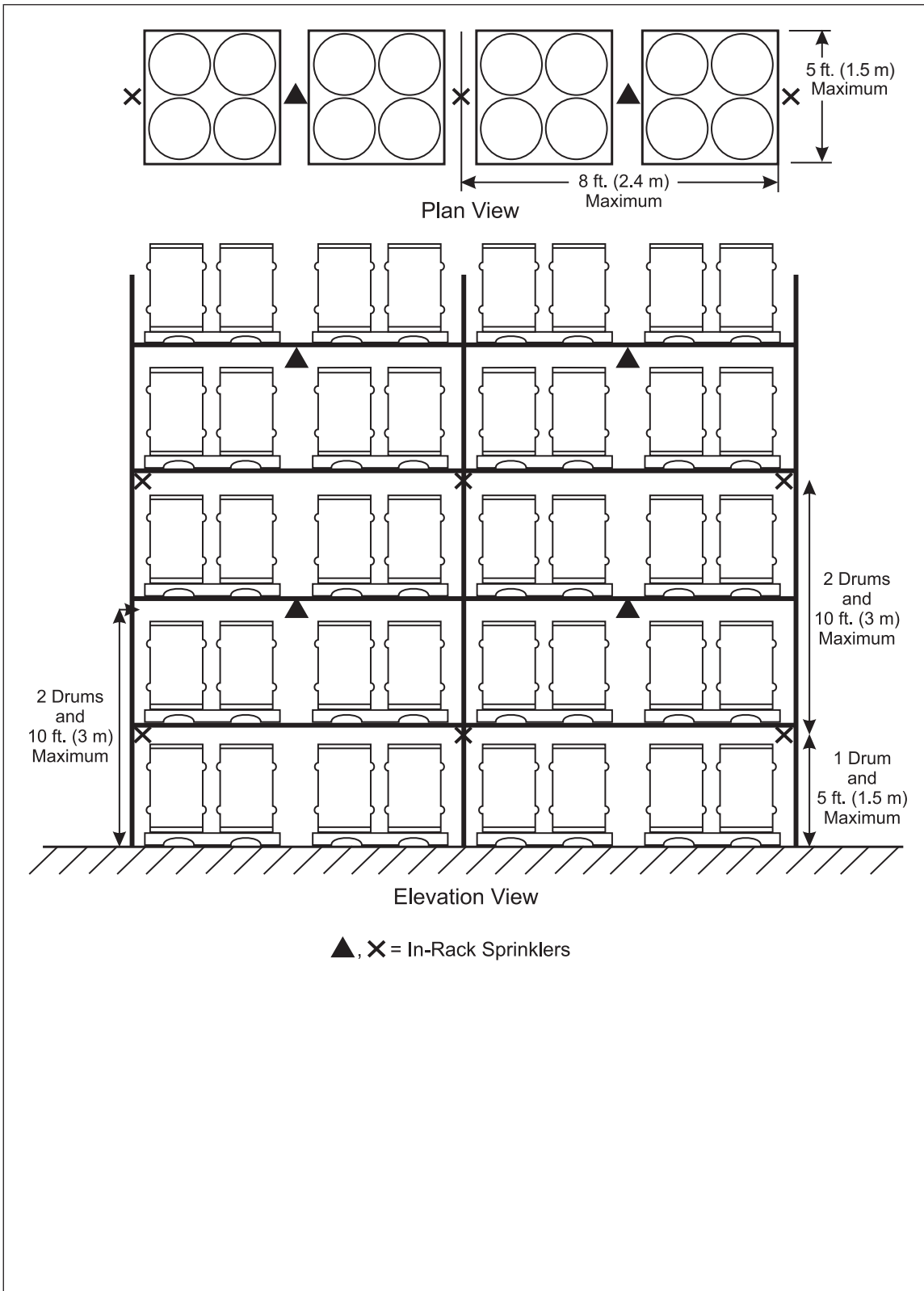

Fig. D.2.1.4. Single-row rack sprinkler layout: drum protection scheme

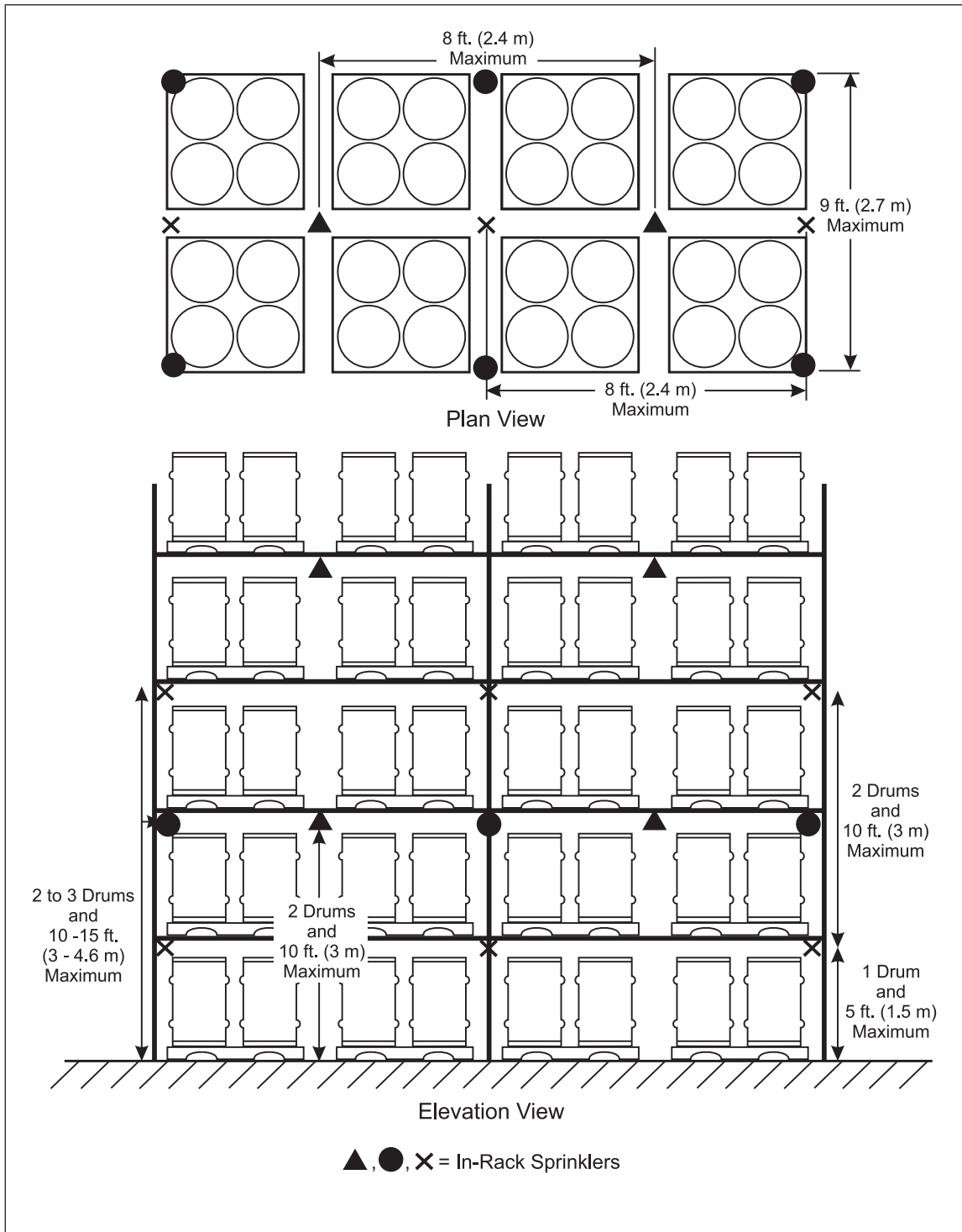

Fig. D.2.1.5. Double-row rack sprinkler layout: drum protection scheme

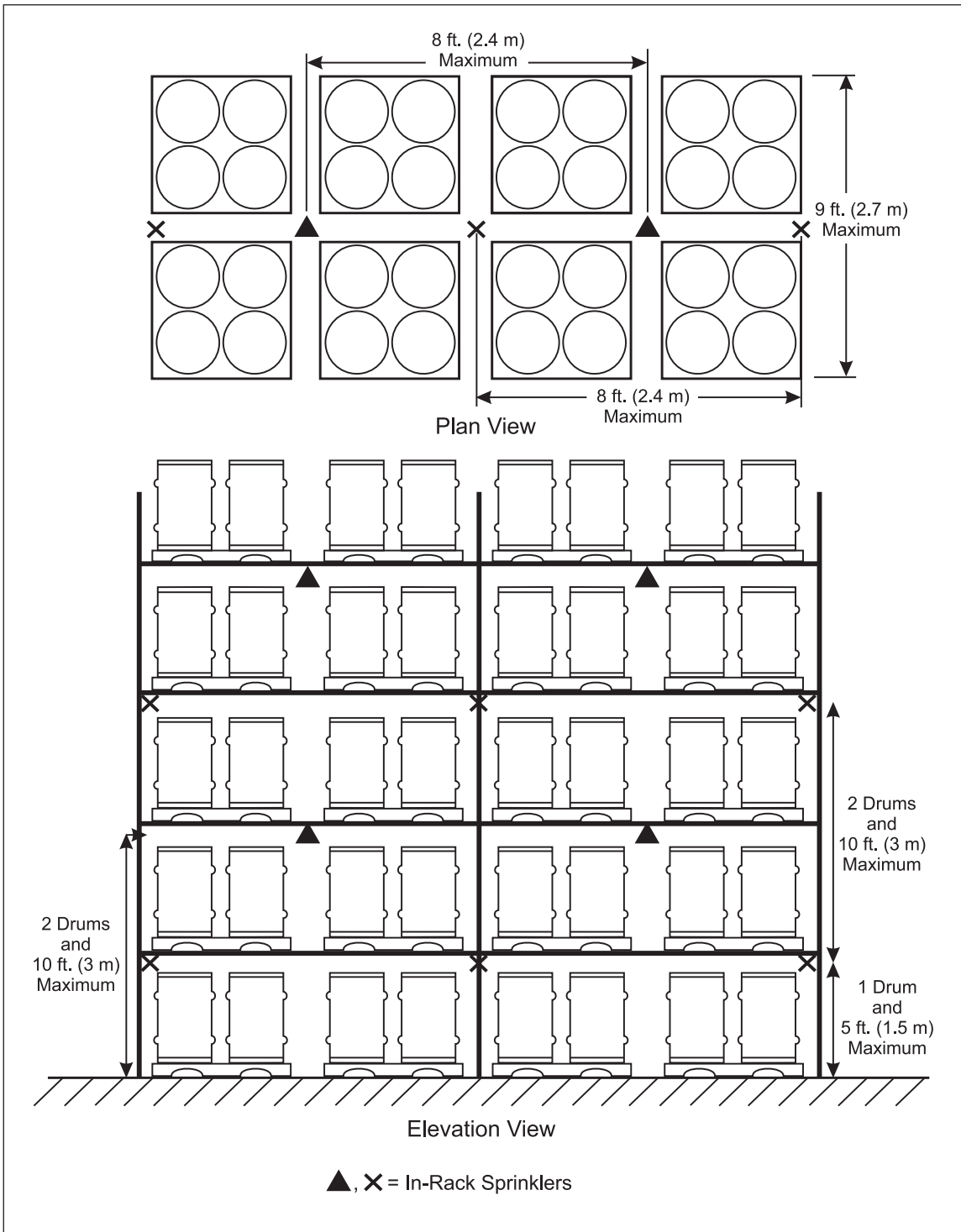

Fig. D.2.1.6. Double-row rack sprinkler layout: drum protection scheme

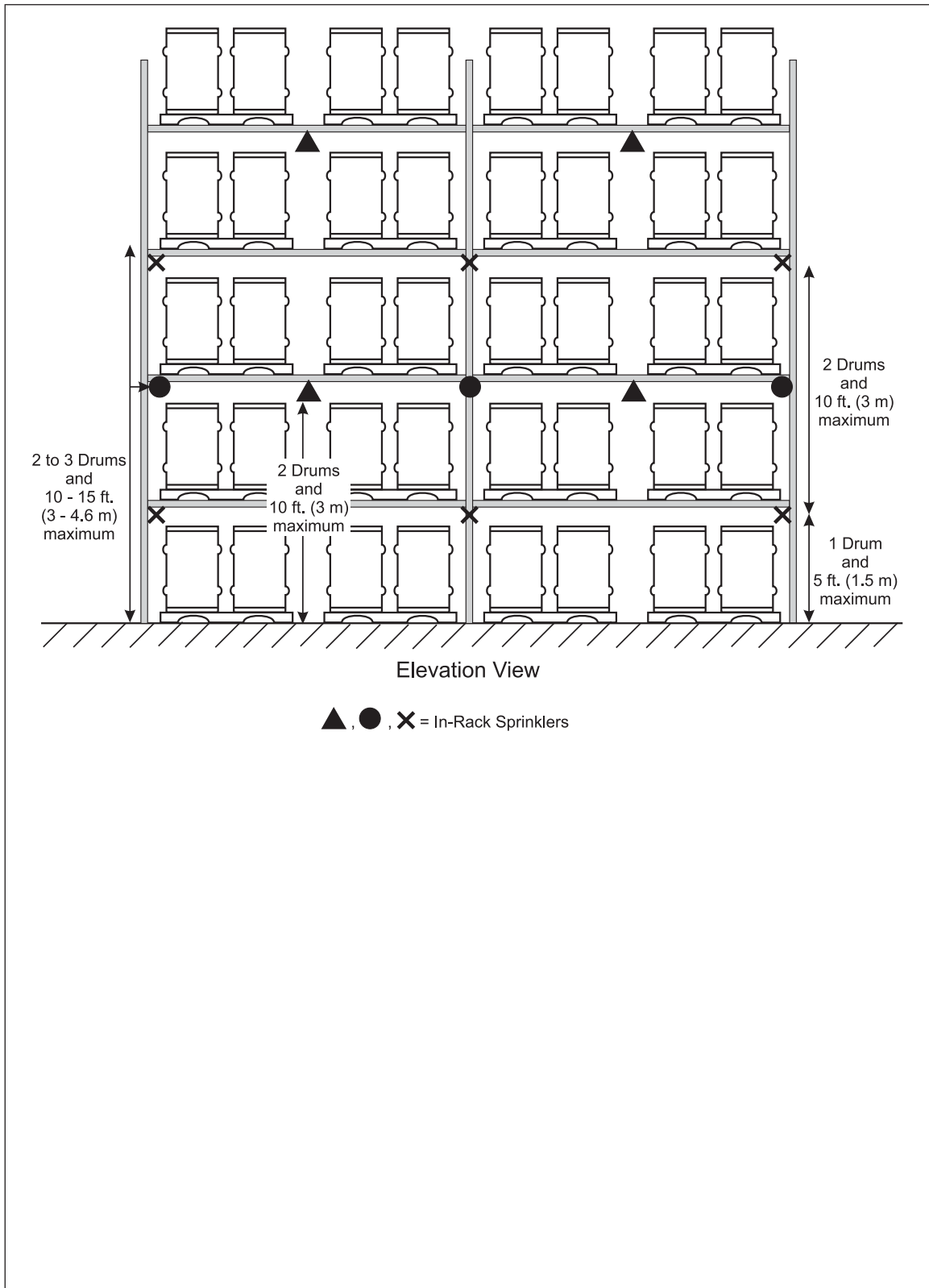

Fig. D.2.1.7. Multiple-row rack sprinkler layout: drum protection scheme (elevation view)

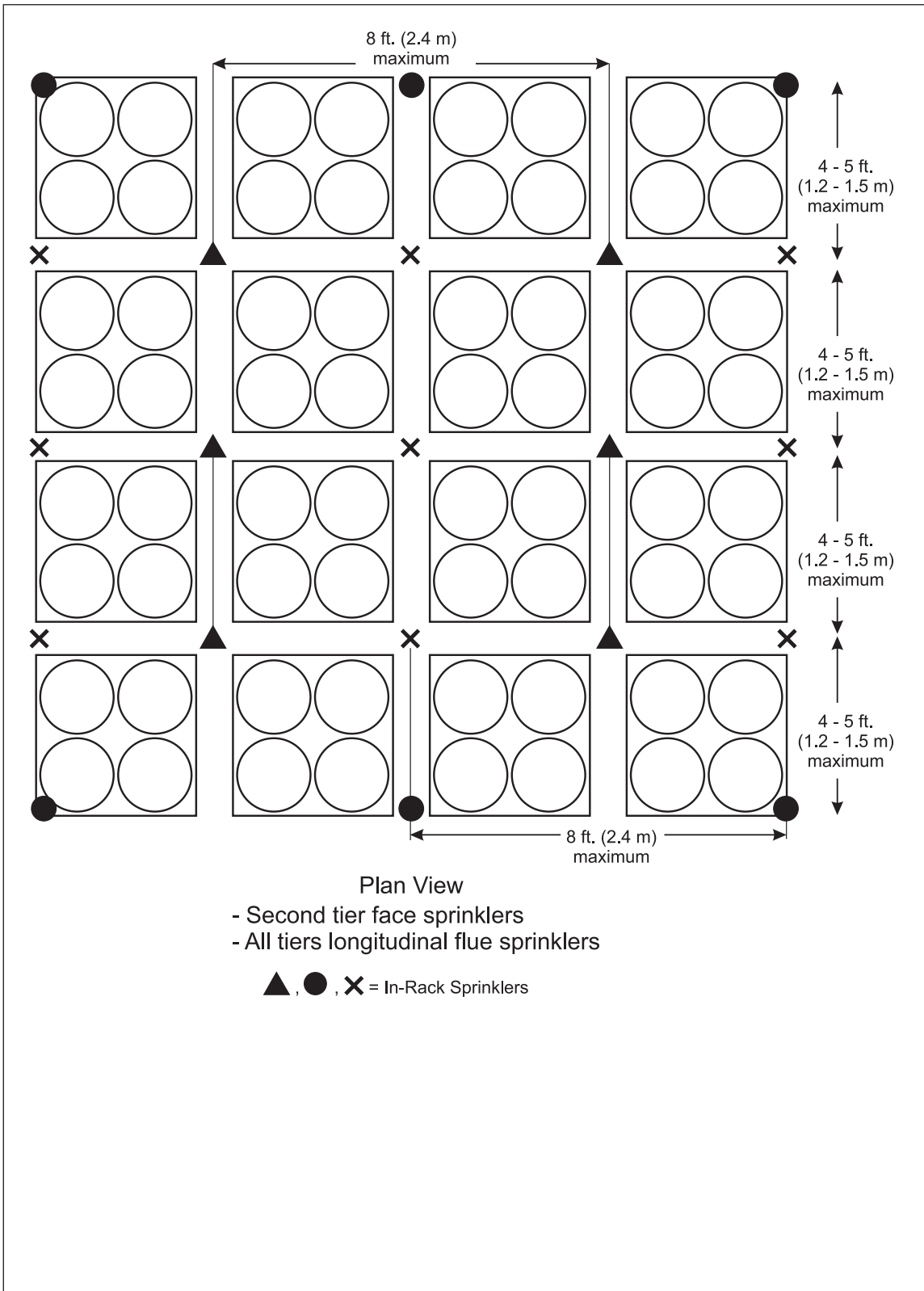

Fig. D.2.1.8. Multiple-row rack sprinkler layout: drum protection scheme (plan view)

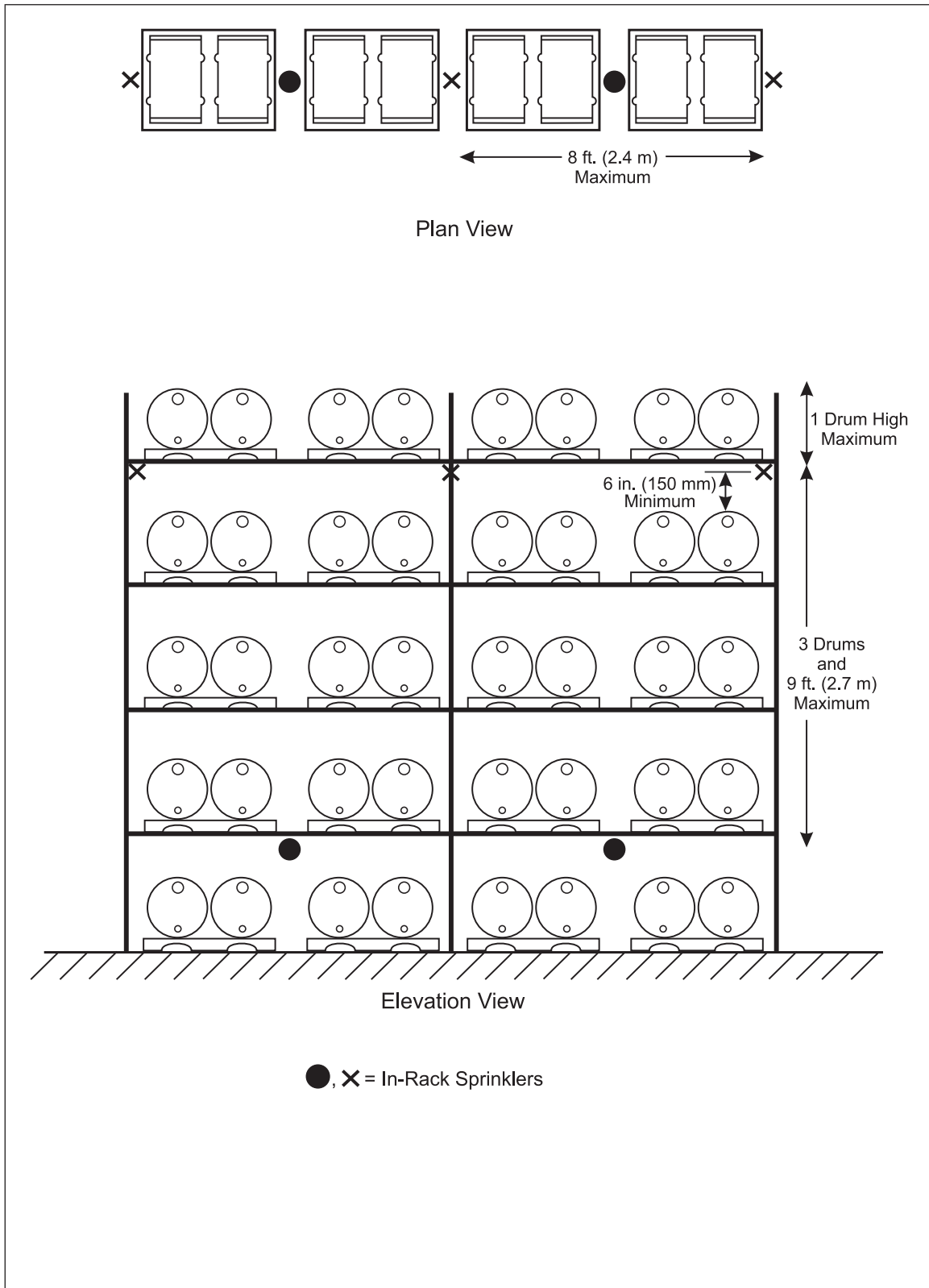

Fig. D.2.1.9 Single-row rack sprinkler layout: drum protection scheme

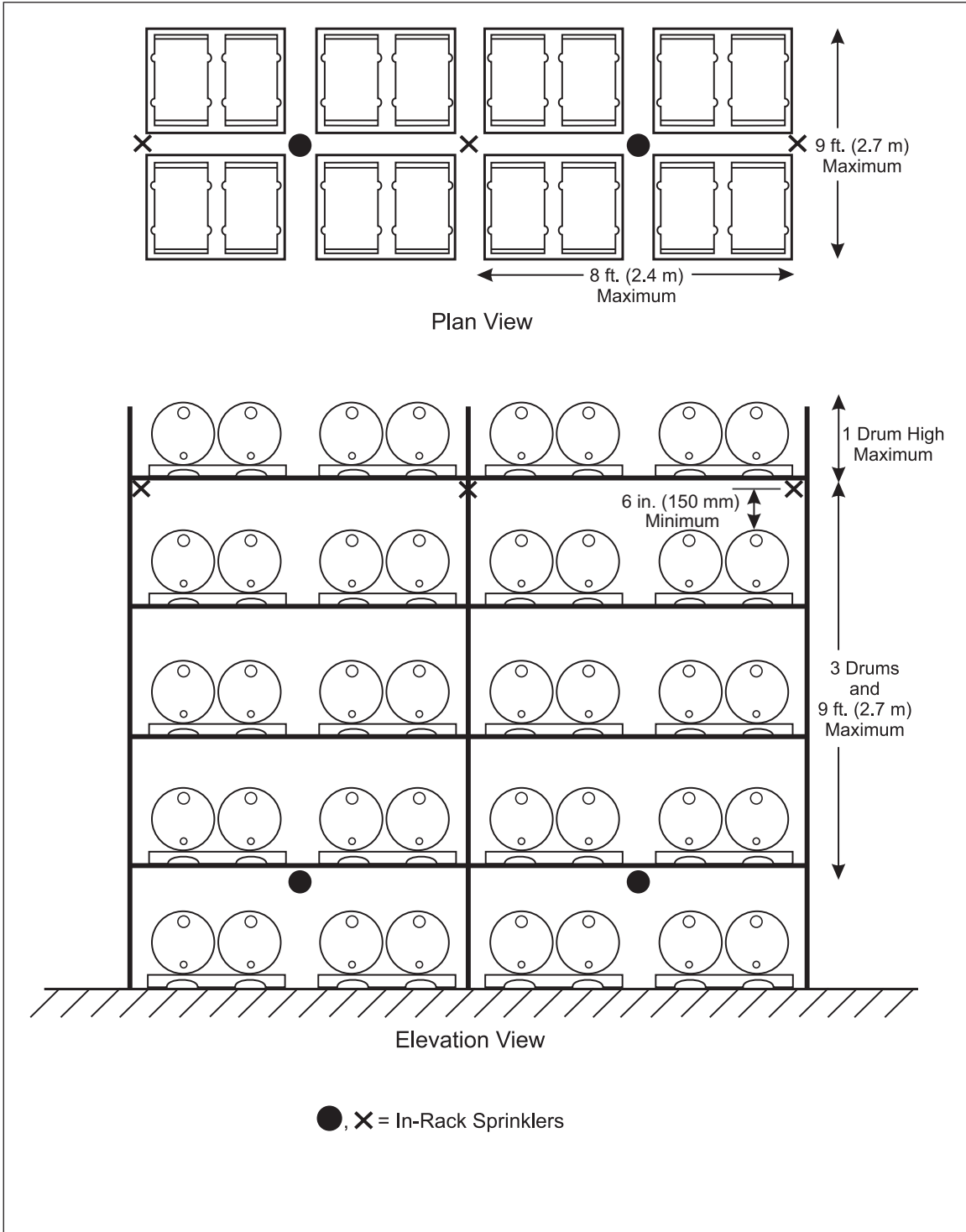

Fig. D.2.1.10. Double-row rack sprinkler layout: drum protection scheme

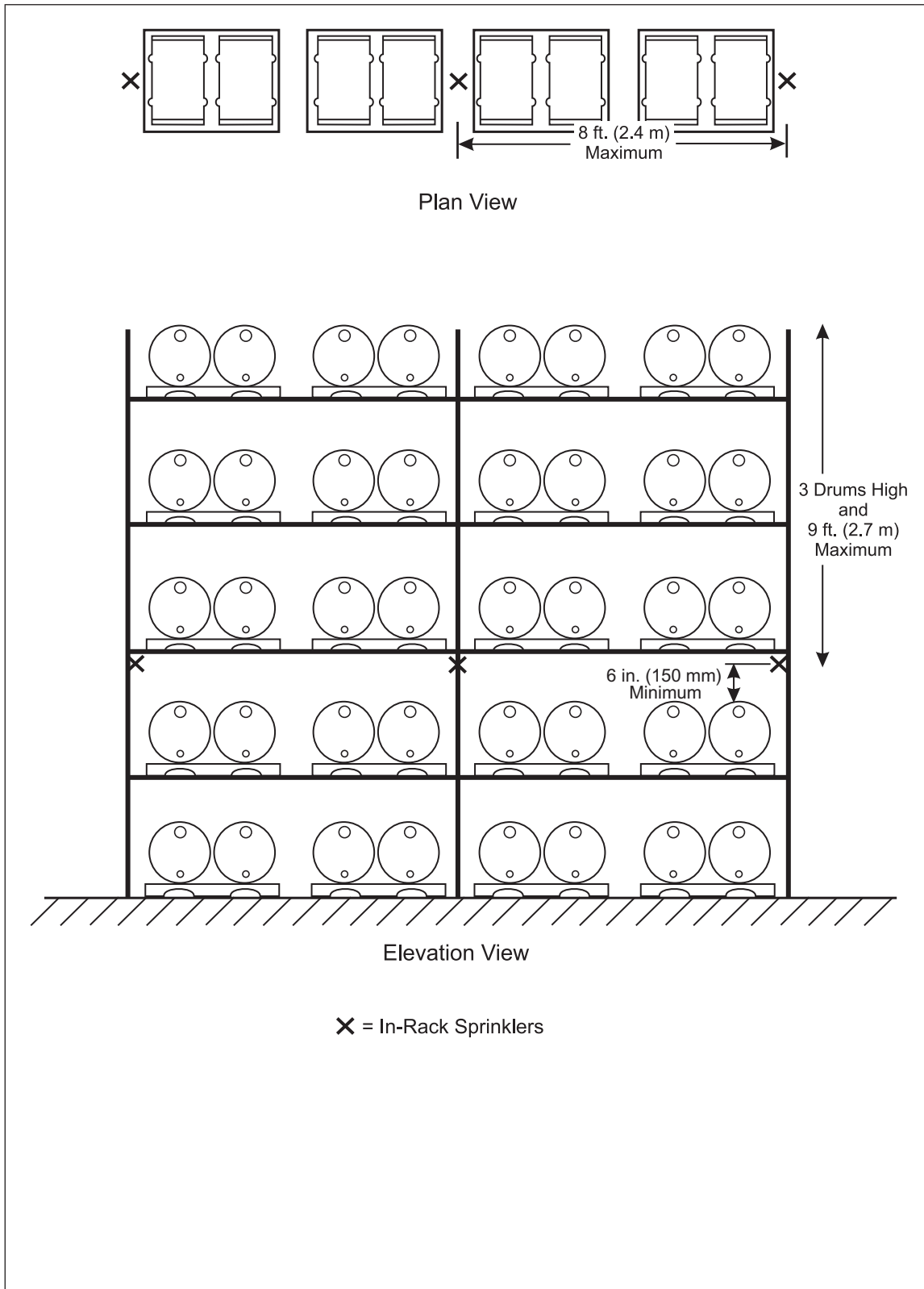

Fig. D.2.1.11. Single-row rack sprinkler layout: drum protection scheme

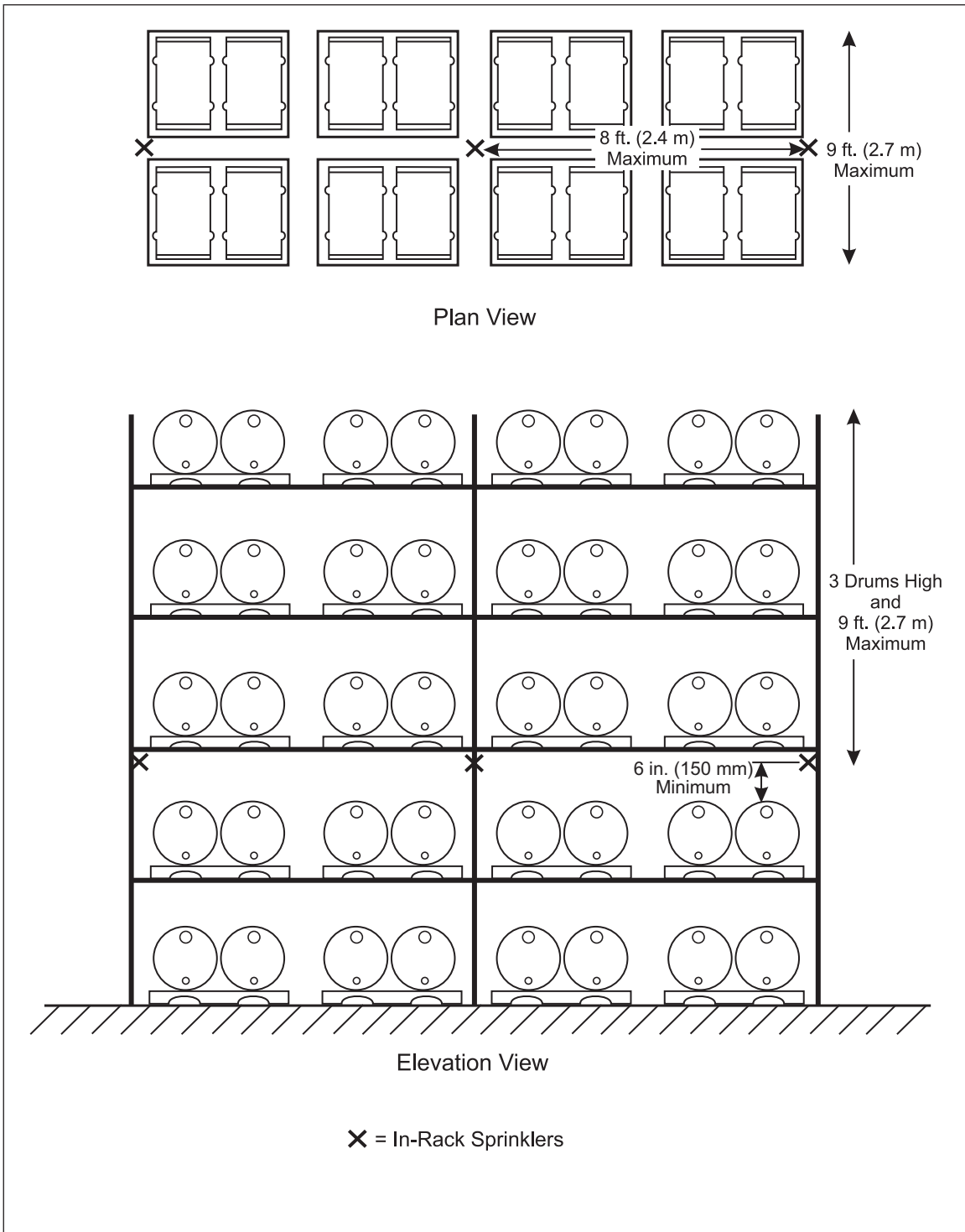

Fig. D.2.1.12. Double-row rack sprinkler layout: drum protection scheme

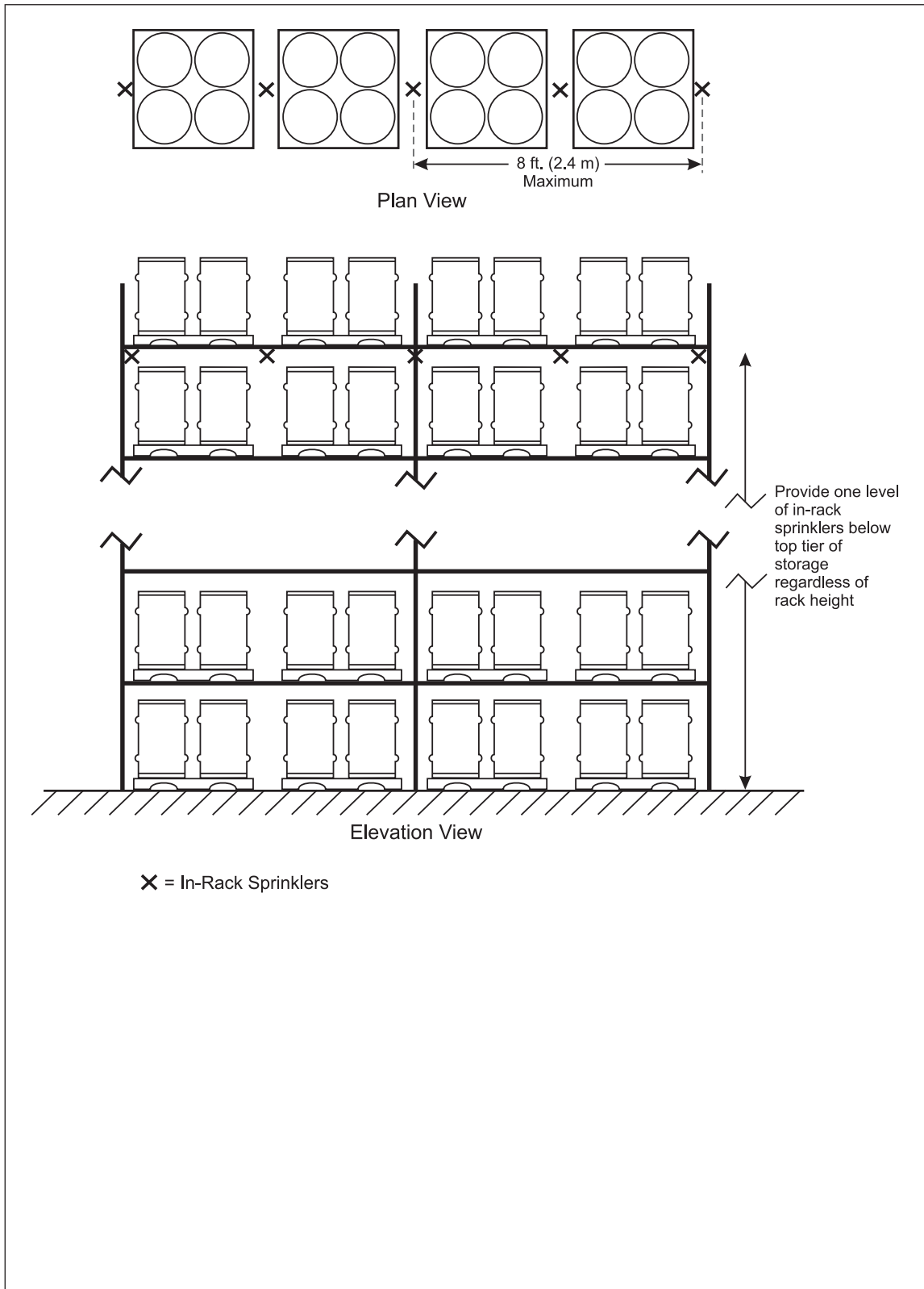

Fig. D.2.1.13. Single-row rack sprinkler layout: drum protection scheme

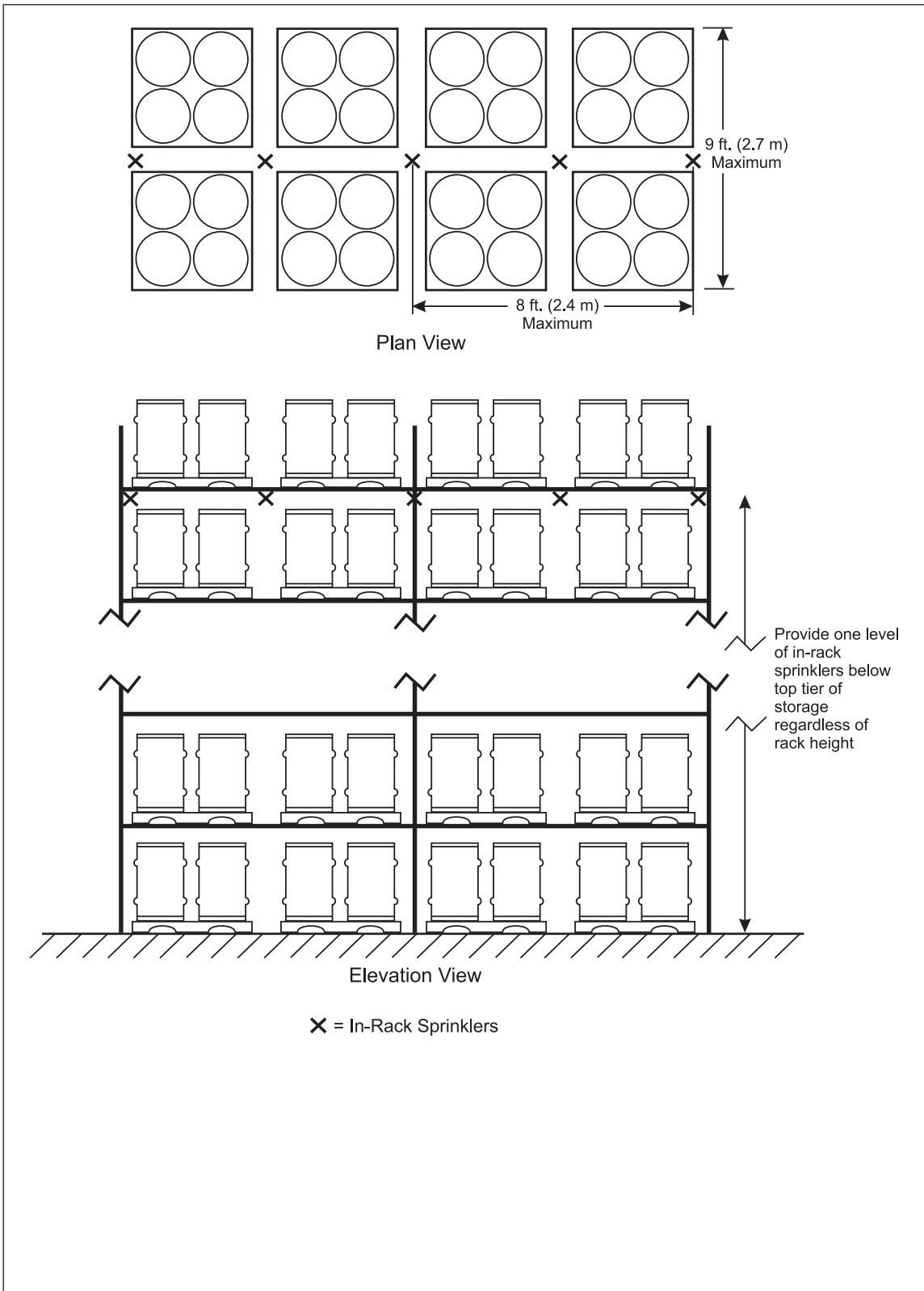

Fig. D.2.1.14. Double-row rack sprinkler layout: drum protection scheme

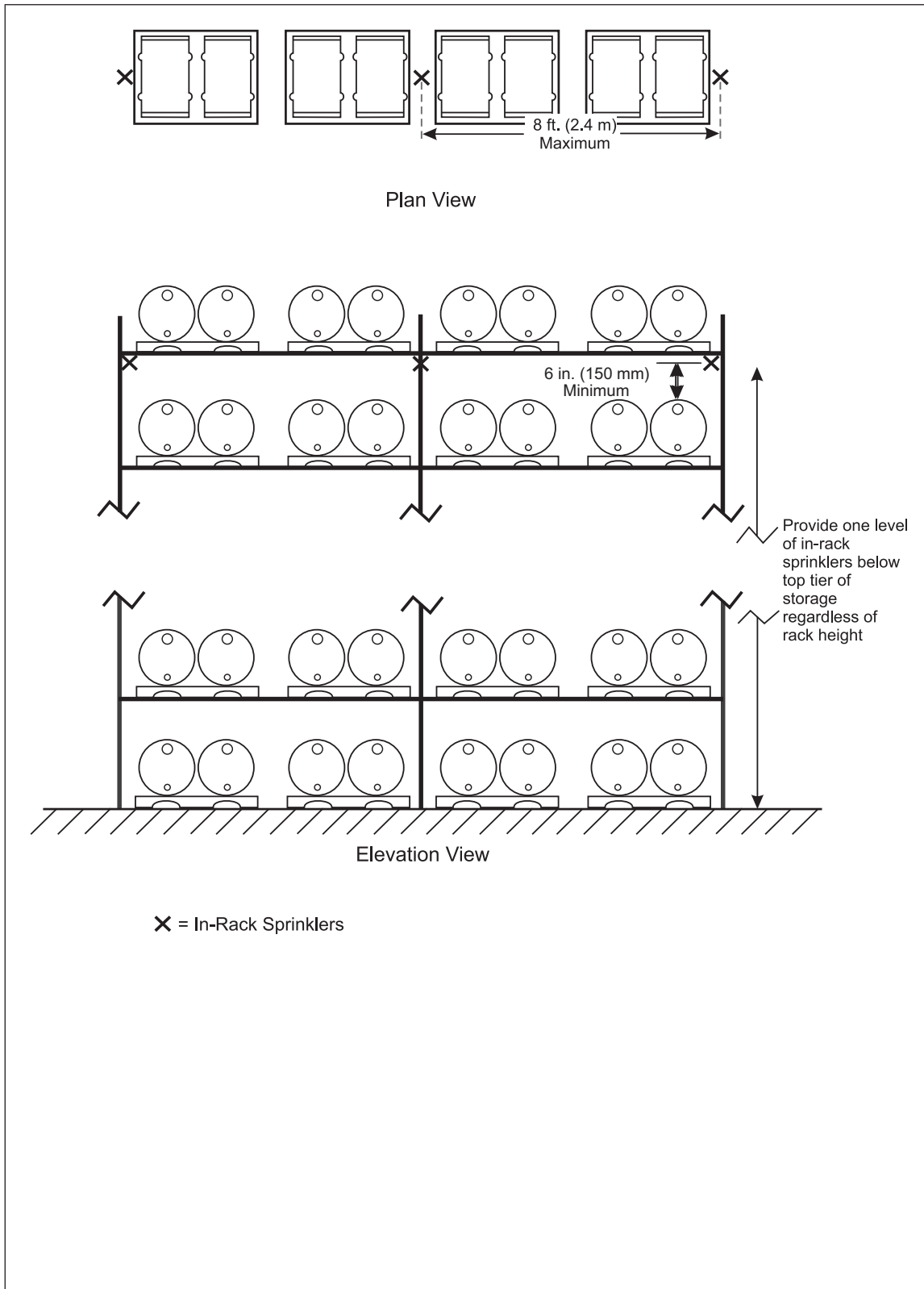

Fig. D.2.1.15. Single-row rack sprinkler layout: drum protection scheme

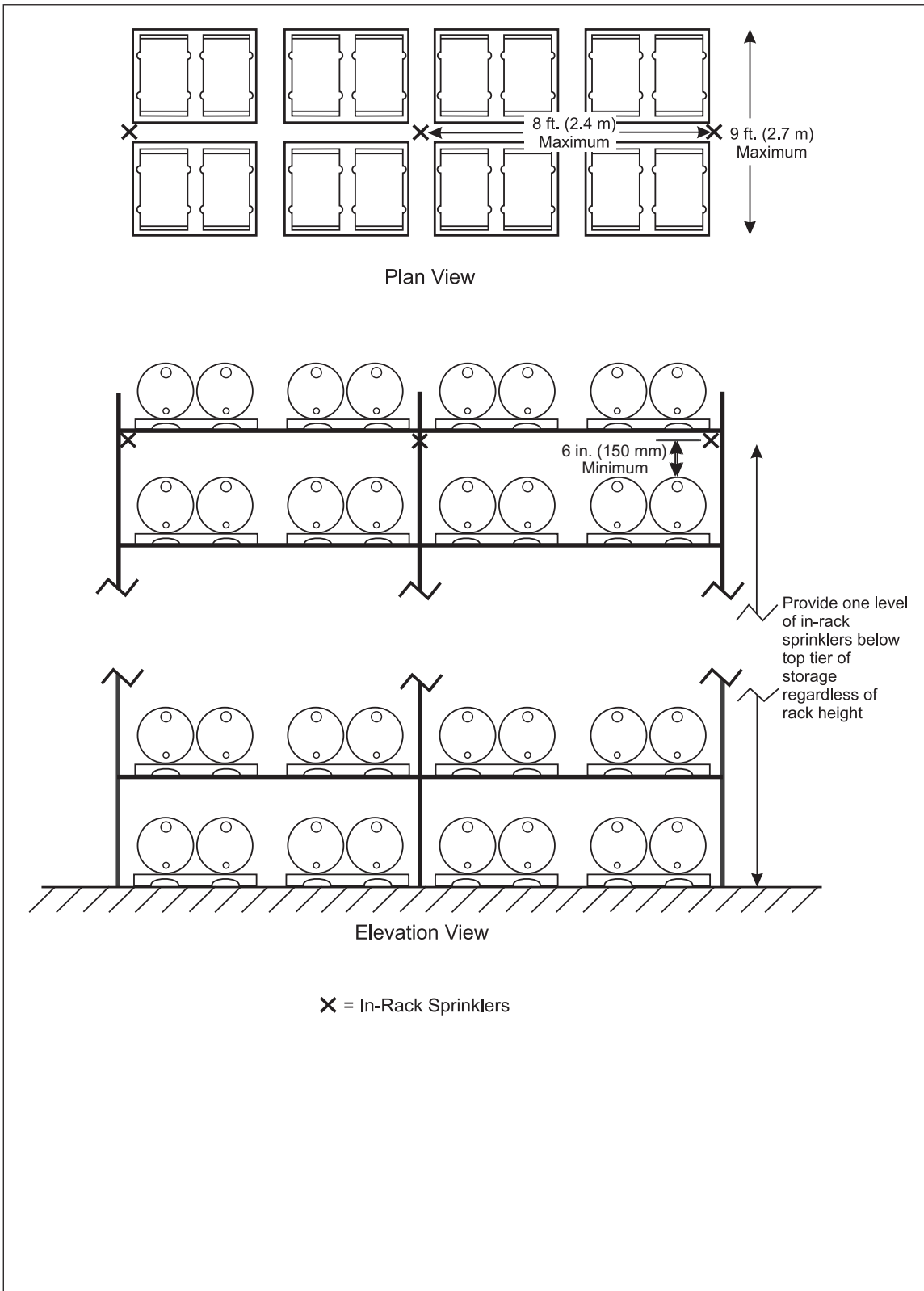

Fig. D.2.1.16. Double-row rack sprinkler layout: drum protection scheme

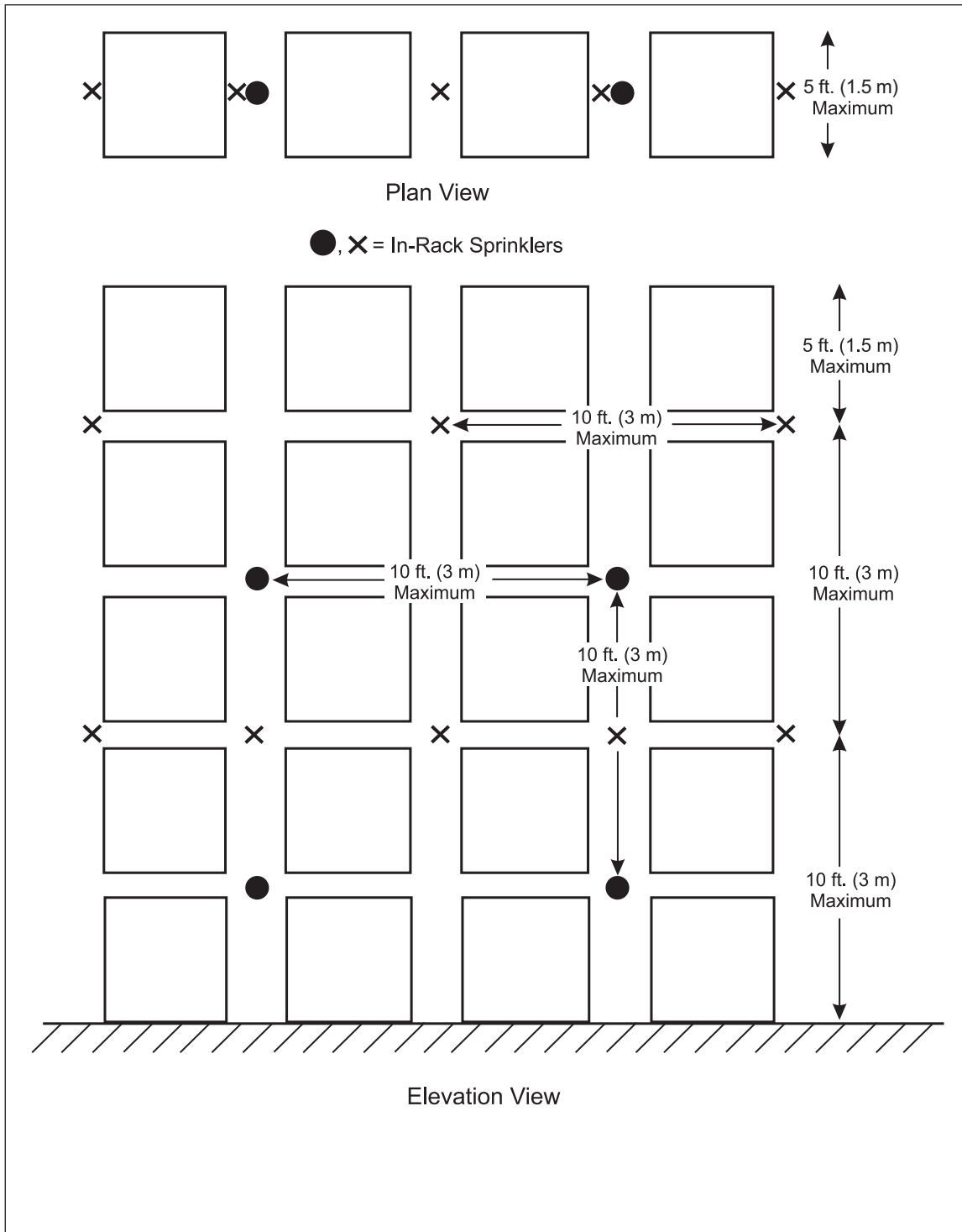

Fig. D.2.1.17. Single-row rack sprinkler layout: small metal containers

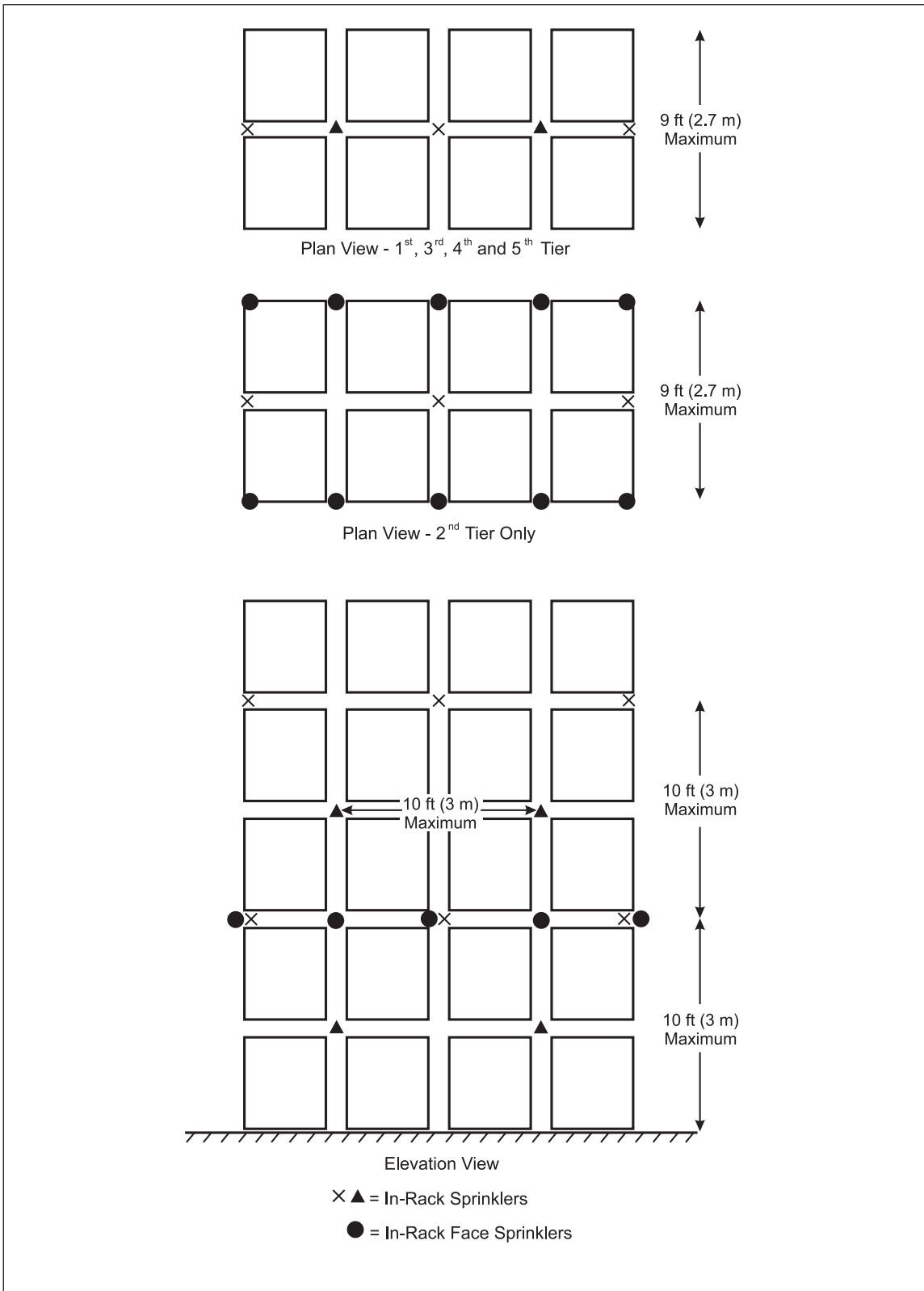

Fig. D.2.1.18. Double-row rack sprinkler layout: small metal containers (with face sprinklers)

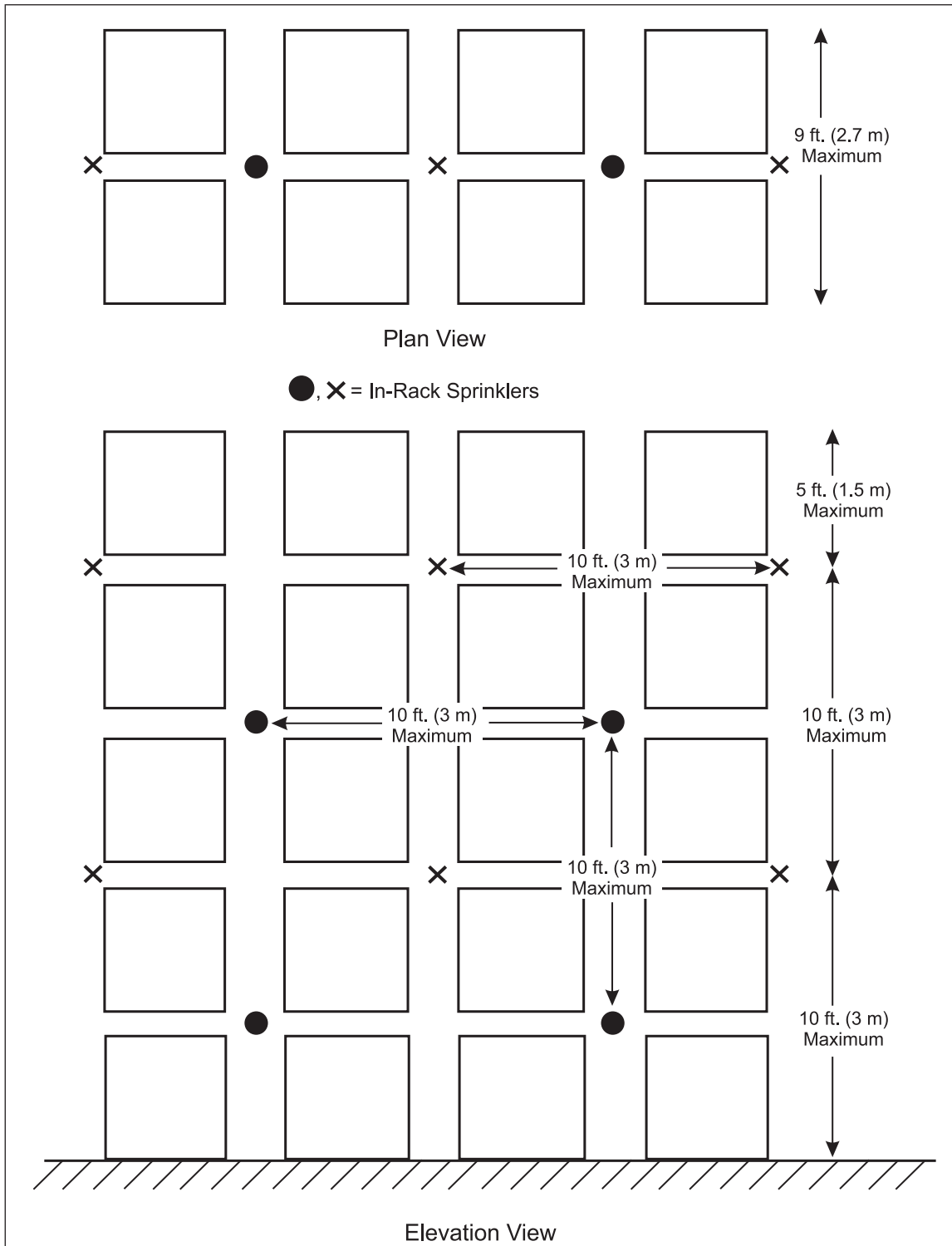

Fig. D.2.1.19. Double-row rack sprinkler layout: small metal containers (no face sprinklers)

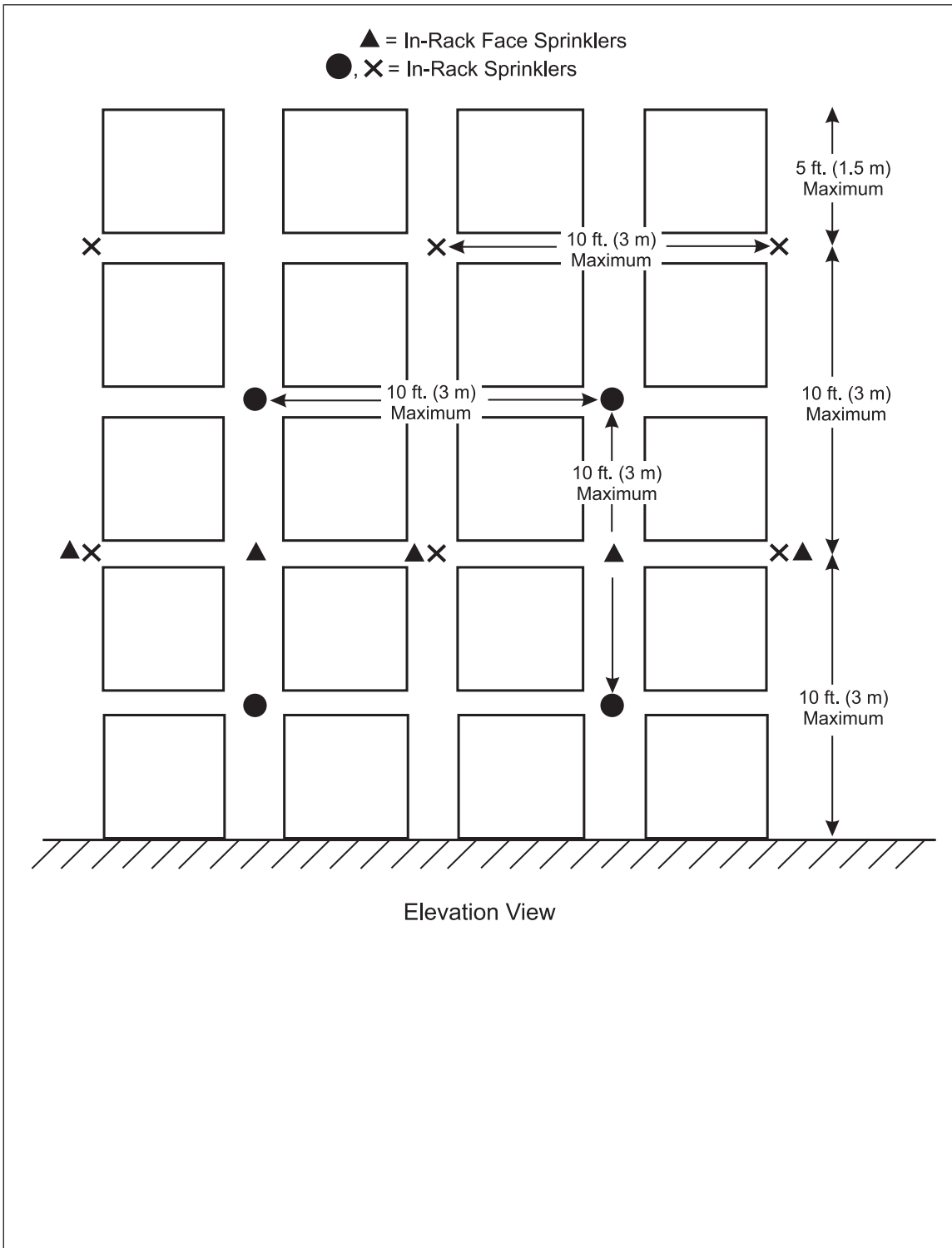

Fig. D.2.1.20. Multiple-row rack sprinkler layout: small metal containers (elevation view)

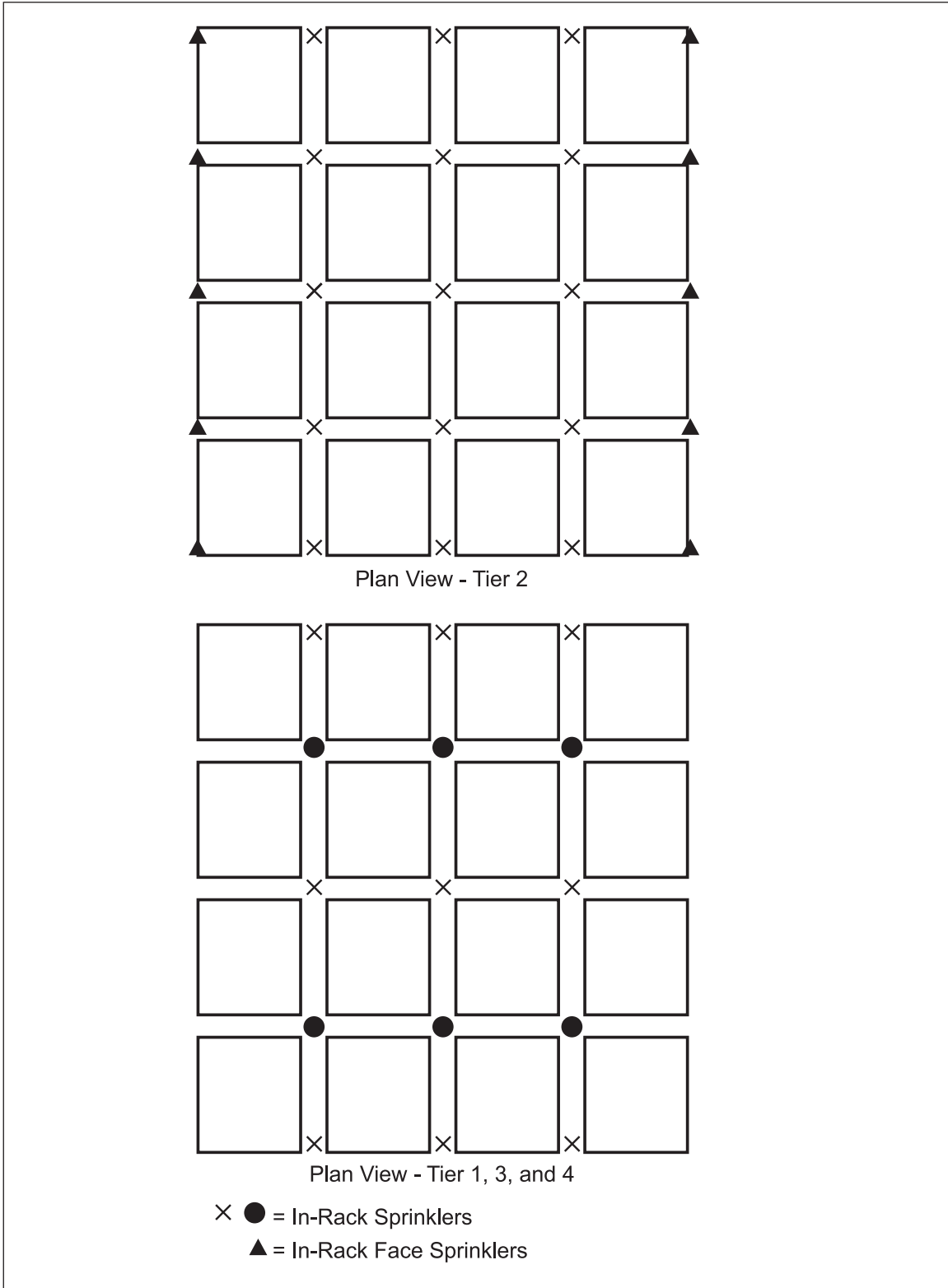

Fig. D.2.1.21. Multiple-row rack sprinkler layout: small metal containers (plan view)

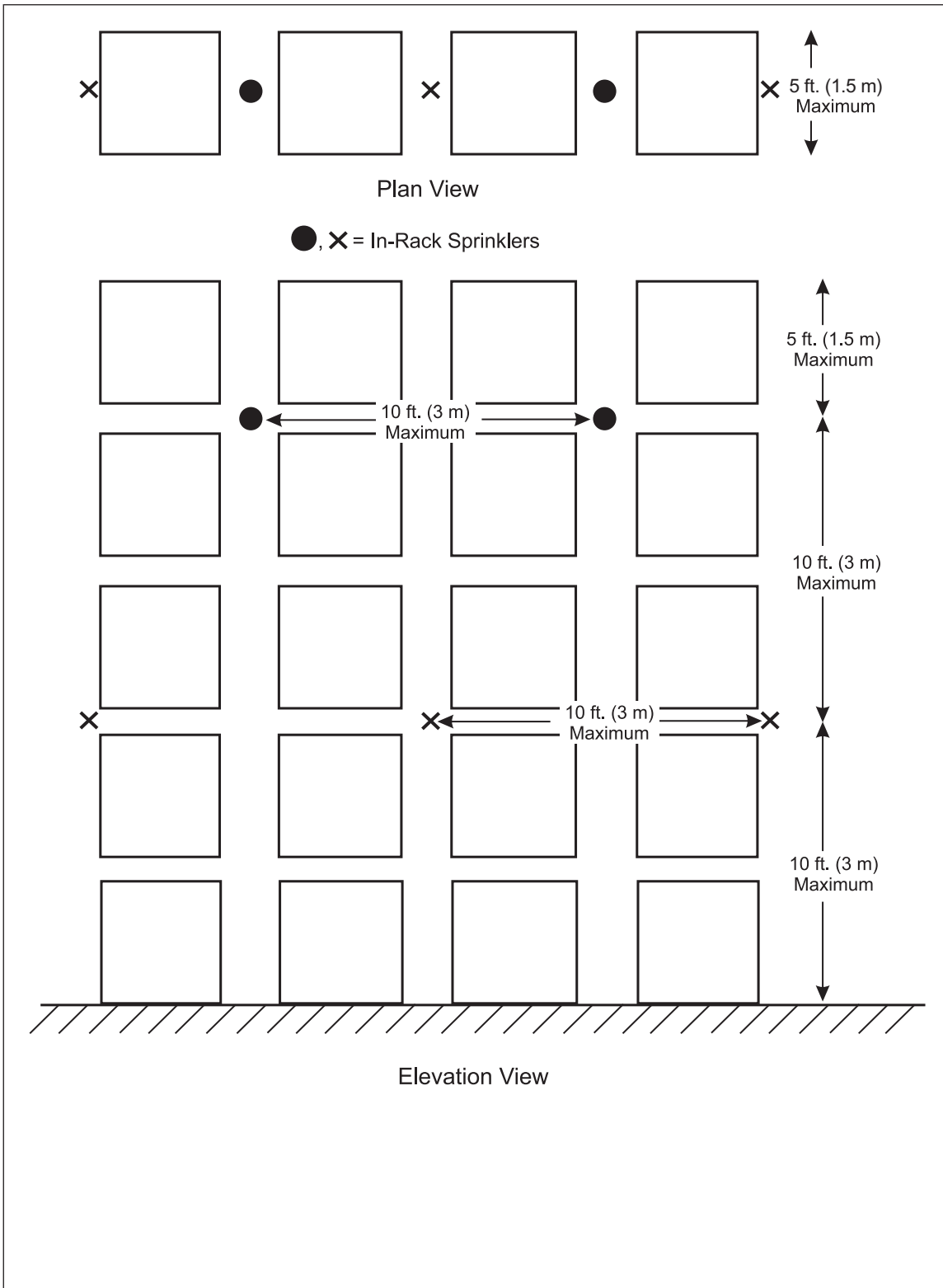

Fig. D.2.1.22. Single-row rack sprinkler layout: water-miscible liquids in small metal containers

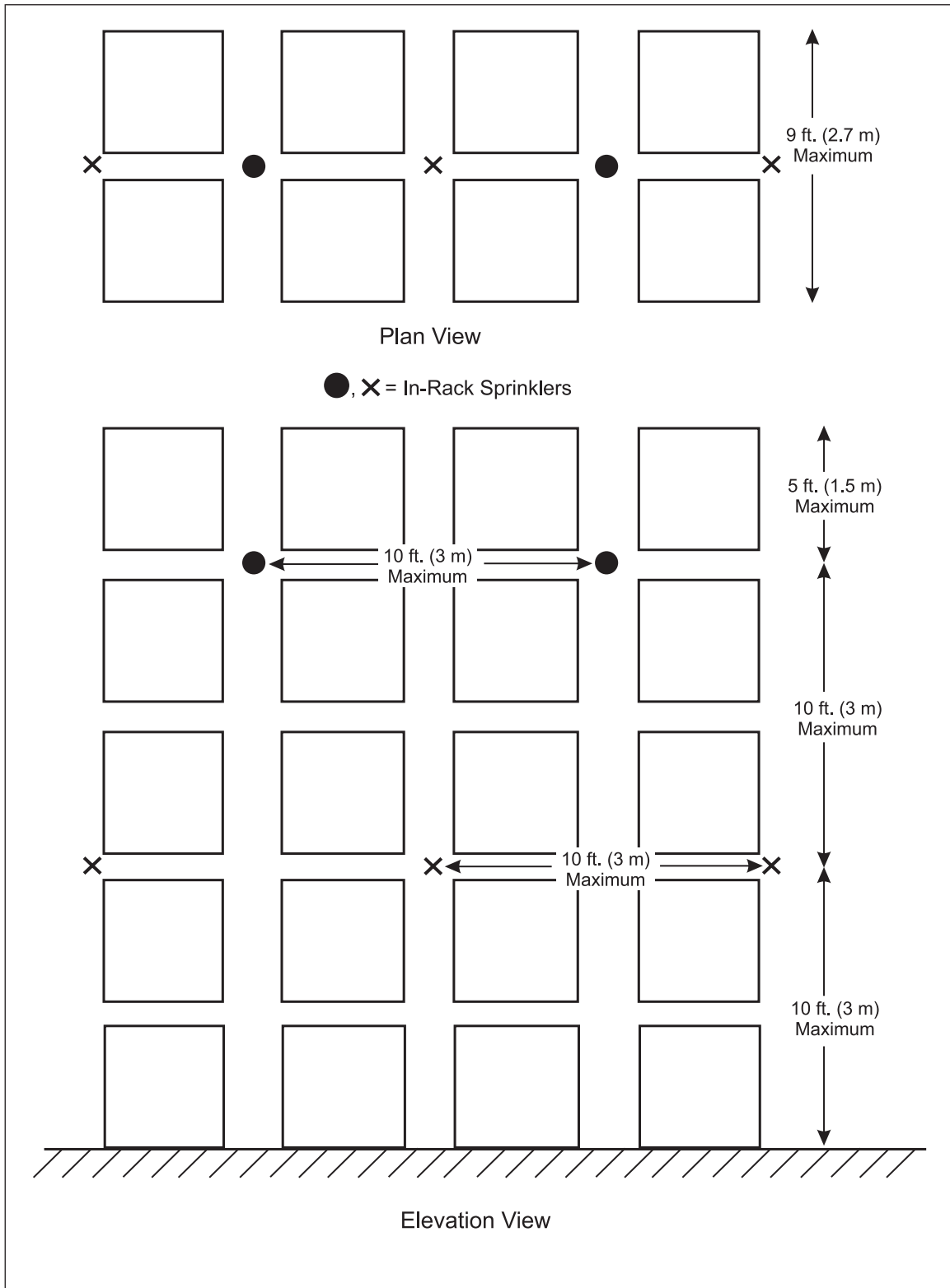

Fig. D.2.1.23. Double-row rack sprinkler layout: water-miscible liquids in small metal containers

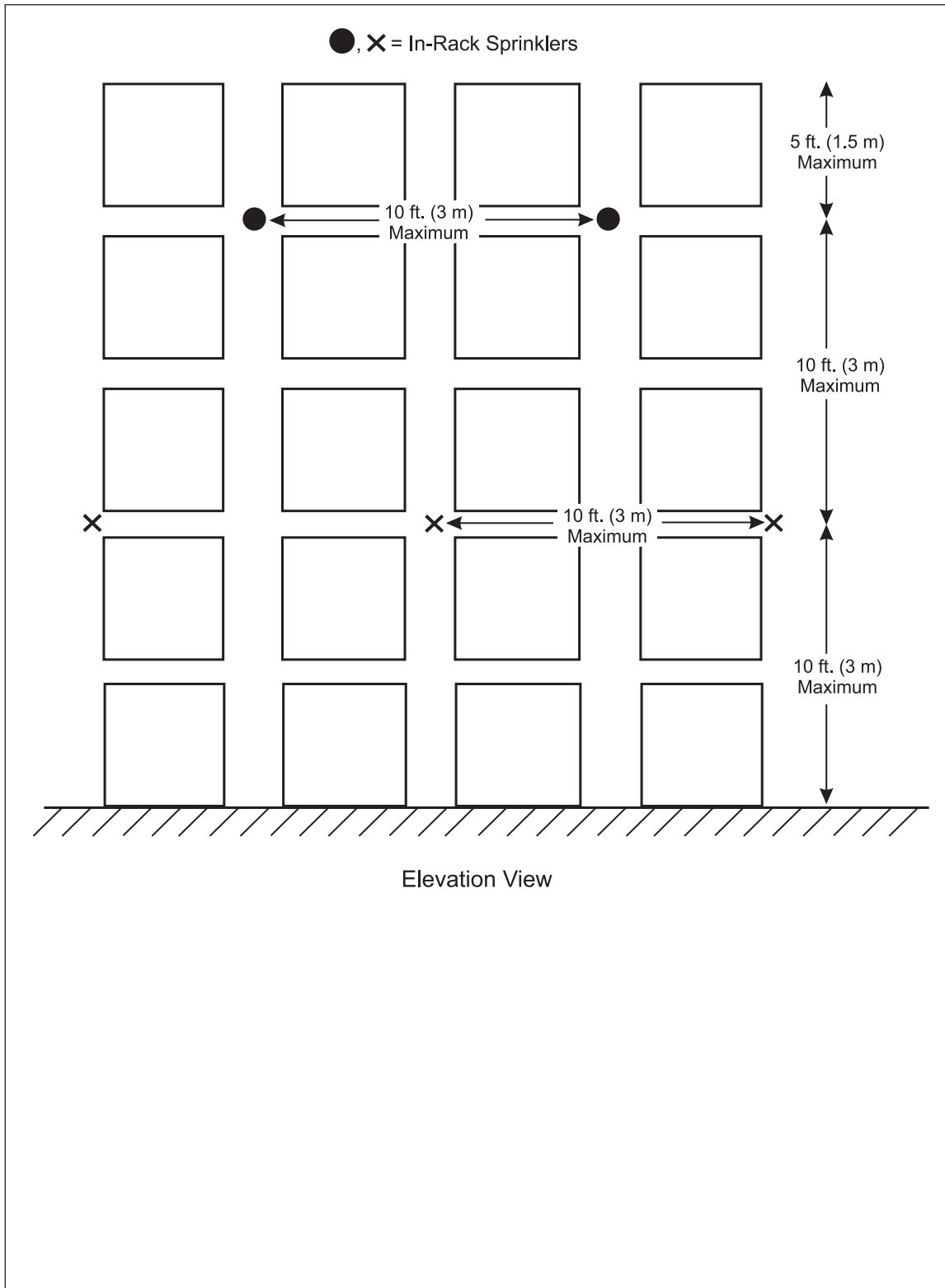

Fig. D.2.1.24. Multiple-row rack sprinkler layout: water-miscible liquids in small metal containers (elevation view)

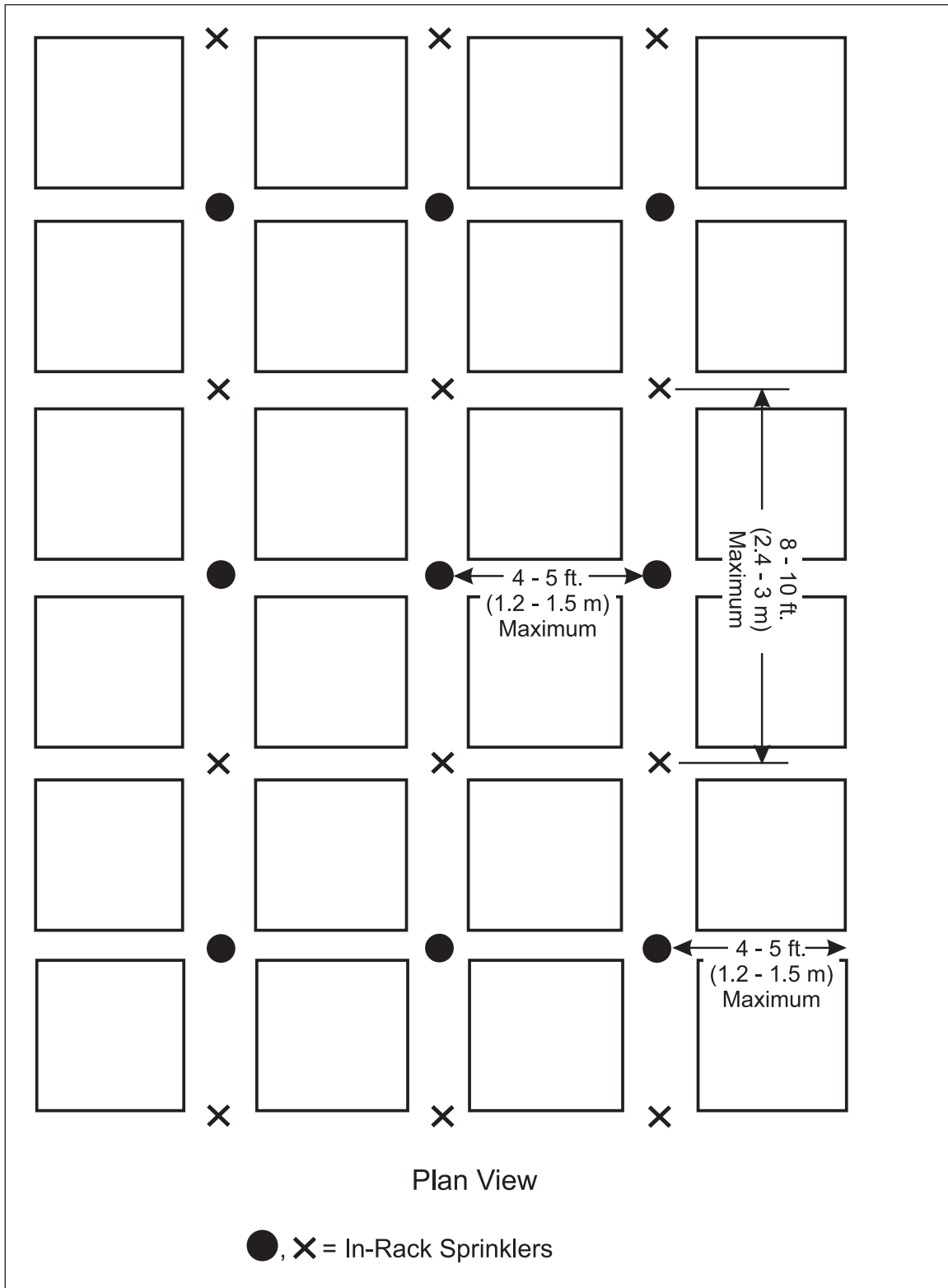

Fig. D.2.1.25. Multiple-row rack sprinkler layout: water-miscible liquids in small metal containers (plan view)

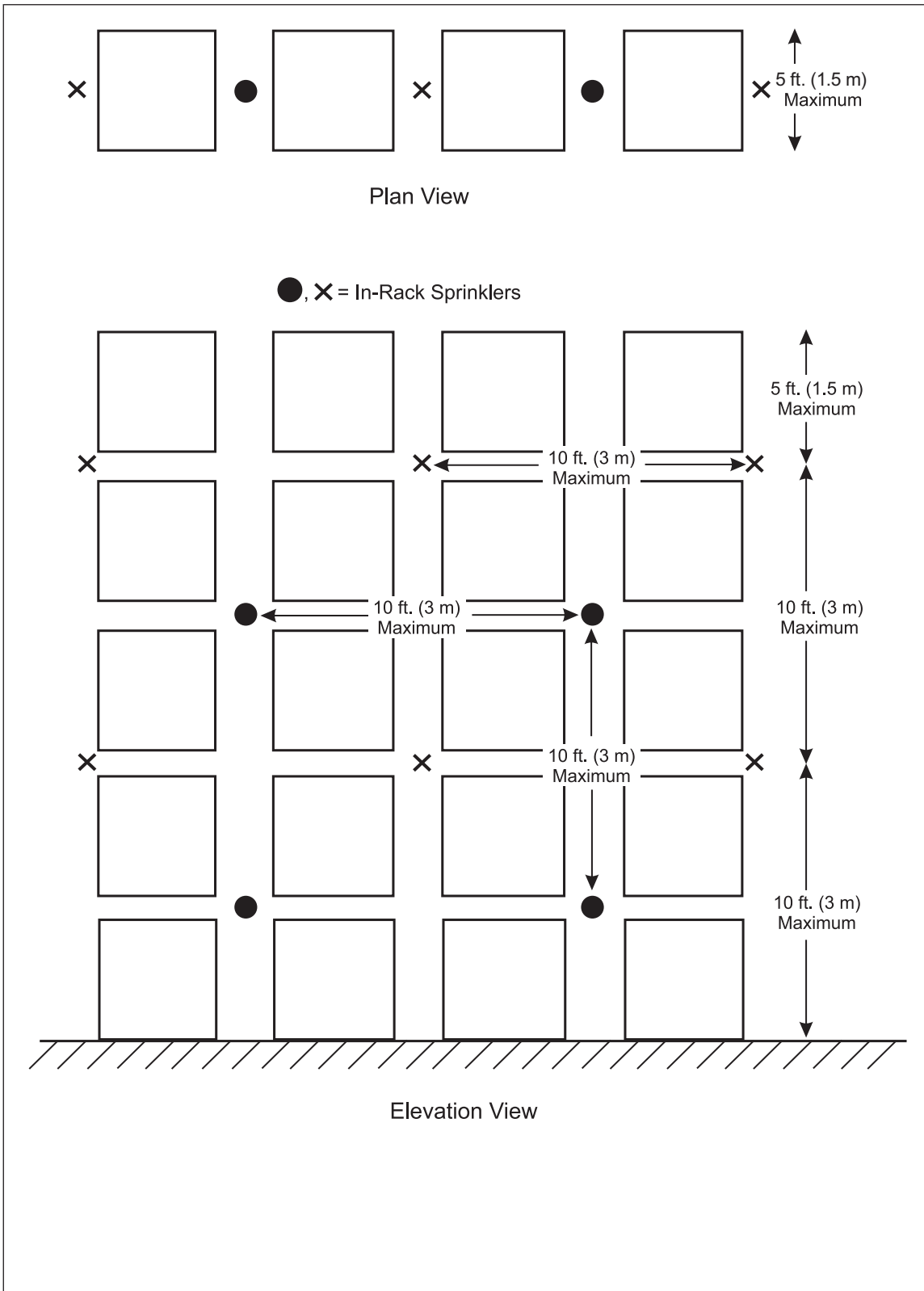

Fig. D.2.1.26. Single-row rack sprinkler layout: quick response sprinklers protection scheme

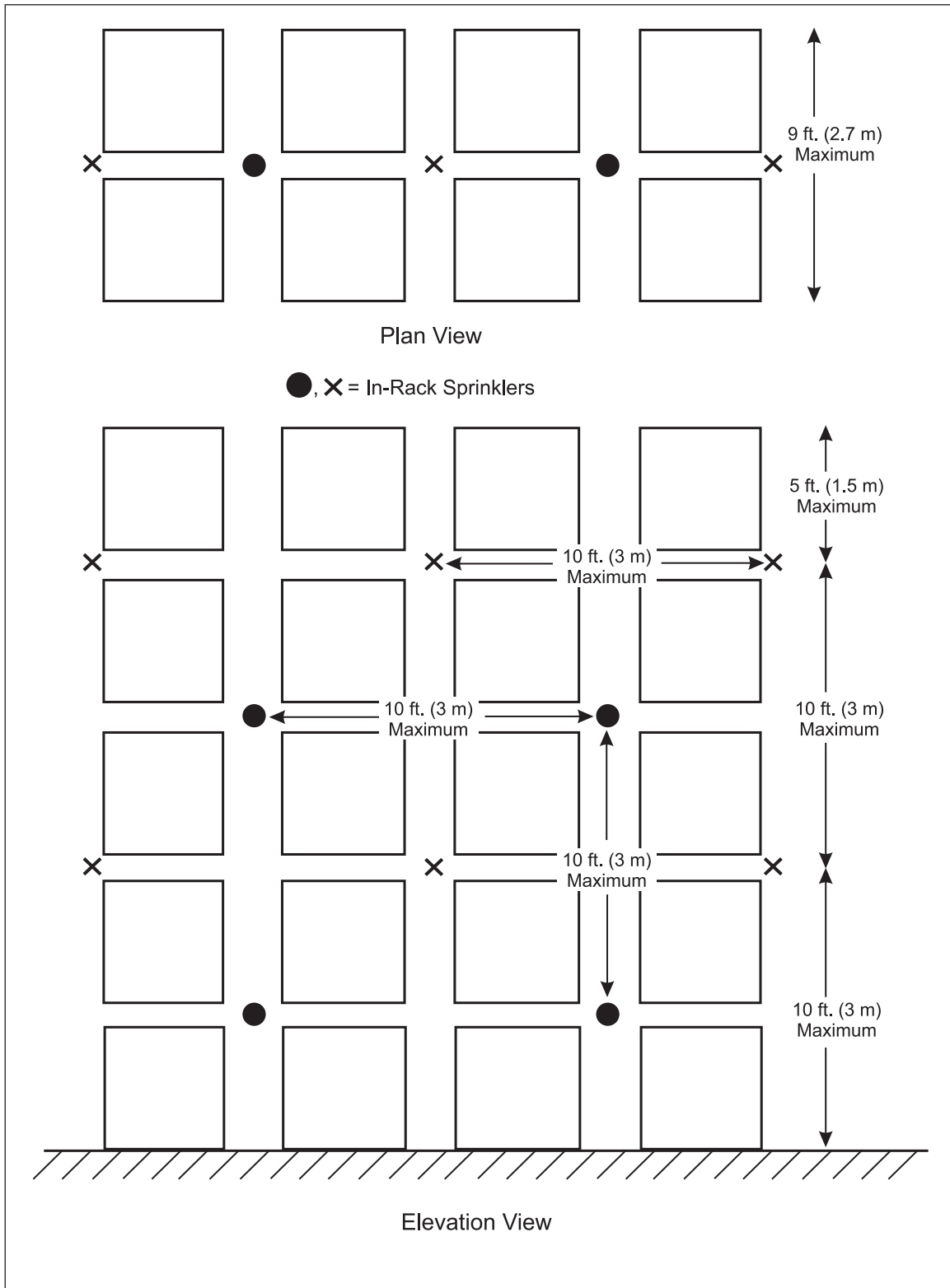

Fig. D.2.1.27. Double-row rack sprinkler layout: quick response sprinklers protection scheme

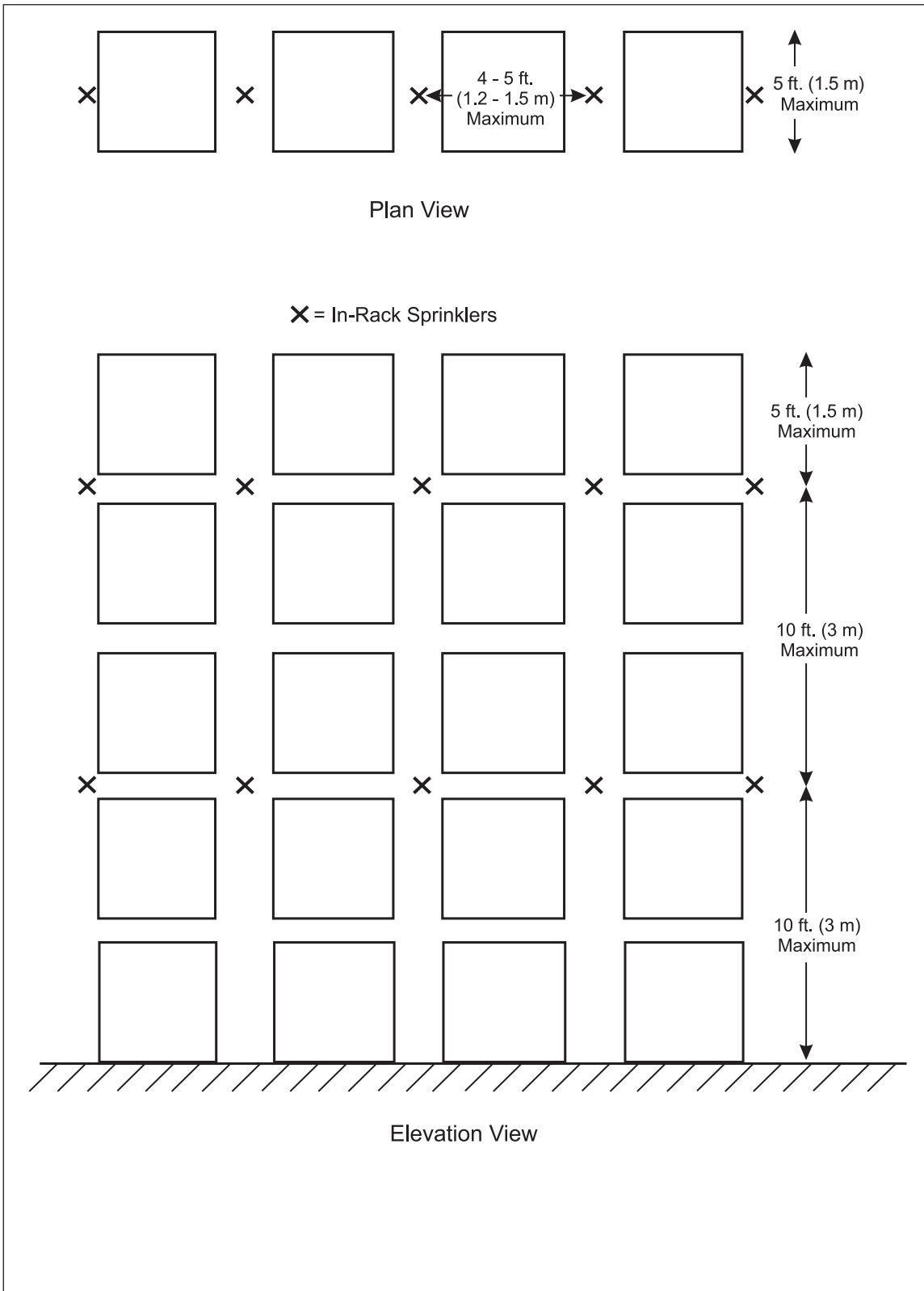

Fig. D.2.1.28. Single-row rack sprinkler layout: quick response sprinklers protection scheme

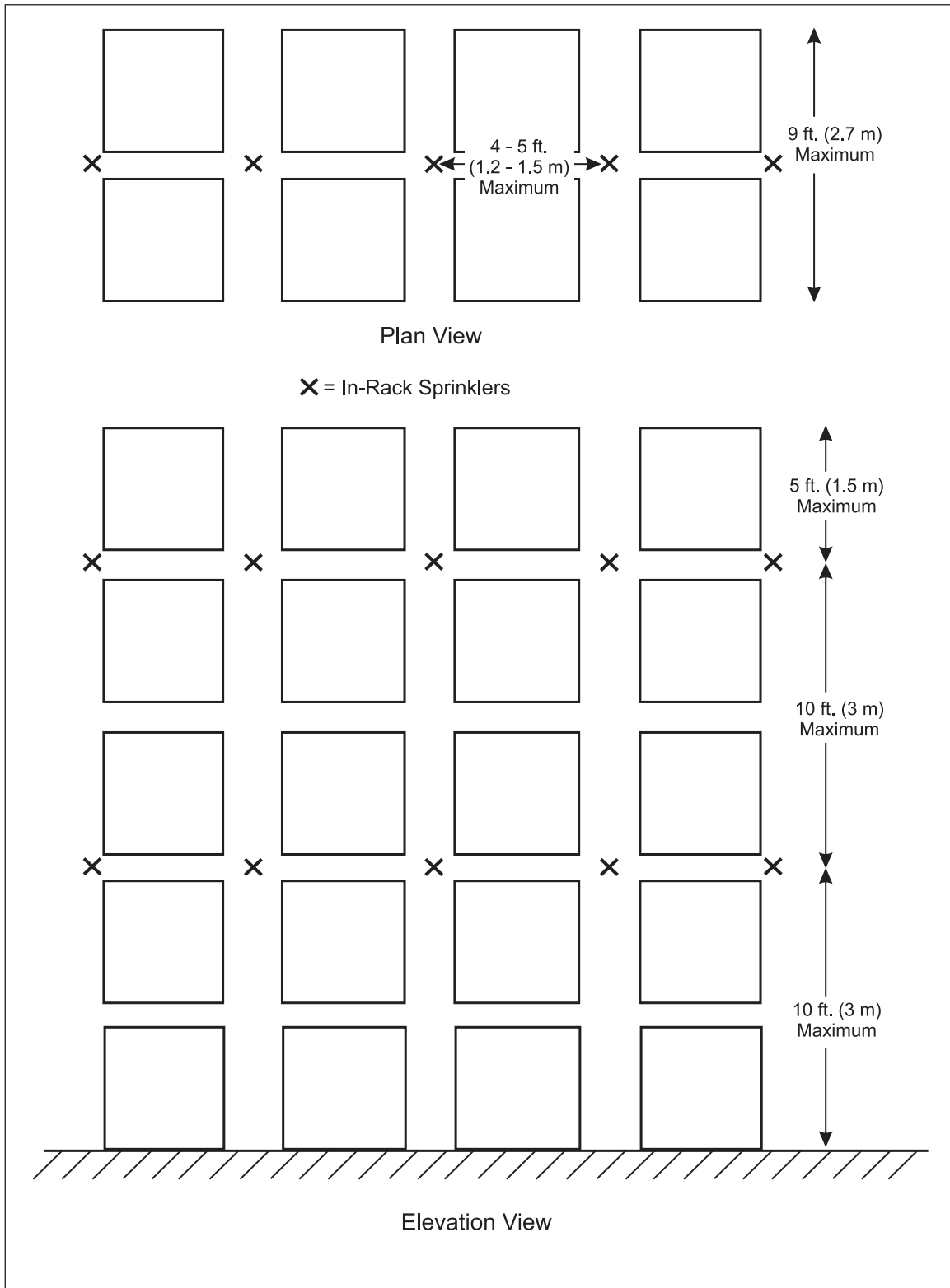

Fig. D.2.1.29. Double-row rack sprinkler layout: quick response sprinklers protection scheme

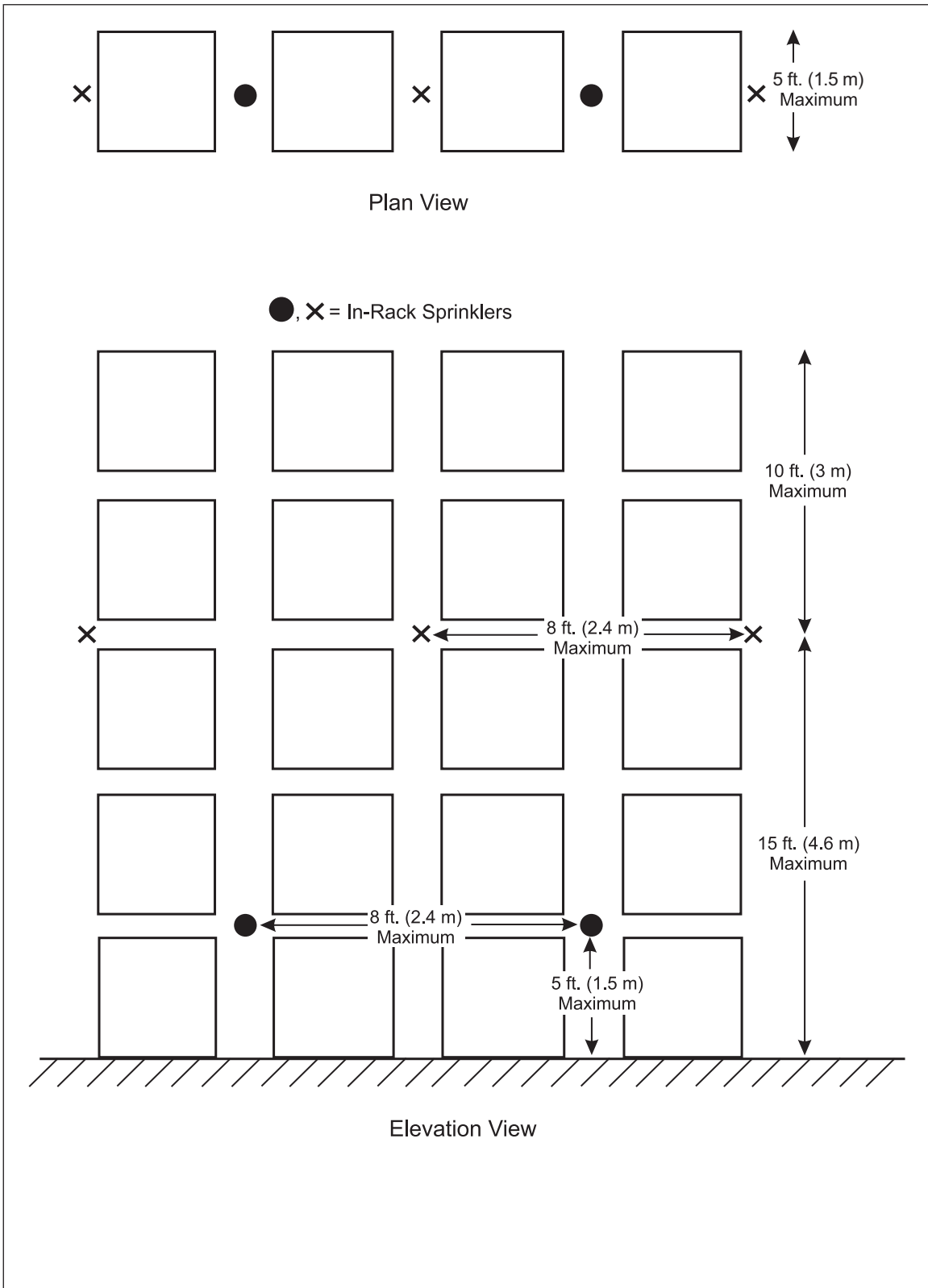

Fig. D.2.1.30. Single-row rack sprinkler layout: quick response sprinklers protection scheme

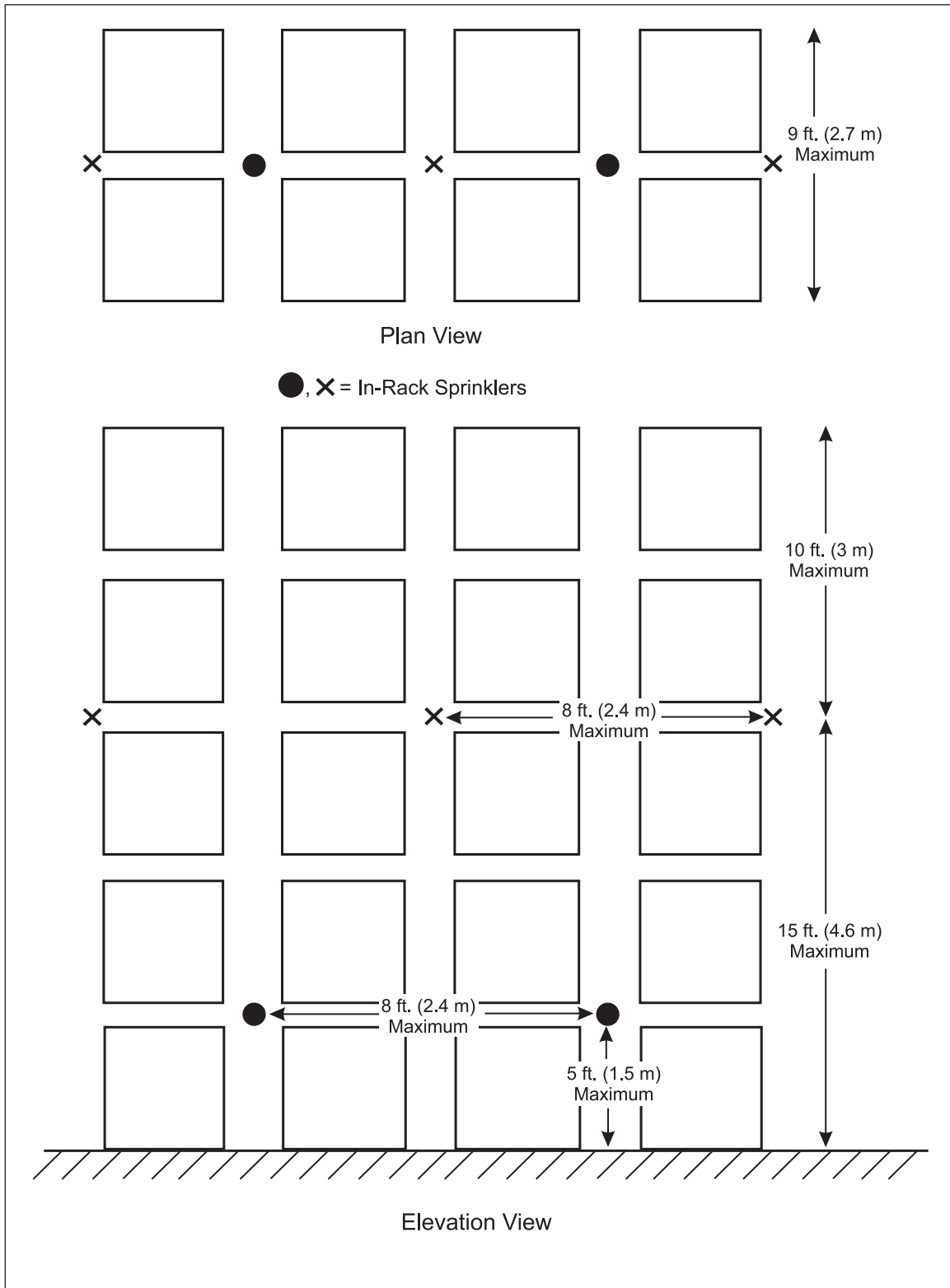

Fig. D.2.1.31. Double-row rack sprinkler layout: quick response sprinklers protection scheme

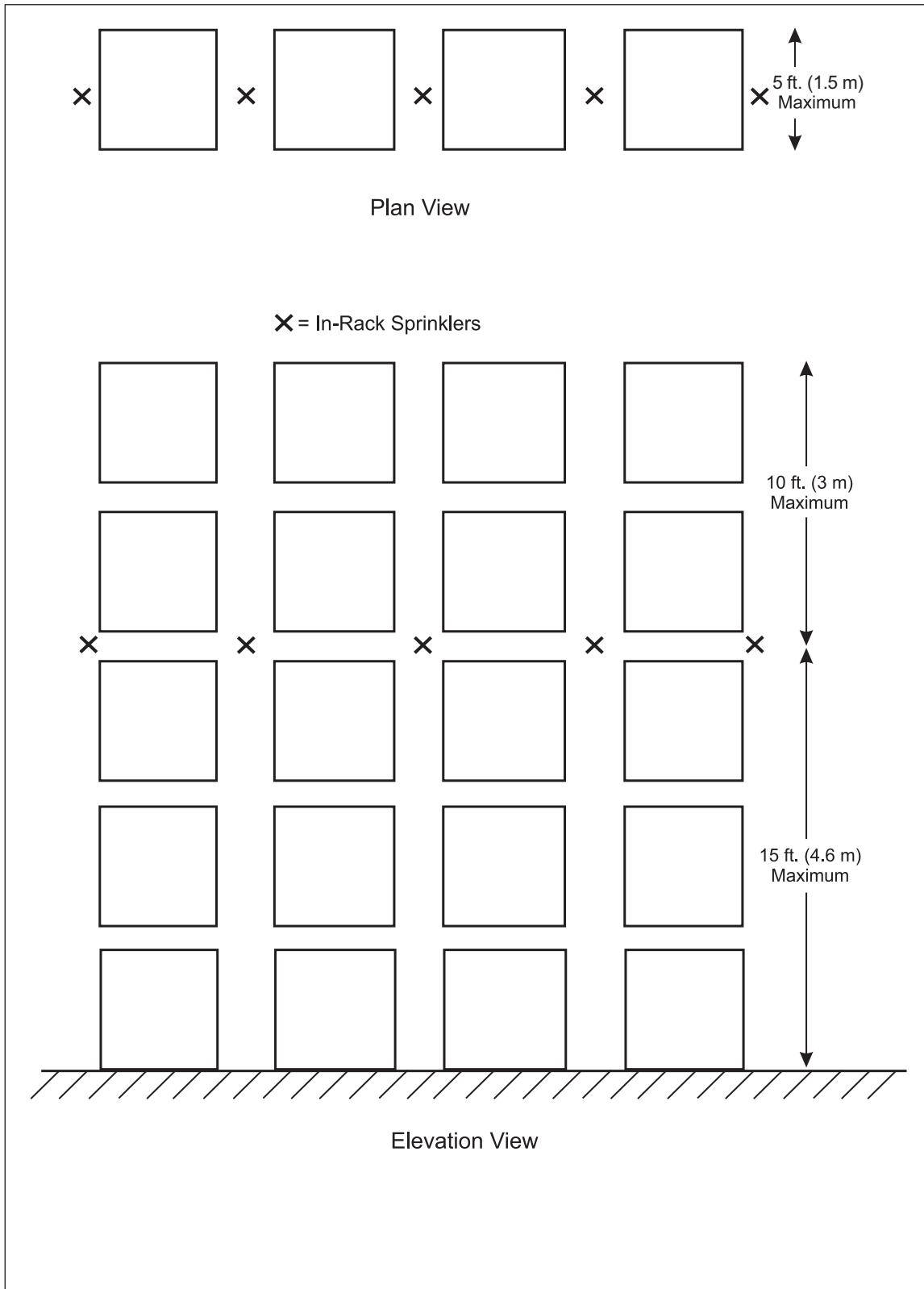

Fig. D.2.1.32. Single-row rack sprinkler layout: quick response sprinklers protection scheme

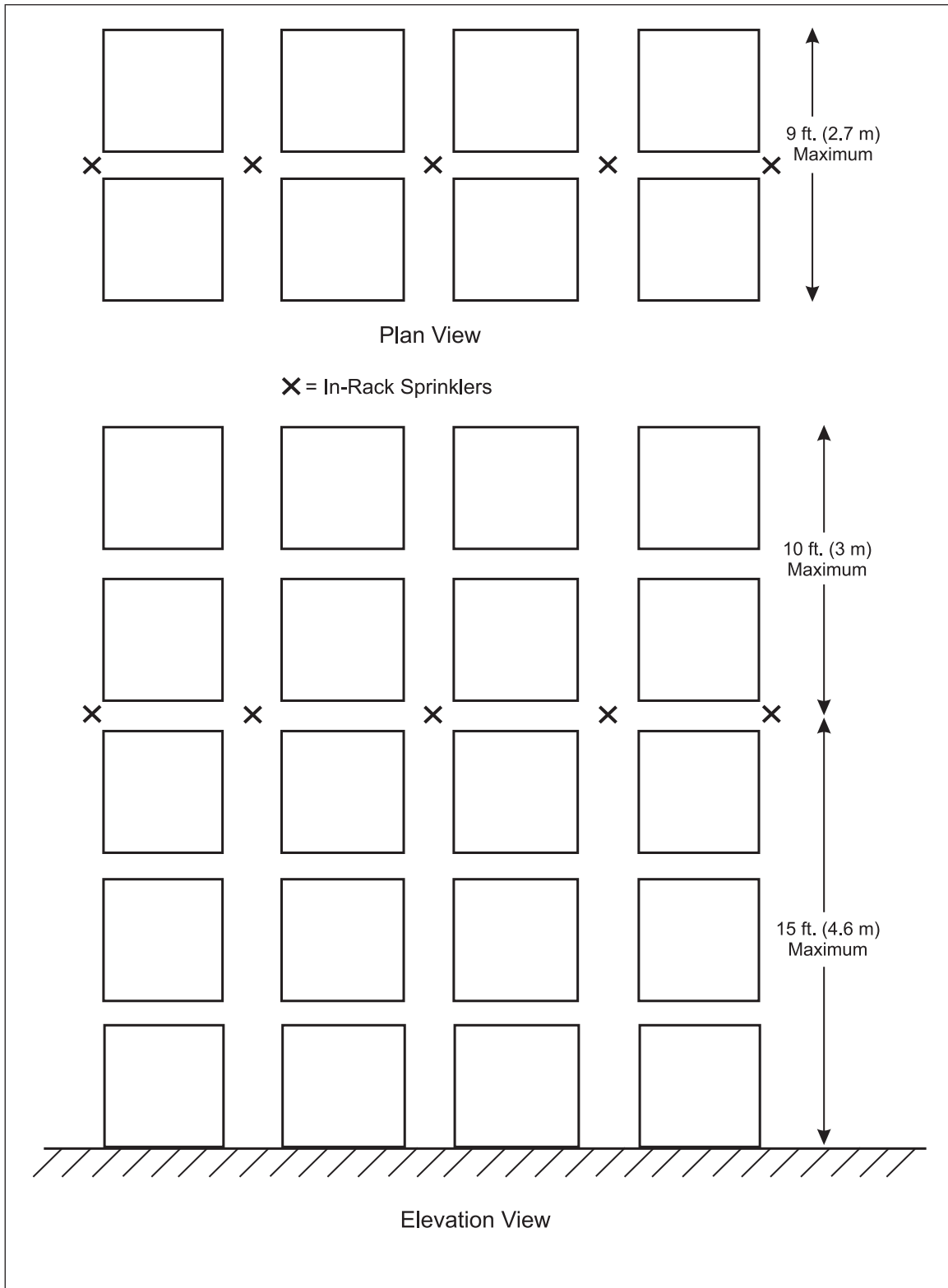

Fig. D.2.1.33. Double-row rack sprinkler layout: quick response sprinklers protection scheme

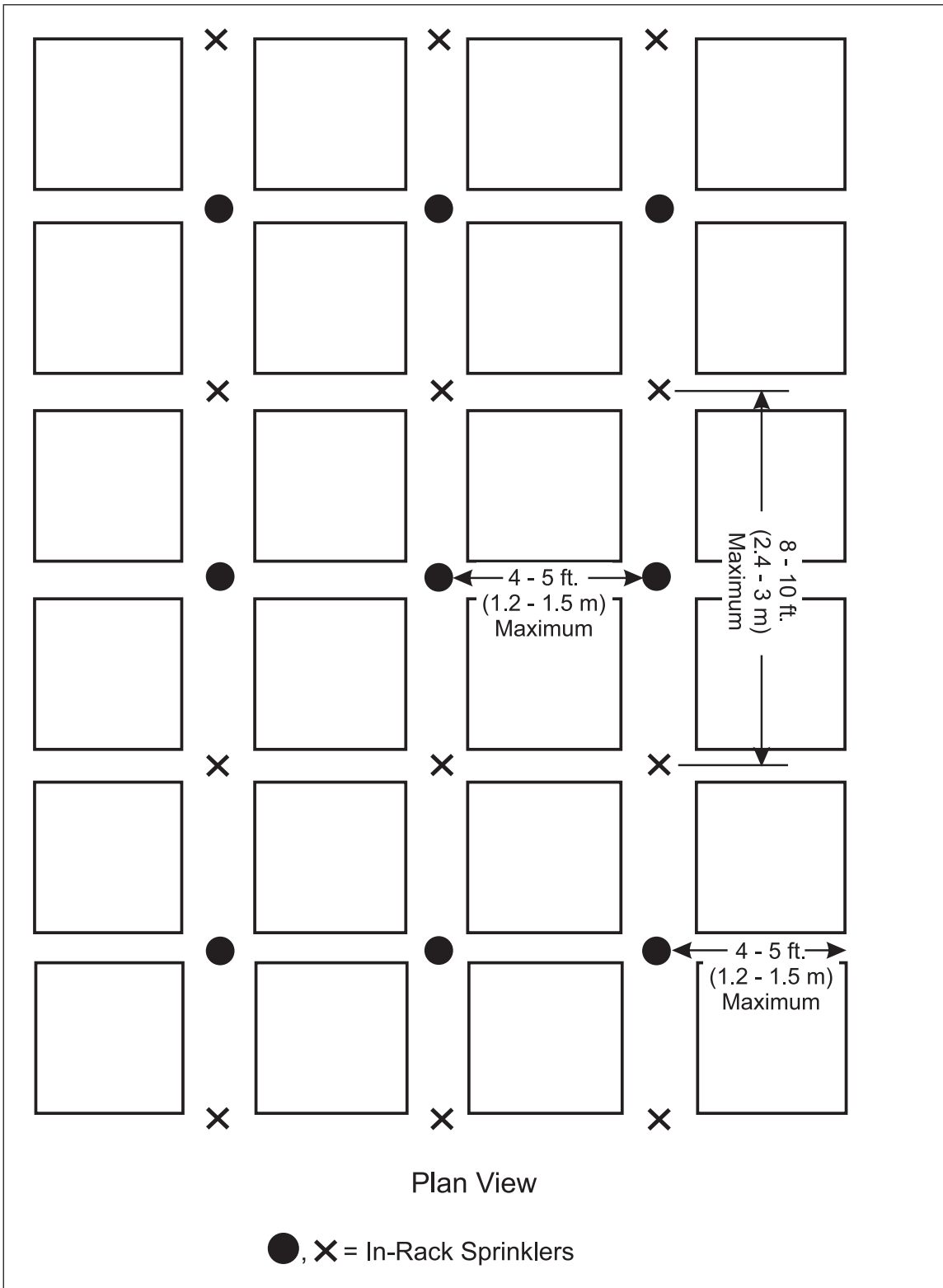

Fig. D.2.1.34. Multiple-row rack sprinkler layout: quick response sprinklers protection scheme (plan view)

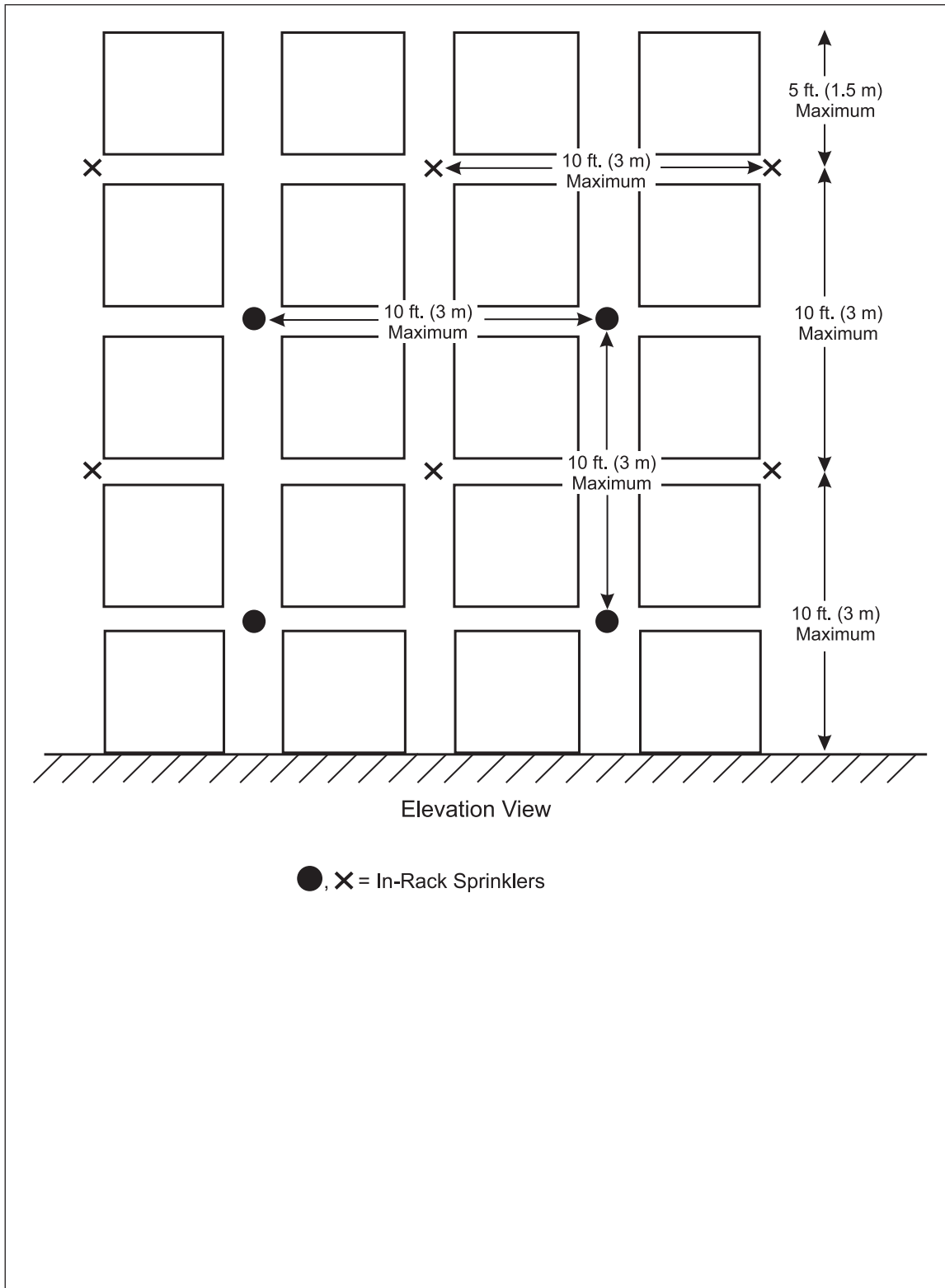

Fig. D.2.1.35. Multiple-row rack sprinkler layout: quick response sprinklers protection scheme (elevation view)

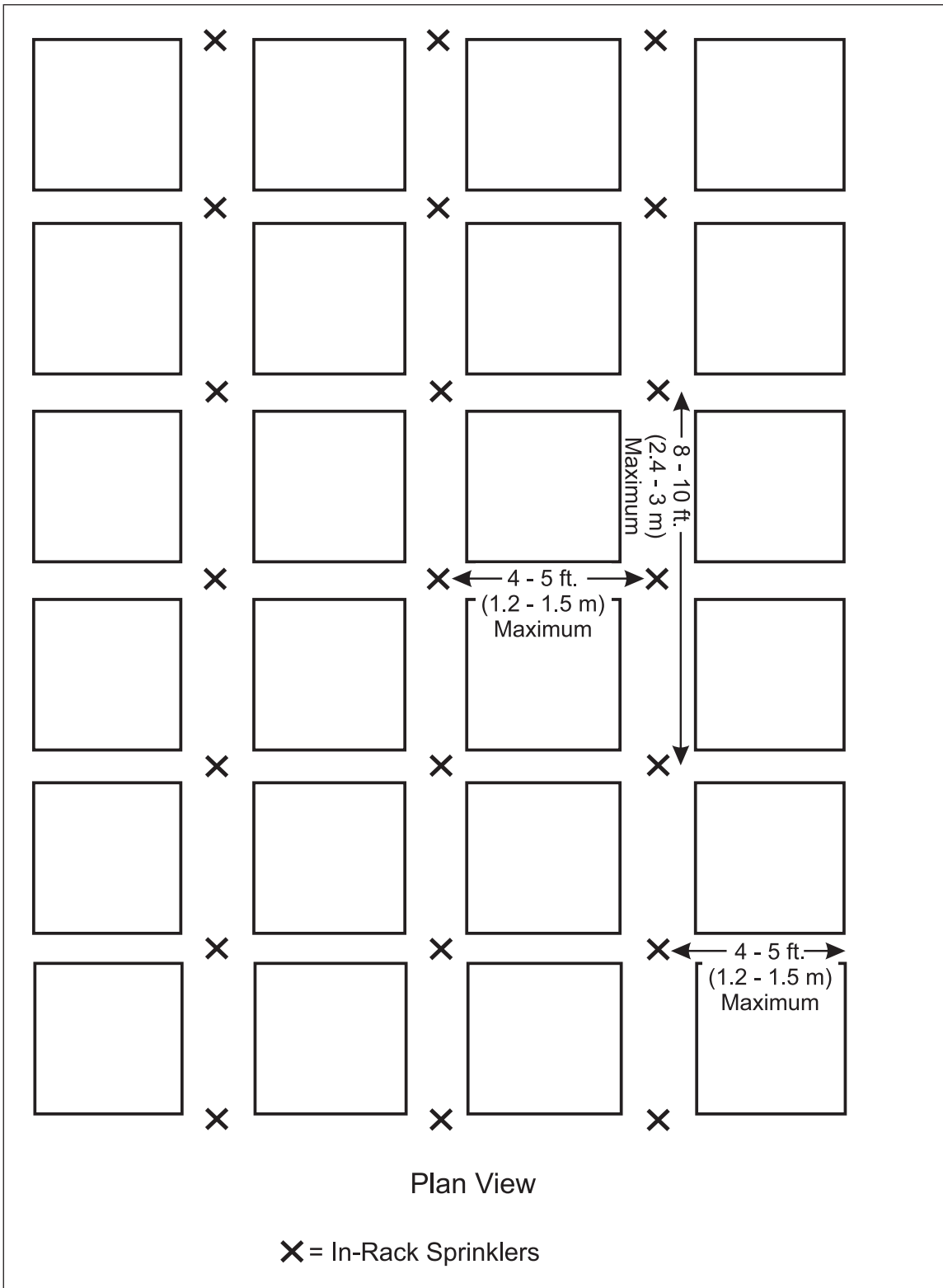

Fig. D.2.1.36. Multiple-row rack sprinkler layout: quick response sprinklers protection scheme (plan view)

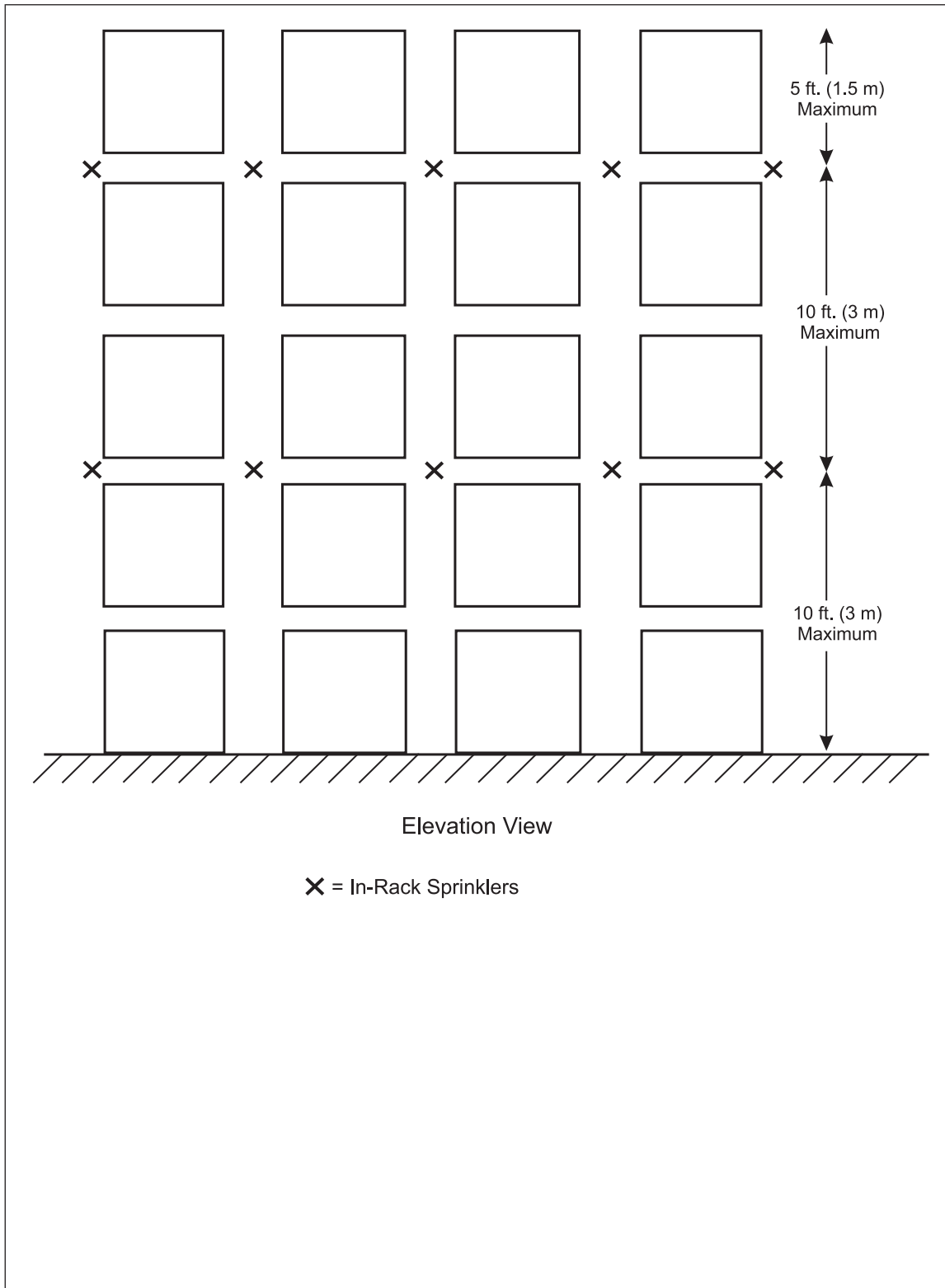

Fig. D.2.1.37. Multiple-row rack sprinkler layout: quick response sprinklers protection scheme (elevation view)

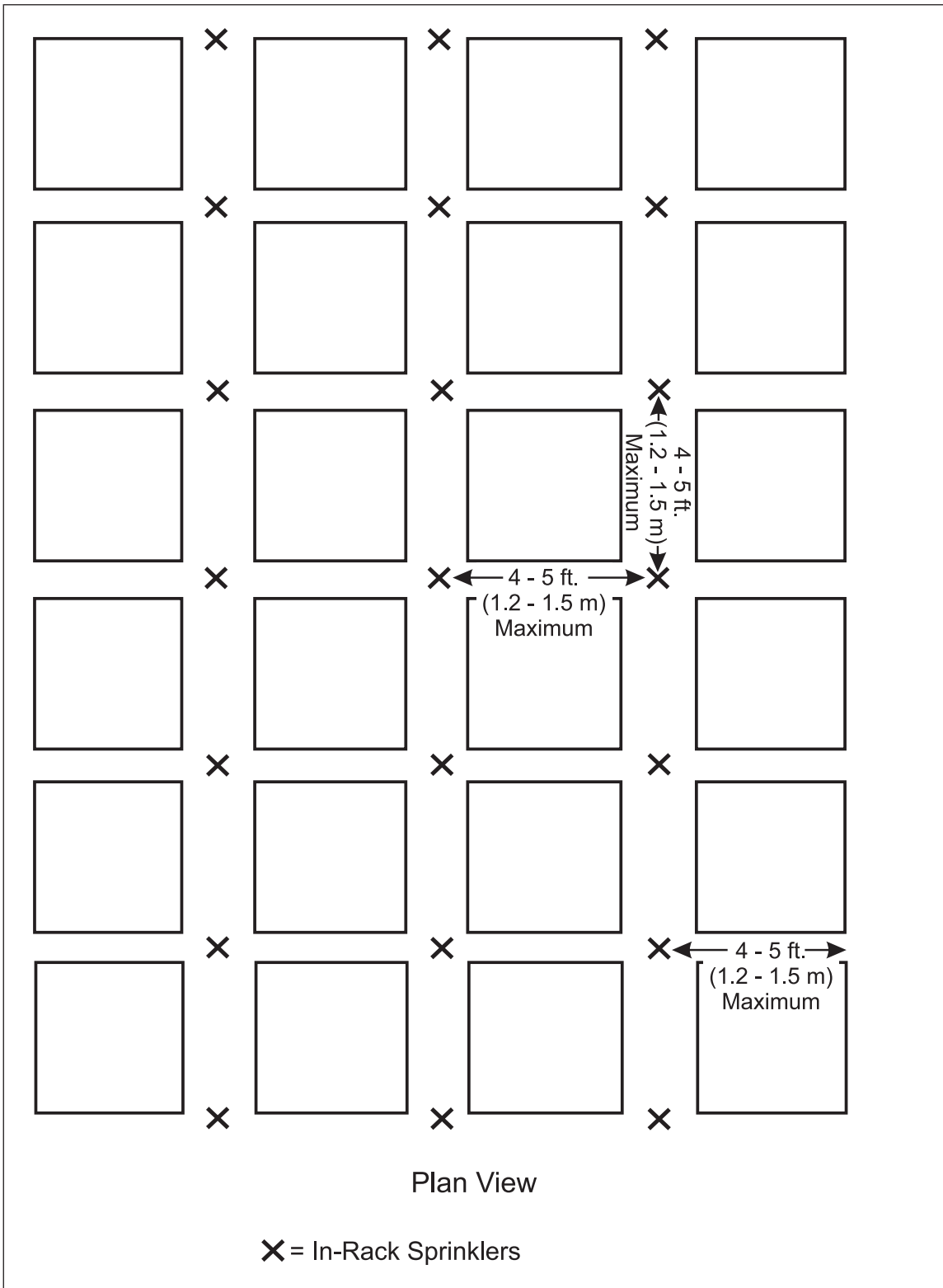

Fig. D.2.1.38. Multiple-row rack sprinkler layout: quick response sprinklers protection scheme (plan view)

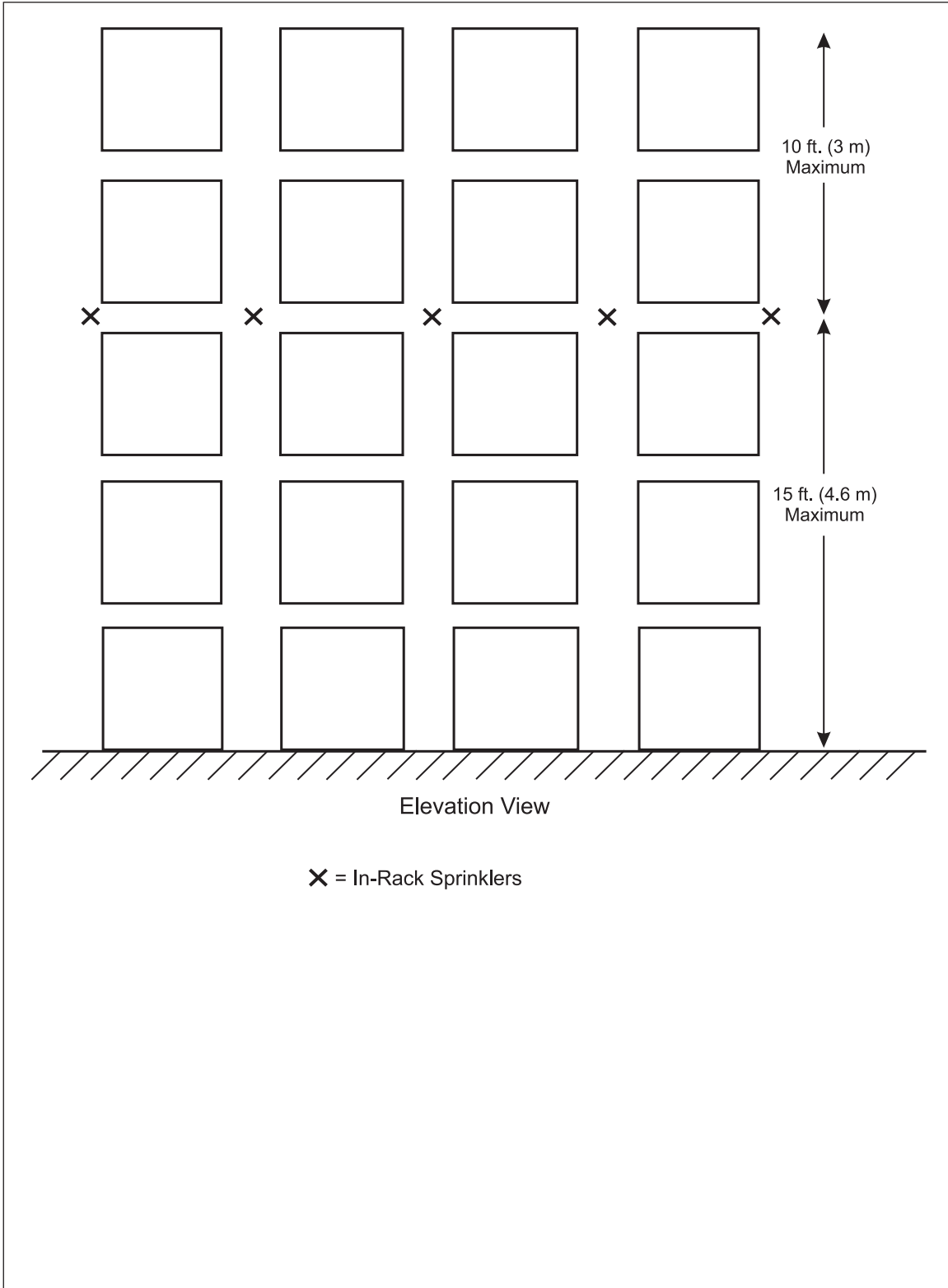

Fig. D.2.1.39. Multiple-row rack sprinkler layout: quick response sprinklers protection scheme (elevation view)

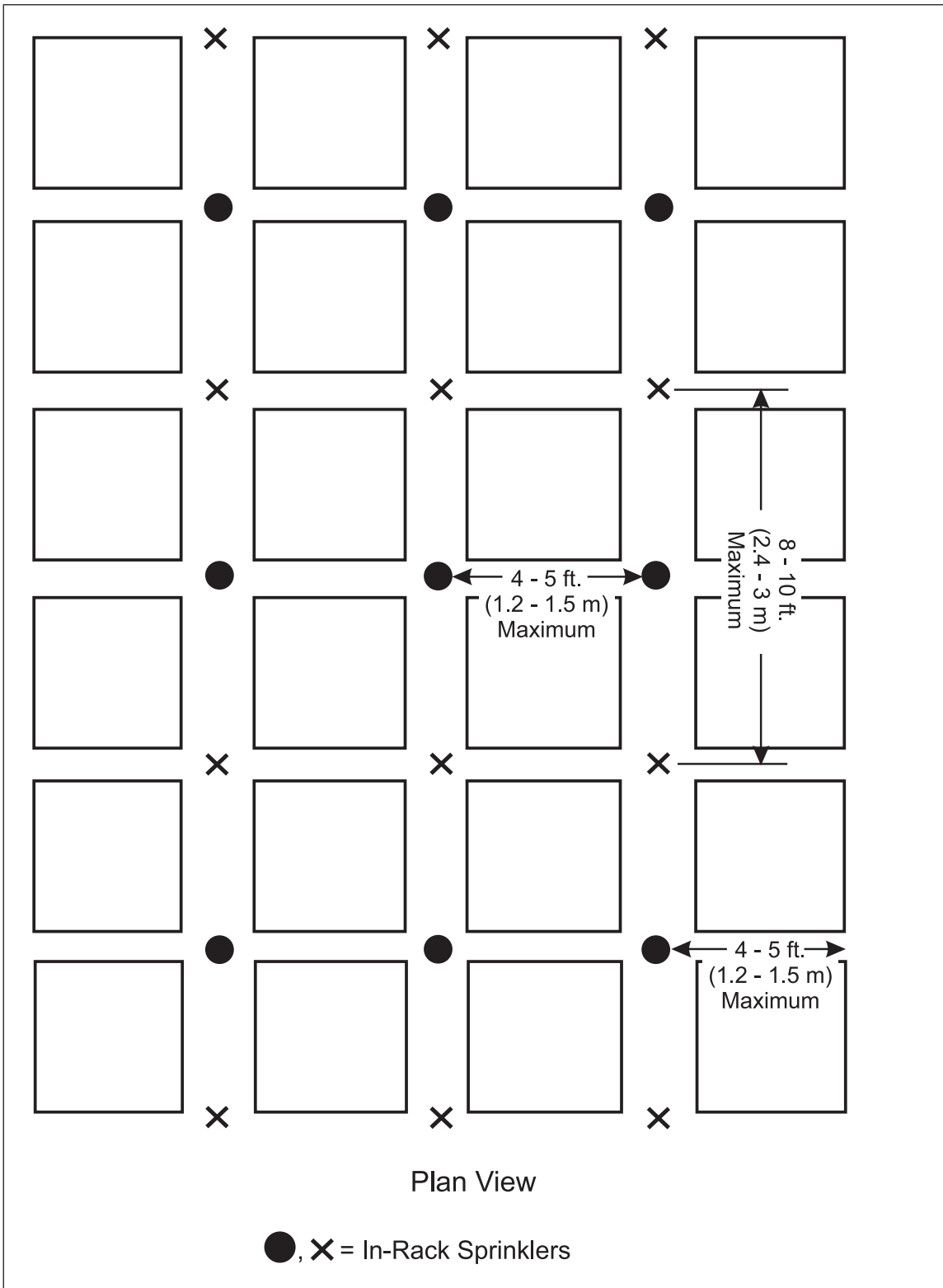

Fig. D.2.1.40. Multiple-row rack sprinkler layout: quick response sprinklers protection scheme (plan view)

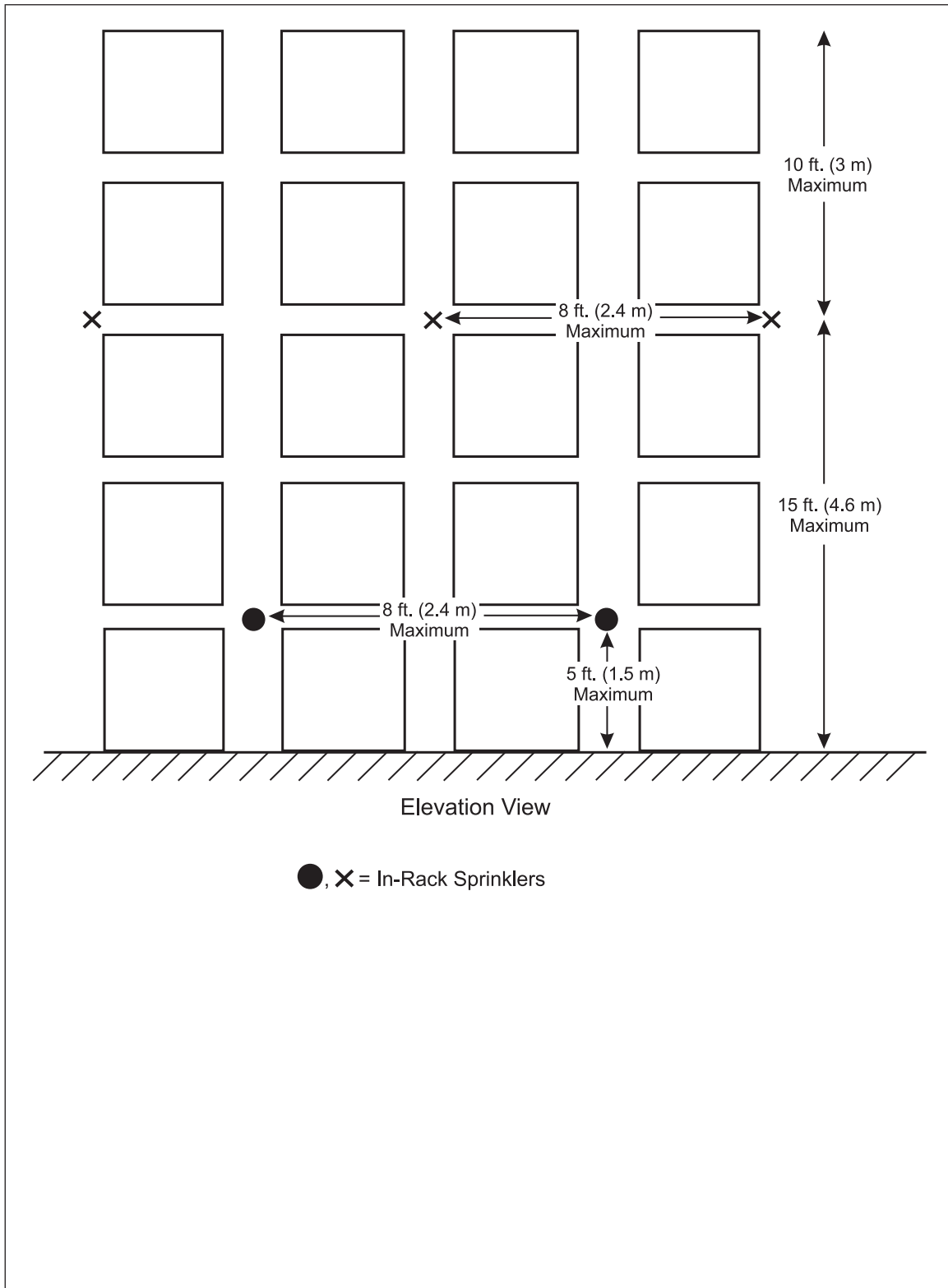

Fig. D.2.1.41. Multiple-row rack sprinkler layout: quick response sprinklers protection scheme (elevation view)

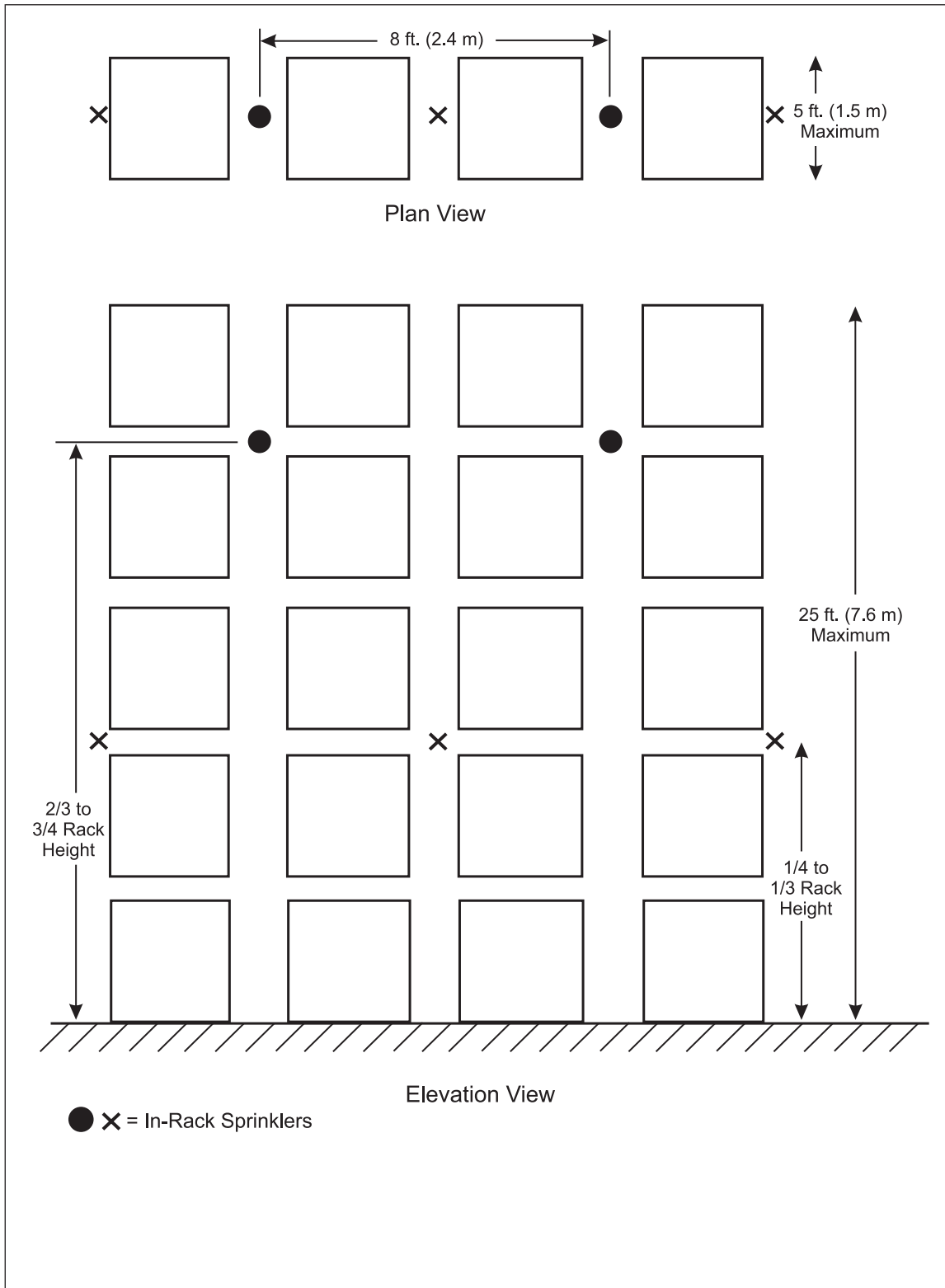

Fig. D.2.1.42. Single-row rack storage of water-miscible liquids

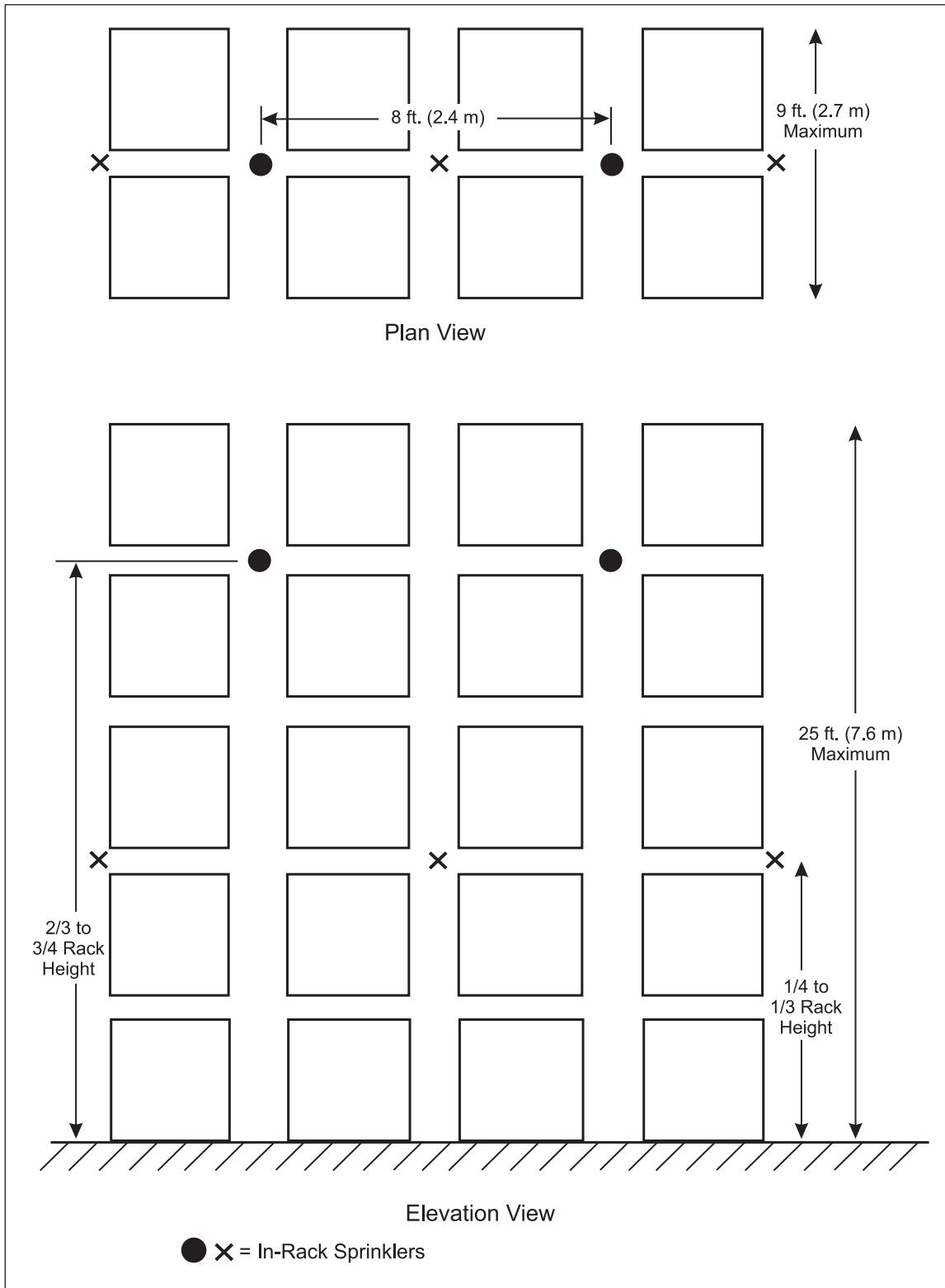

Fig. D.2.1.43. Double-row rack storage of water-miscible liquids

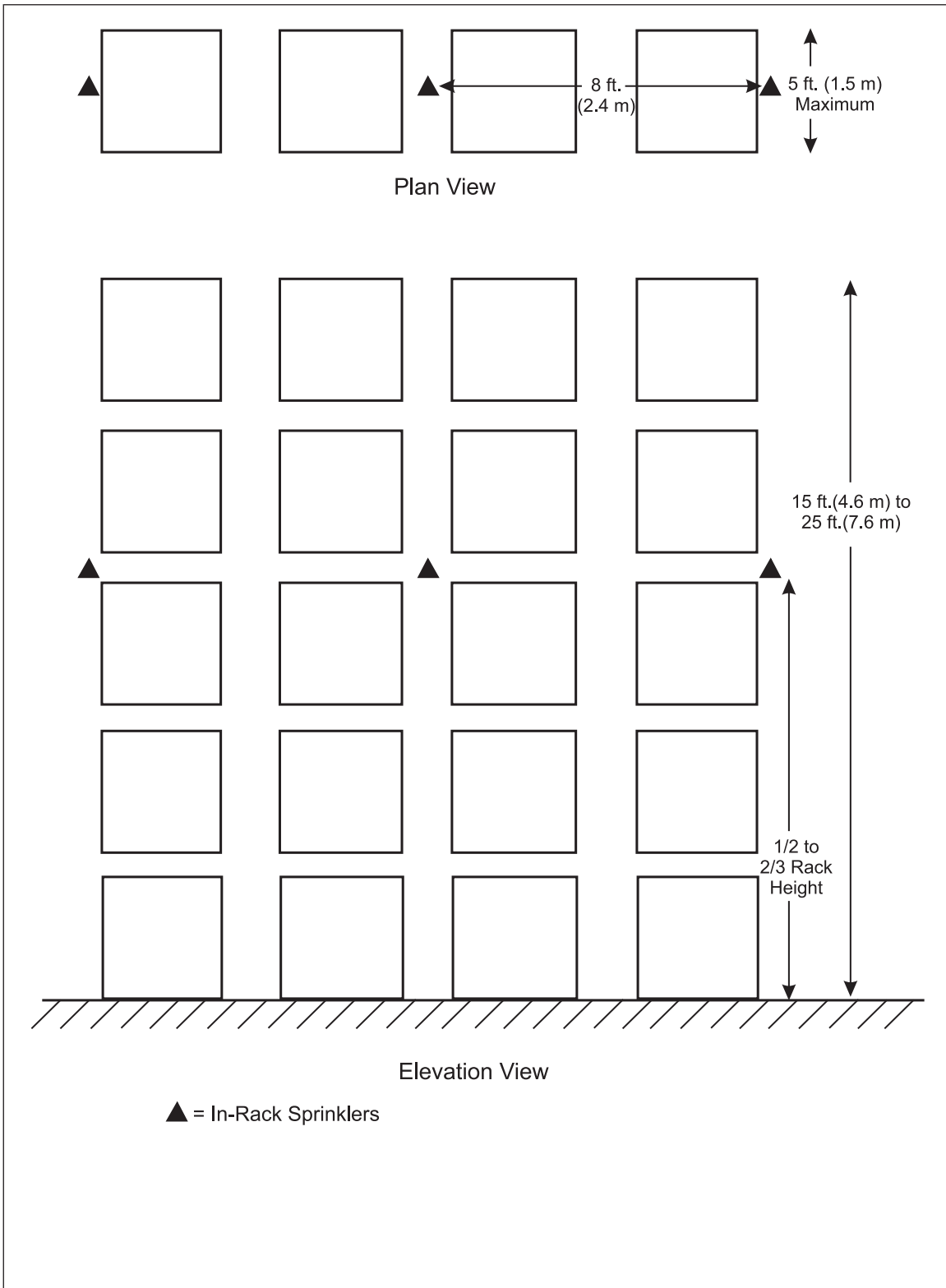

Fig. D.2.1.44. Single-row rack storage of water-miscible liquids

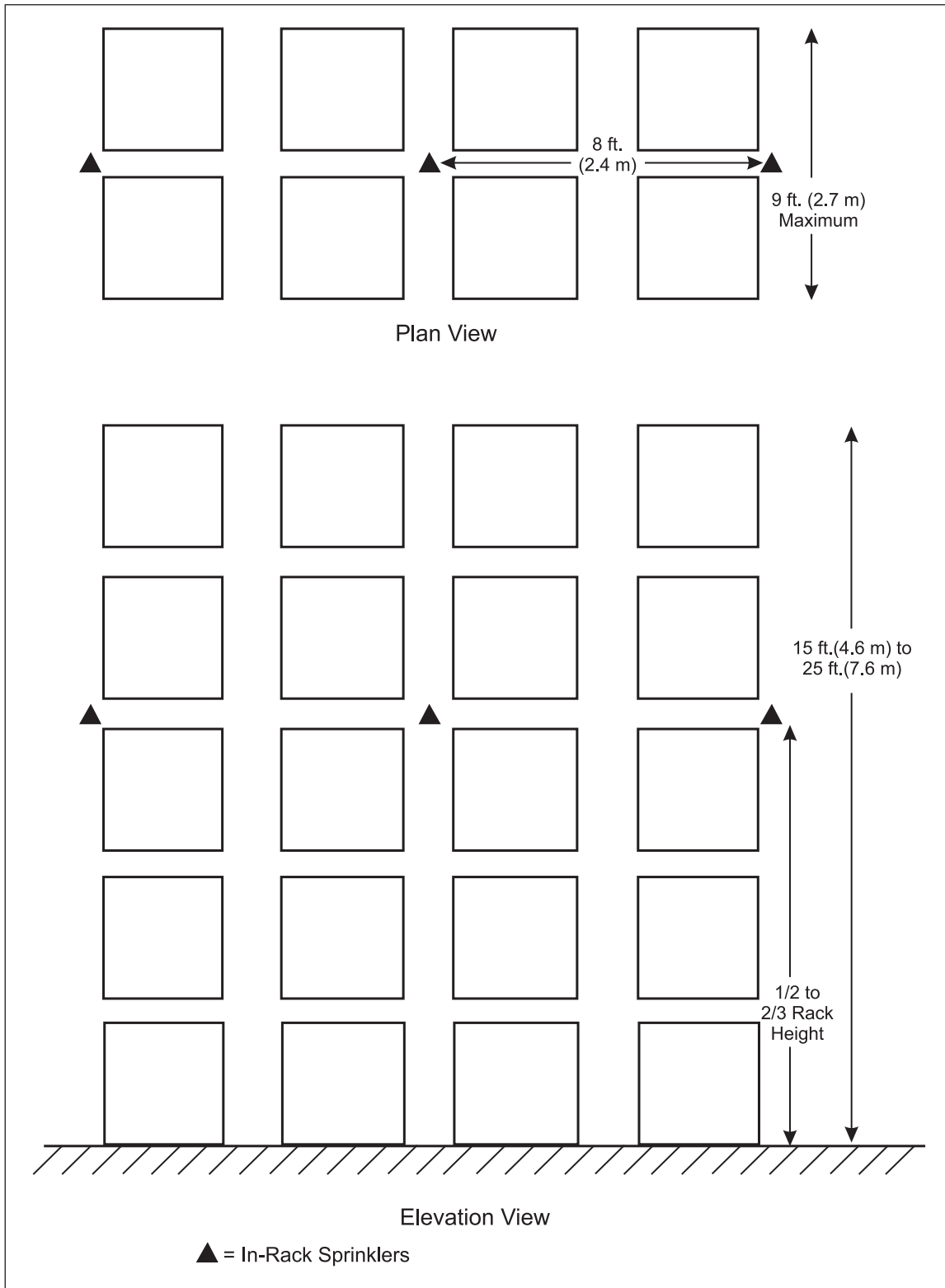

Fig. D.2.1.45. Double-row rack storage of water-miscible liquids

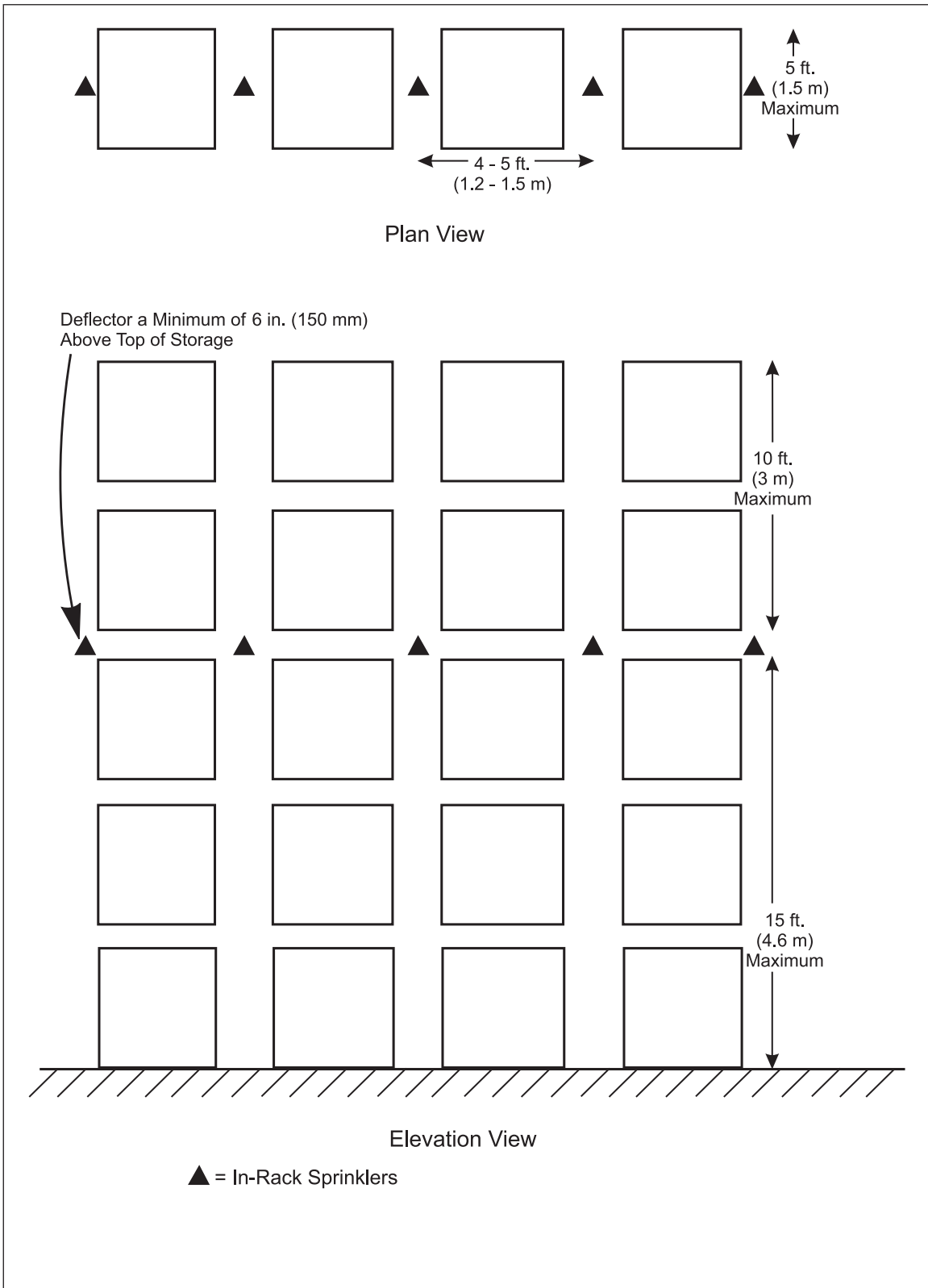

Fig. D.2.1.46. Single-row rack storage of Group 3 water-miscible liquids

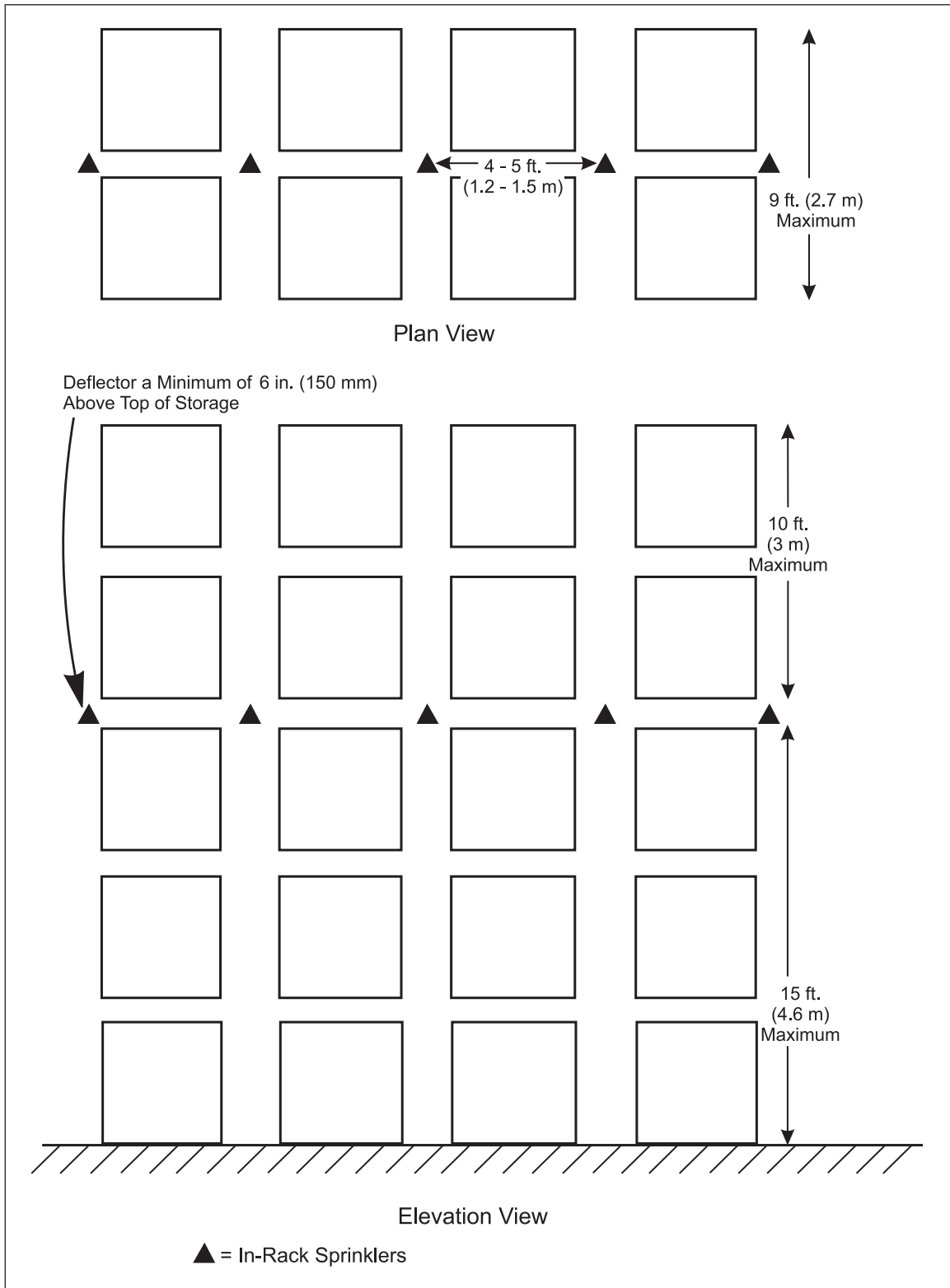

Fig. D.2.1.47. Double-row rack storage of Group 3 water-miscible liquids

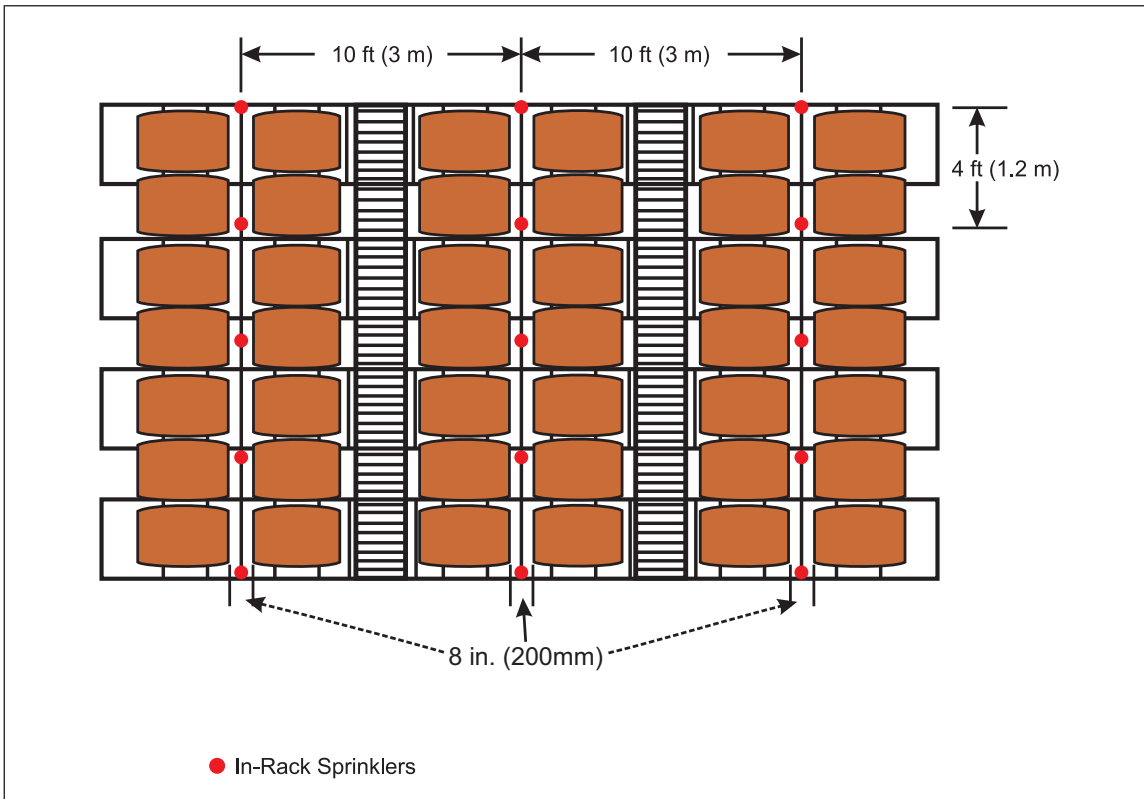

Fig. D.2.1.48. In-rack sprinkler layout for distilled spirits in wooden barrels (plan view)

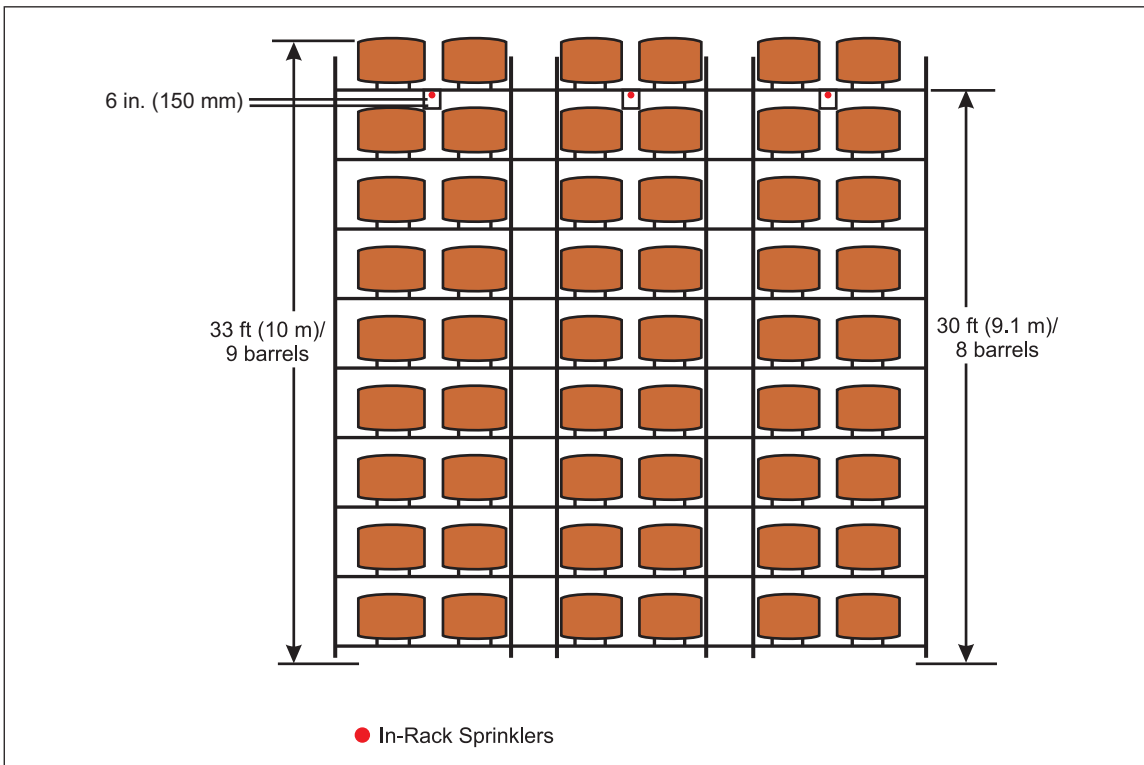

Fig. D.2.1.49. In-rack sprinkler layout for distilled spirits in wooden barrels (elevation view)

D.2.2 Fire Protection Schemes

D.2.2.1 Fire Protection Scheme A

D.2.2.1.1 Provide plywood (minimum 3/8 in. [10 mm]) or sheet metal (minimum 22 ga. [0.7 mm]) barriers and in-rack sprinklers installed in accordance with Figures D.2.2.1.1, D.2.2.1.2, D.2.2.1.3, and D.2.2.1.4 depending on the recommended rack type for the storage.

1. Use a maximum vertical spacing of 12 ft (3.7 m) between barriers.
2. Do not store ignitable liquids above the top barrier level.
3. Design barriers without gaps in longitudinal flue spaces. A maximum gap of 3 in. (75 mm) between each barrier is permitted at rack uprights (transverse flue) for single and double row racks. Avoid gaps for multi row racks.

D.2.2.1.2 Install FM Approved K8.0 (K115) or K11.2 (K160), 165°F (74°C) rated, quick response in-rack sprinklers below each barrier level.

1. Design the in-rack sprinklers to provide a minimum flow of 57 gpm (216 L/min) out of the hydraulically most remote six (6) sprinklers (e.g., three face sprinklers and three flue sprinklers in a DRR) if one barrier level is provided, or the most remote eight (8) sprinklers (e.g., two face sprinklers and two flue sprinklers on two levels in a DRR) if two or more barrier levels are provided.
2. Locate face sprinklers within 6 in. (150 mm) of the rack face.

D.2.2.1.3 For the liquid-container combinations provided in Table D.2.2.1.3, provide the following:

1. If there are adjacent bays of rack arrays not dedicated to liquid storage, extend the barrier and in-rack sprinkler protection at least one rack bay, approximately 8 ft (2.4 m) beyond the liquid storage.
2. Do not include ceiling sprinkler demand in the hydraulic calculations for in-rack sprinklers. Calculate the water demand at point of supply separately for in-rack and ceiling sprinklers. Provide a 250 gpm (946 L/min) hose stream allowance in the hydraulic calculations for the in-rack sprinkler protection. Provide the combined fire protection water demand for a 1-hour duration.
3. Design ceiling sprinklers to protect the surrounding occupancy. Provide a minimum ceiling sprinkler design of 0.2 gpm/ft² (8 mm/min). If the liquid storage does not extend to the full height of the rack, protect the other commodities stored above the barrier in accordance with appropriate data sheets as if the entire rack height were filled with that commodity. If in-rack sprinklers are required for the other commodities, each level of barrier and in-rack sprinklers can be given credit as a level of in-rack sprinklers.

Table D.2.2.1.3. Liquid-Container Combinations for Use With Scheme A Without Balancing the Ceiling and In-rack Designs

Flash Point/ Liquid Type	Container Size	Container Type
Any	≤6.5 gal (25 L)	Metal
<200°F (93°C)	≤2 oz (60 ml)	Plastic/glass
Very high flash point	≤60 gal (230 L)	Plastic
≥200°F (93°C)	≤6.5 gal (25 L)	Plastic/glass
Groups 1 and 2 water miscible	≤1 gal (3.8 L)	Plastic/glass
Groups 3 and 4 water miscible	≤6.5 gal (25 L)	Plastic/glass

D.2.2.1.4 For the liquid-container combinations provided in Table D.2.2.1.4 provide the following:

1. If all racks in the cutoff room are not protected with the same level of protection, extend the barrier and in-rack sprinkler protection at least two rack bays, approximately 16 ft (4.9 m) beyond the liquid storage and to racks on each side of the storage.
2. Balance the ceiling sprinkler demand provided in the appropriate protection table and the in-rack sprinkler demand at the point of connection. Provide a 500 gpm (1890 L/min) hose stream allowance. Provide the fire protection water demand for a 1-hour duration.
3. Design ceiling sprinklers in accordance with the appropriate protection table.

Table D.2.2.1.4. Liquid-Container Combinations for Use With Scheme A Where Balancing the Ceiling and In-rack Designs is Needed

Flash Point/ Liquid Type	Container Size	Container Type
Group 1 & 2 water miscible	≤6.5 gal (25 L)	Plastic/glass

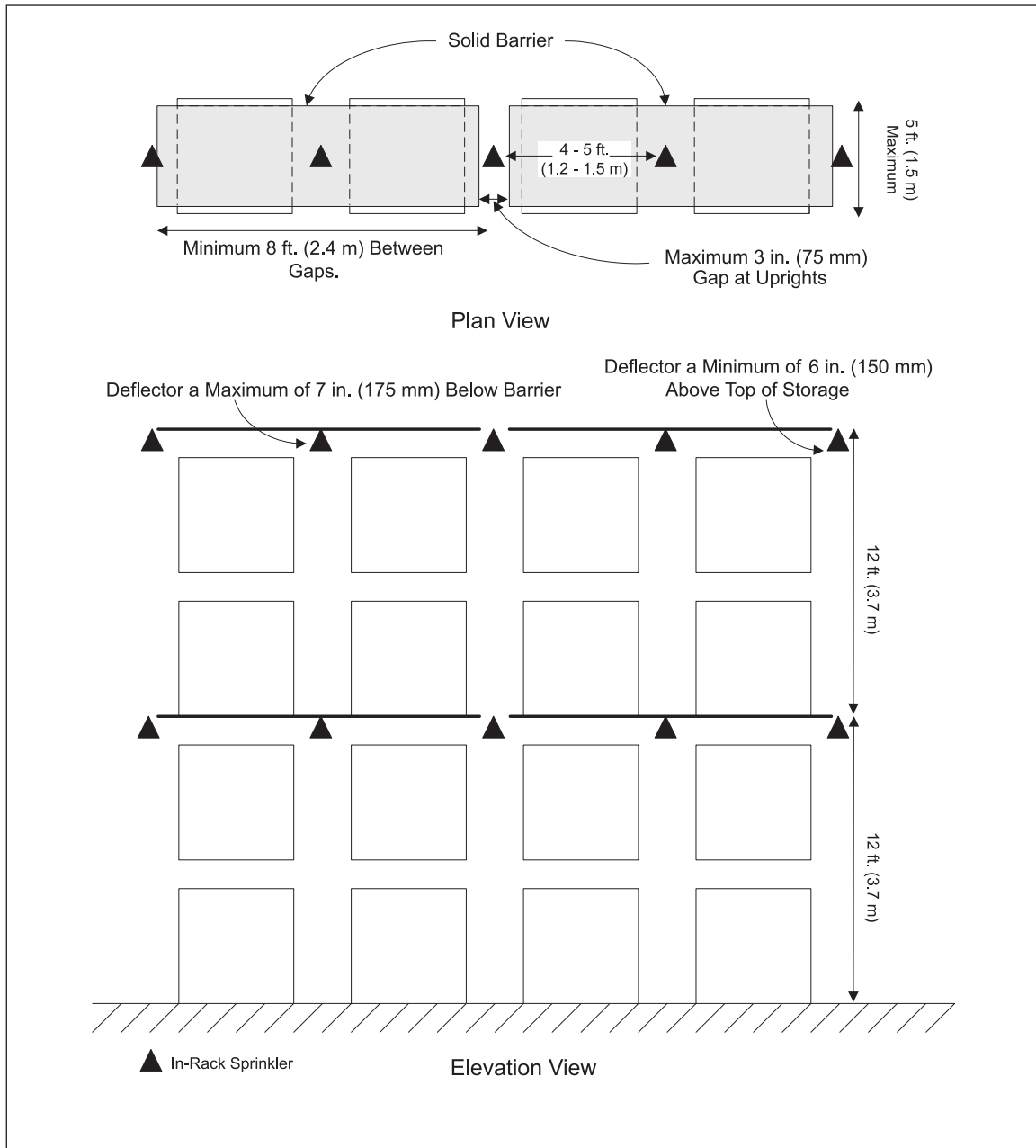

Fig. D.2.2.1.1. Single-row rack sprinkler layout: fire protection scheme A

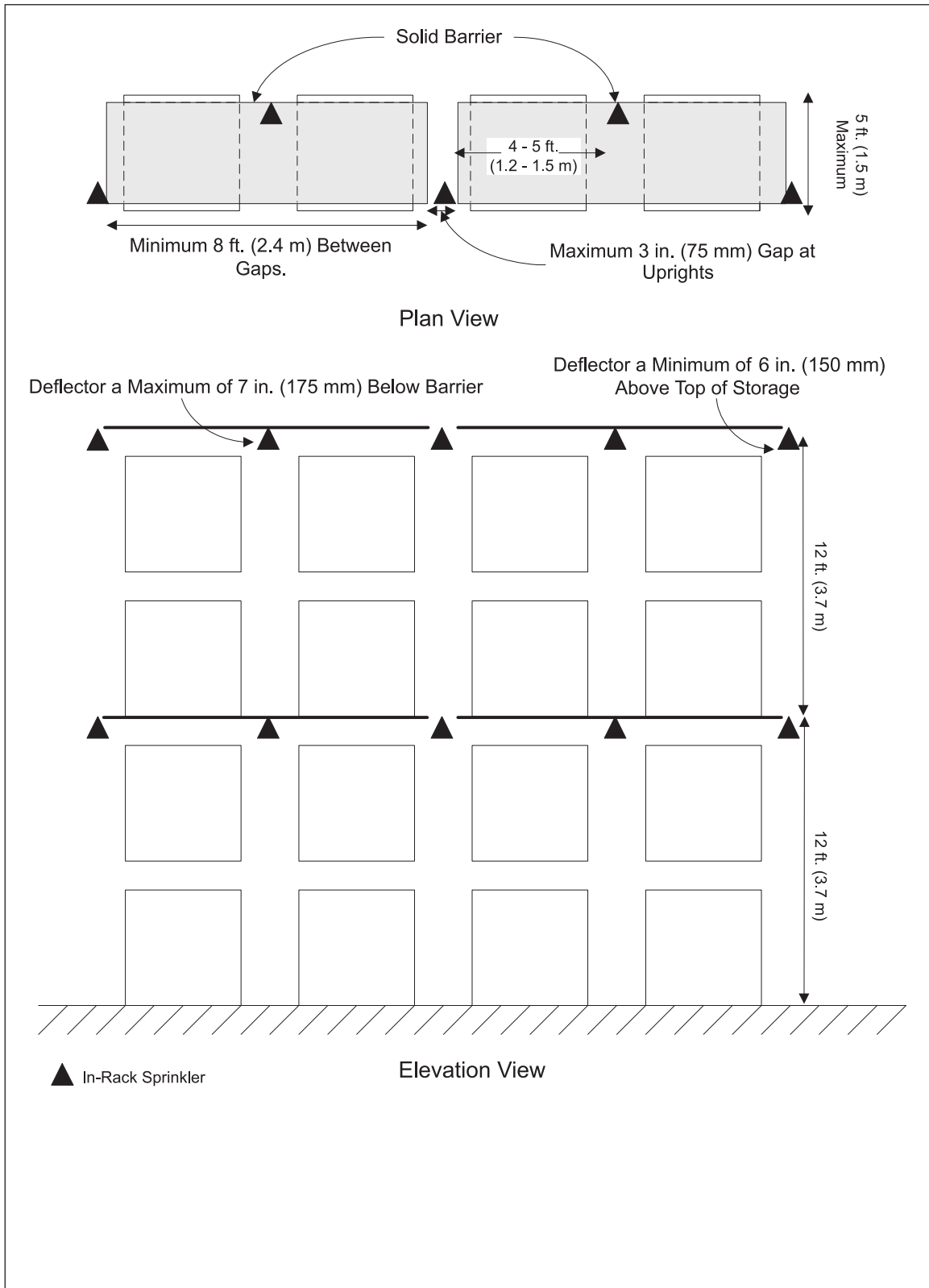

Fig. D.2.2.1.2. Single-row rack sprinkler layout: fire protection scheme A

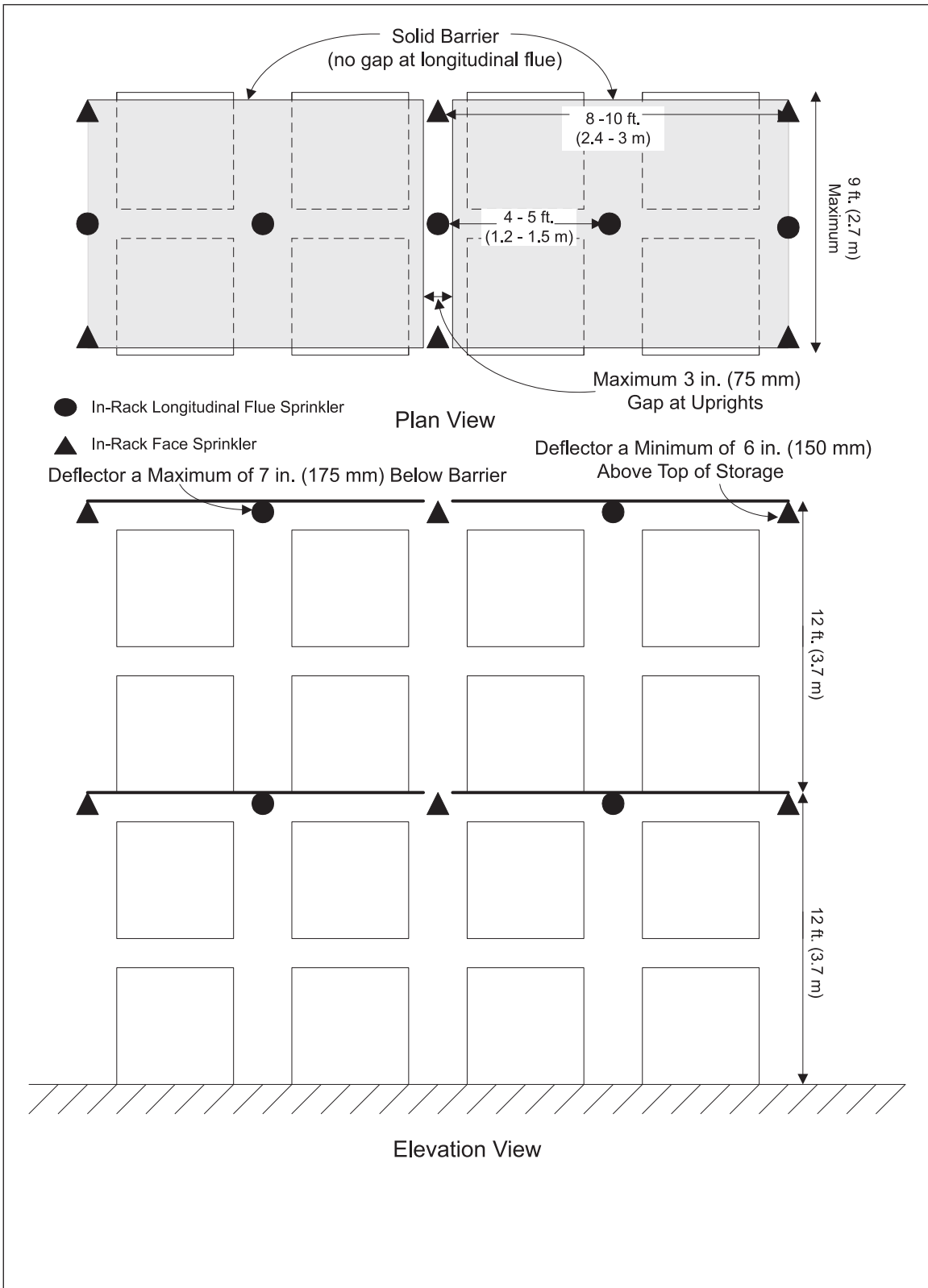

Fig. D.2.2.1.3. Double-row rack sprinkler layout: fire protection scheme A

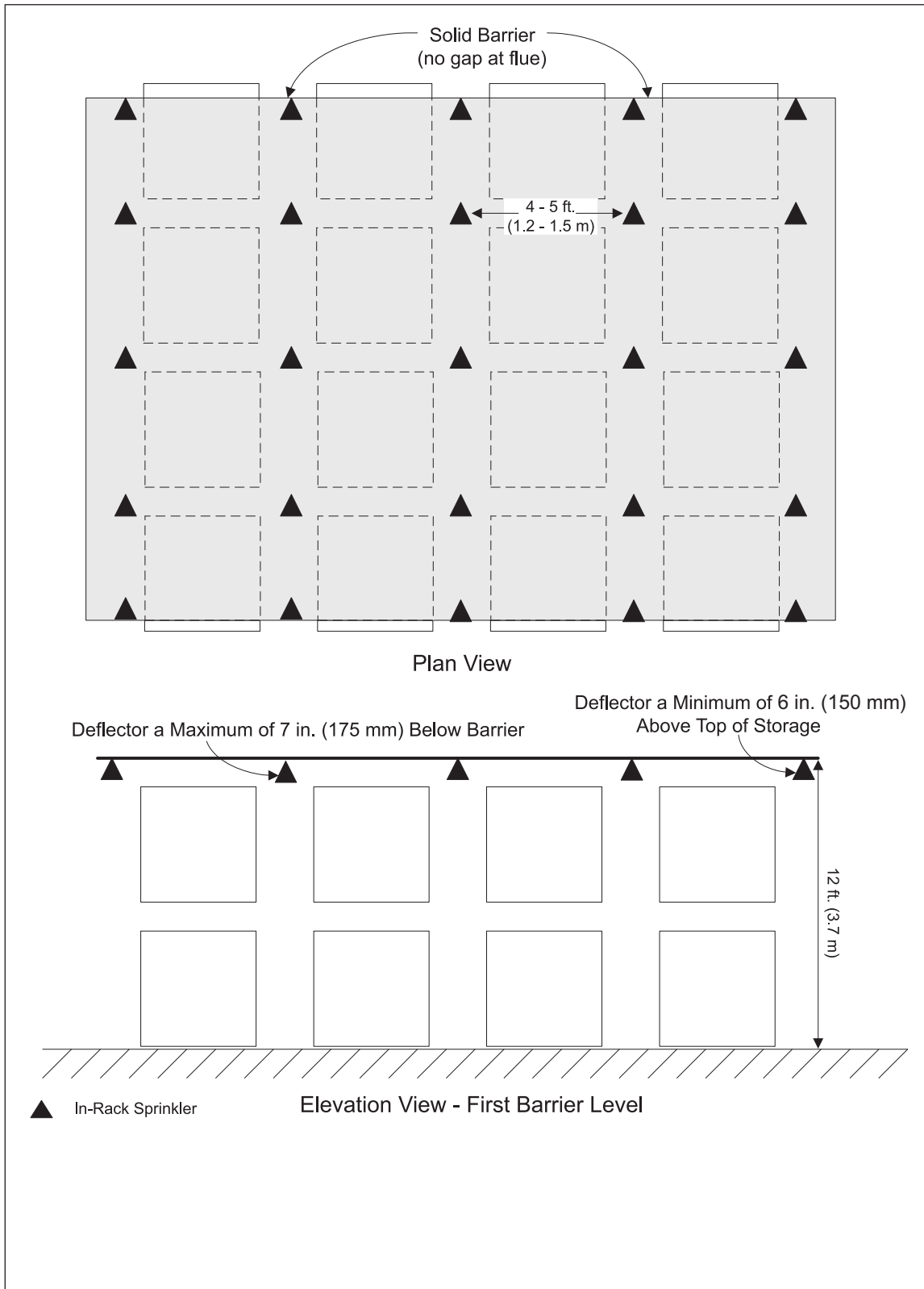

Fig. D.2.2.1.4. Multiple-row rack sprinkler layout: fire protection scheme A

D.2.2.2 Fire Protection Scheme B

D.2.2.2.1 Install in-rack sprinklers in accordance with Figures D.2.2.2.1, D.2.2.2.2, D.2.2.2.3, D.2.2.2.4. Stagger face-sprinklers for the double-row racks vertically.

D.2.2.2.2 Install FM Approved K8.0 (K115) or K11.2 (K160), 165°F (74°C) rated, quick response in-rack sprinklers.

1. Design the in-rack sprinklers to provide a minimum flow of 30 gpm (114 L/min) out of the hydraulically most remote 8 sprinklers (e.g. four face sprinklers and four flue sprinkles in a DRR) if one level of in-rack sprinklers is provided, or the most remote 14 sprinklers (four face sprinklers and three flue sprinklers on two levels in a DRR) if two or more levels are provided.

2. Locate face sprinklers within 6 in. (150 mm) of the rack face.

D.2.2.2.3 If there are adjacent bays of rack storage not dedicated to liquid storage, extend the in-rack sprinkler protection by at least one rack bay, approximately 8 ft (2.4 m) beyond the liquid storage.

D.2.2.2.4 Balance the ceiling and in-rack demands at the point of connection to the water supply. Provide a 500 gpm (1890 L/min) hose stream allowance in the hydraulic calculations. Provide the combined fire protection water demand for a 1-hour duration.

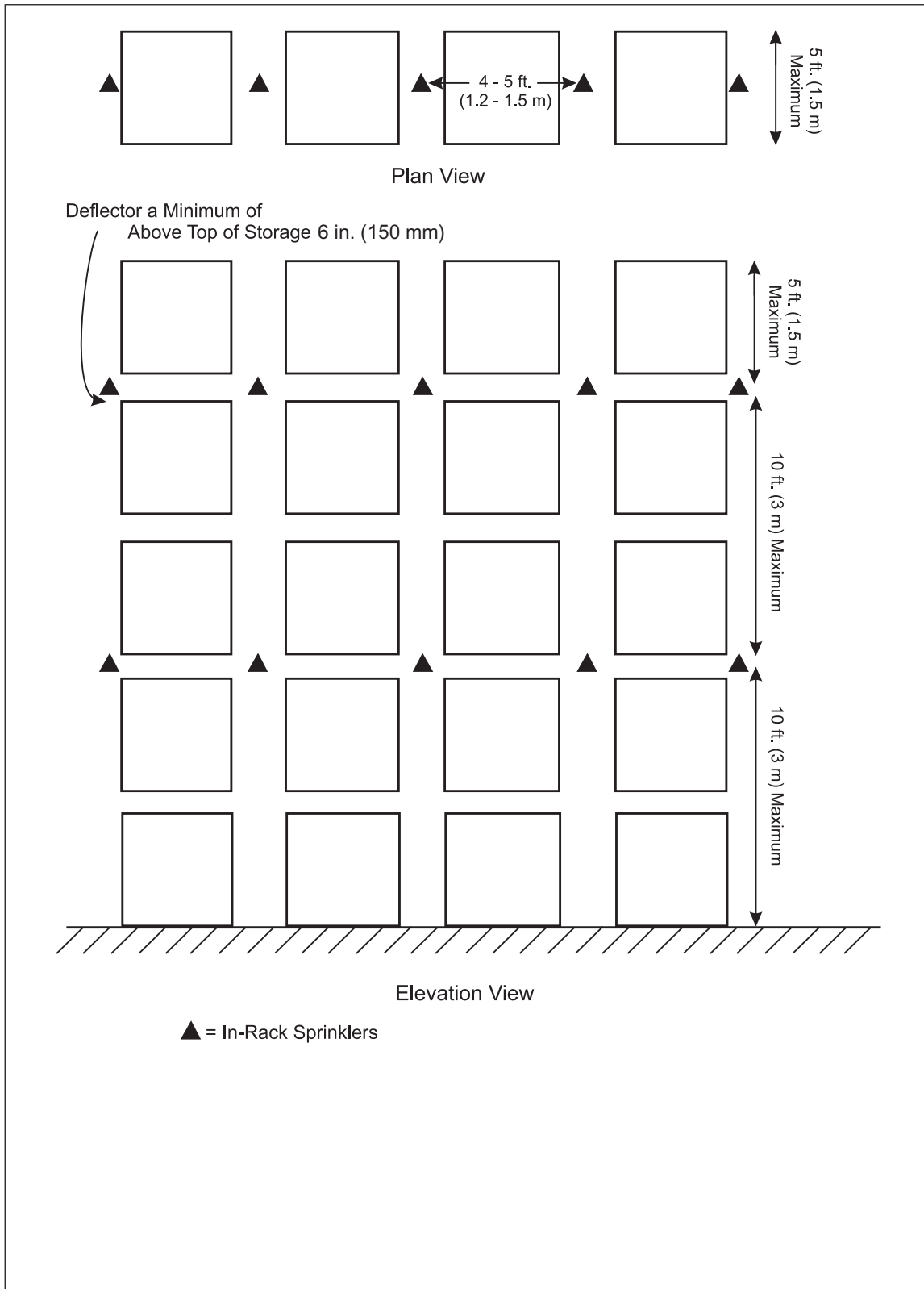

Fig. D.2.2.2.1. Single-row rack sprinkler layout: fire protection scheme B

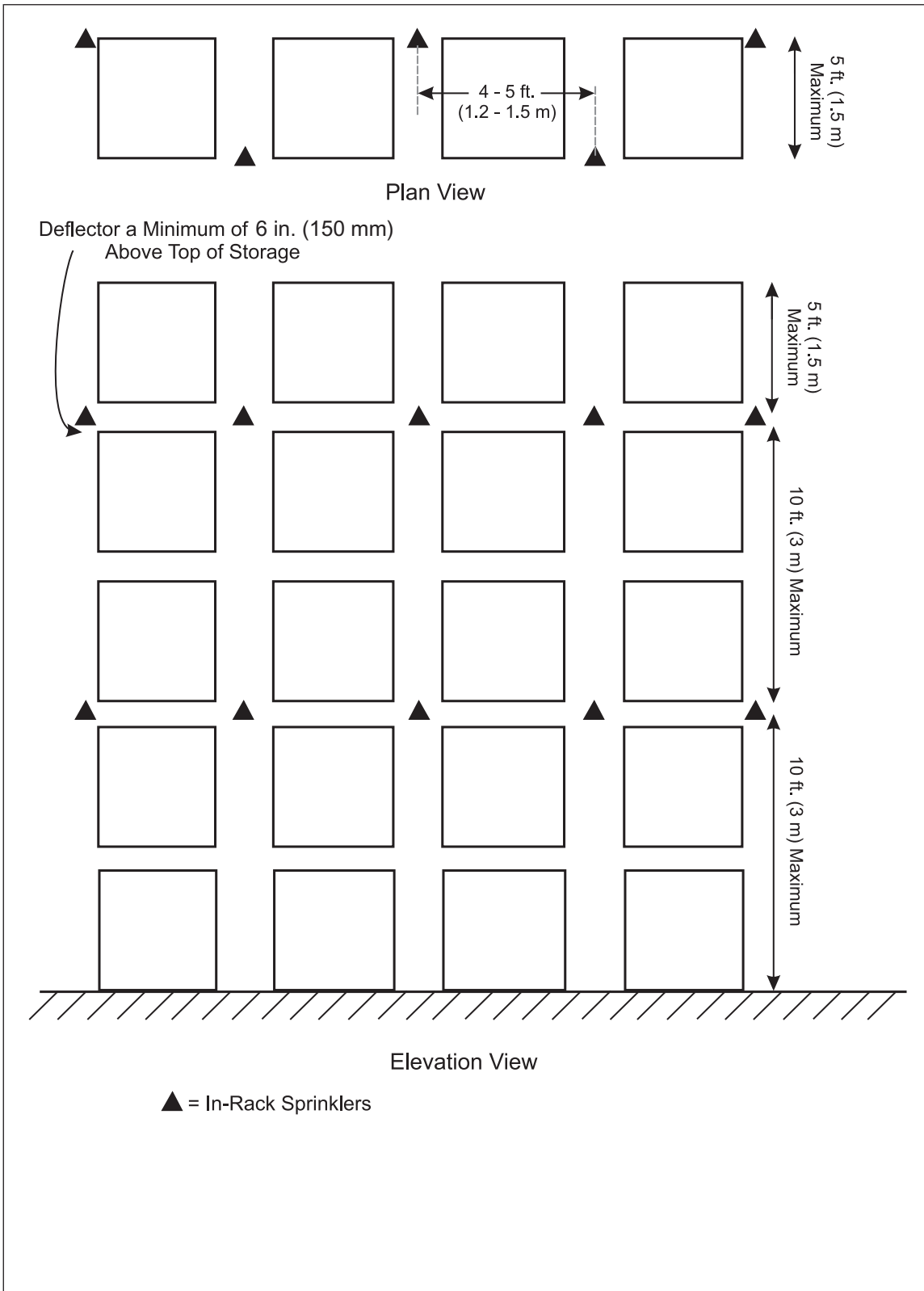

Fig. D.2.2.2.2. Single-row rack sprinkler layout: fire protection scheme B

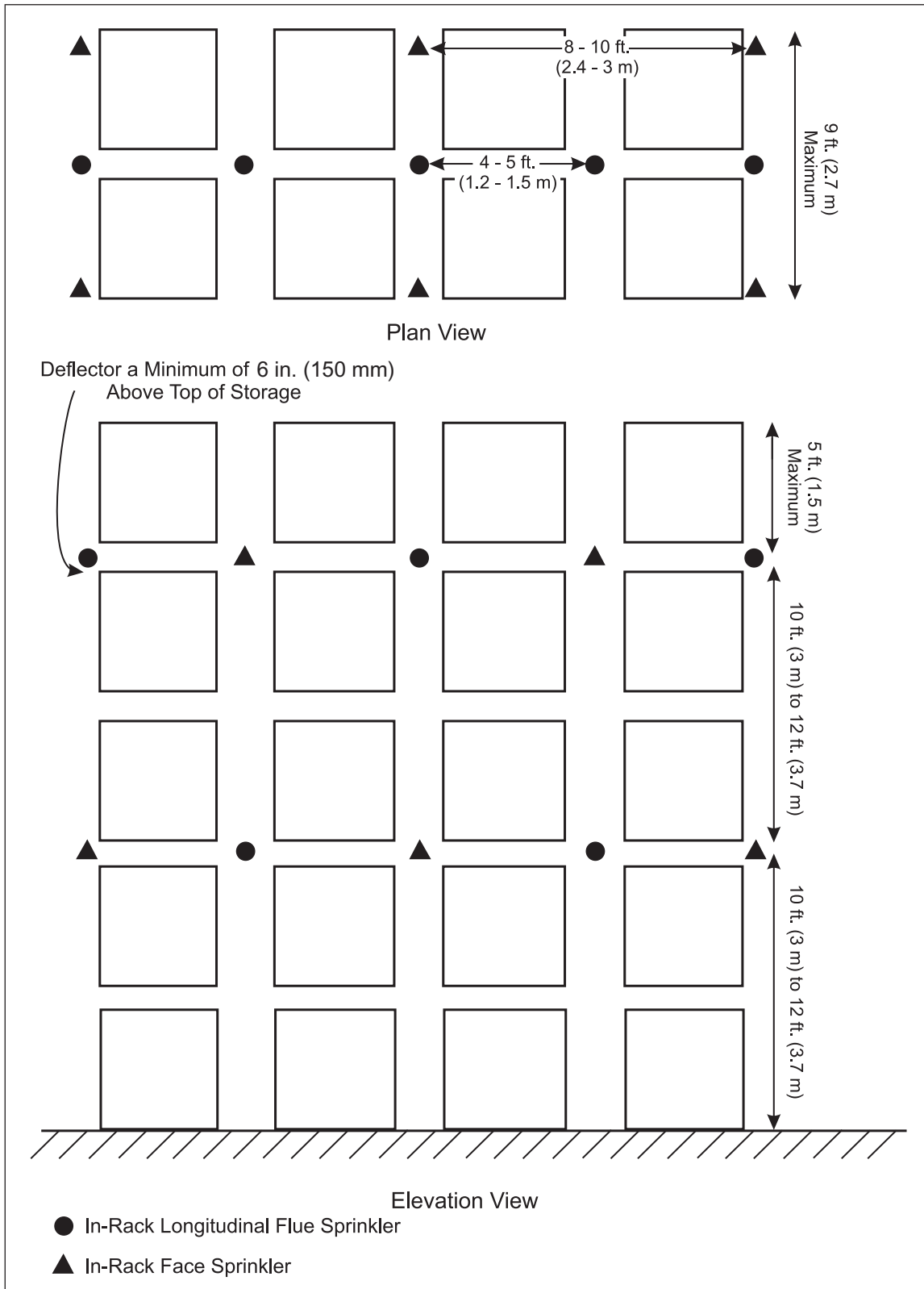

Fig. D.2.2.2.3. Double-row rack sprinkler layout: fire protection scheme B

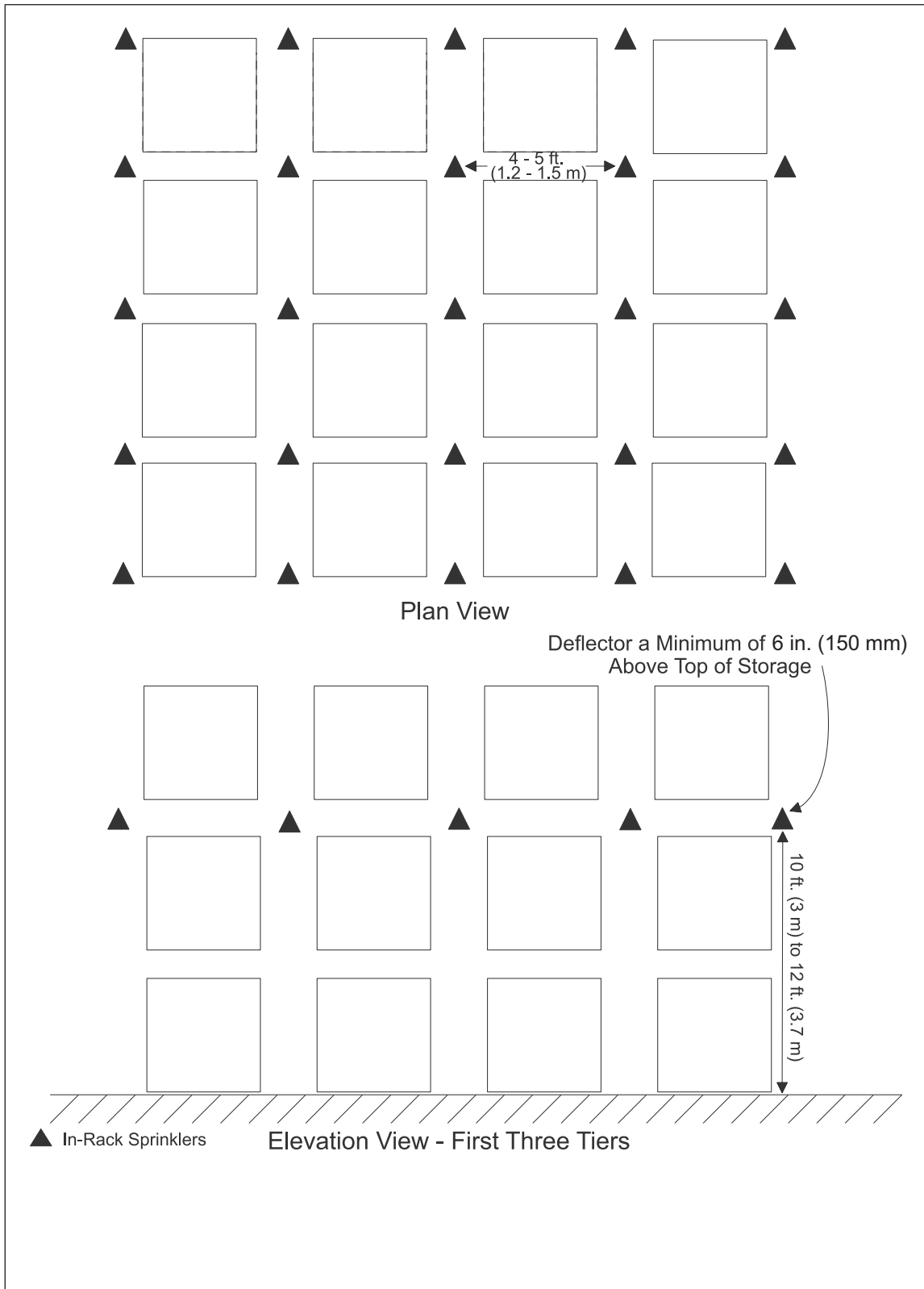

Fig. D.2.2.2.4. Multiple-row rack sprinkler layout: fire protection scheme B

D.2.2.3 Fire Protection Scheme C

D.2.2.3.1 Install in-rack sprinklers in accordance with Figures D.2.2.3.1, D.2.2.3.2, D.2.2.3.3.

D.2.2.3.2 For cartoned 48 oz (1.4 l) containers stored in 35 ft (10.7 m) high double or single row racks in a 40 ft (12.2 m) high building:

D.2.2.3.2.1 Provide a single level of in-racks sprinklers located at approximately the 15 ft (4.6 m) vertical level with the horizontal spacing shown in Figures D.2.2.3.1 or D.2.2.3.3.

D.2.2.3.3 Install FM Approved K8.0 (K115) or K11.2 (K160), 165°F (74°C) rated, quick response in-rack sprinklers.

D.2.2.3.4 Design the in-rack sprinklers to provide a minimum flow of 30 gpm (114 L/min) out of the hydraulically most remote eight sprinklers if one level of in-rack sprinklers is provided, or the most remote 14 sprinklers (7 on two levels) if two or more levels are provided.

D.2.2.3.5 If there are adjacent bays of rack storage not dedicated to liquid storage, extend the in-rack sprinkler protection by at least one rack bay, approximately 8 ft (2.4 m) beyond the liquid storage.

D.2.2.3.6 Balance the ceiling and in-rack demands at the point of connection to the water supply.

D.2.2.3.7 Provide a 500 gpm (1890 L/min) hose stream allowance in the hydraulic calculations.

D.2.2.3.8 Provide the combined fire protection water demand for a 1-hour duration.

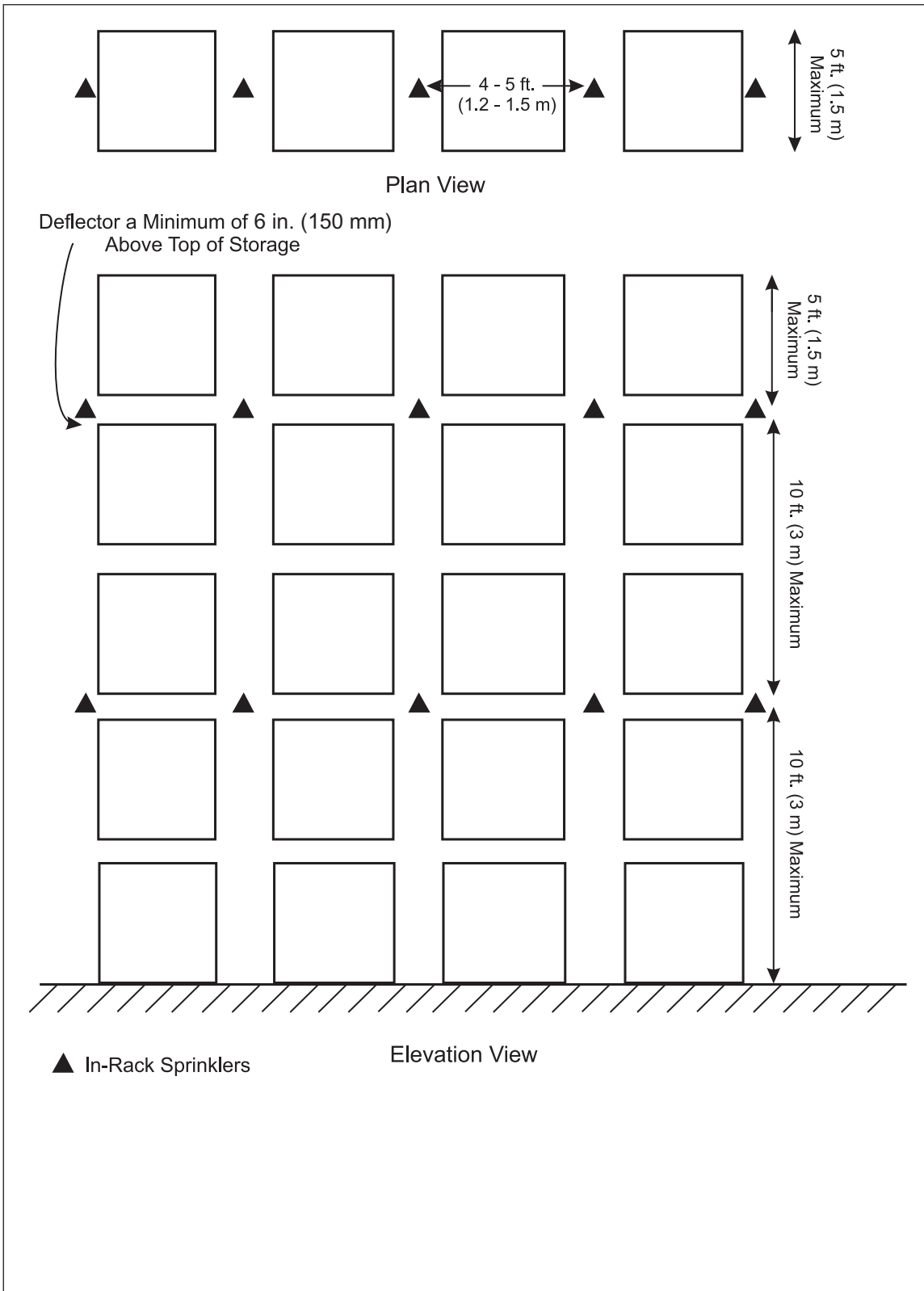

Fig. D.2.2.3.1. Single-row rack sprinkler layout: fire protection scheme C

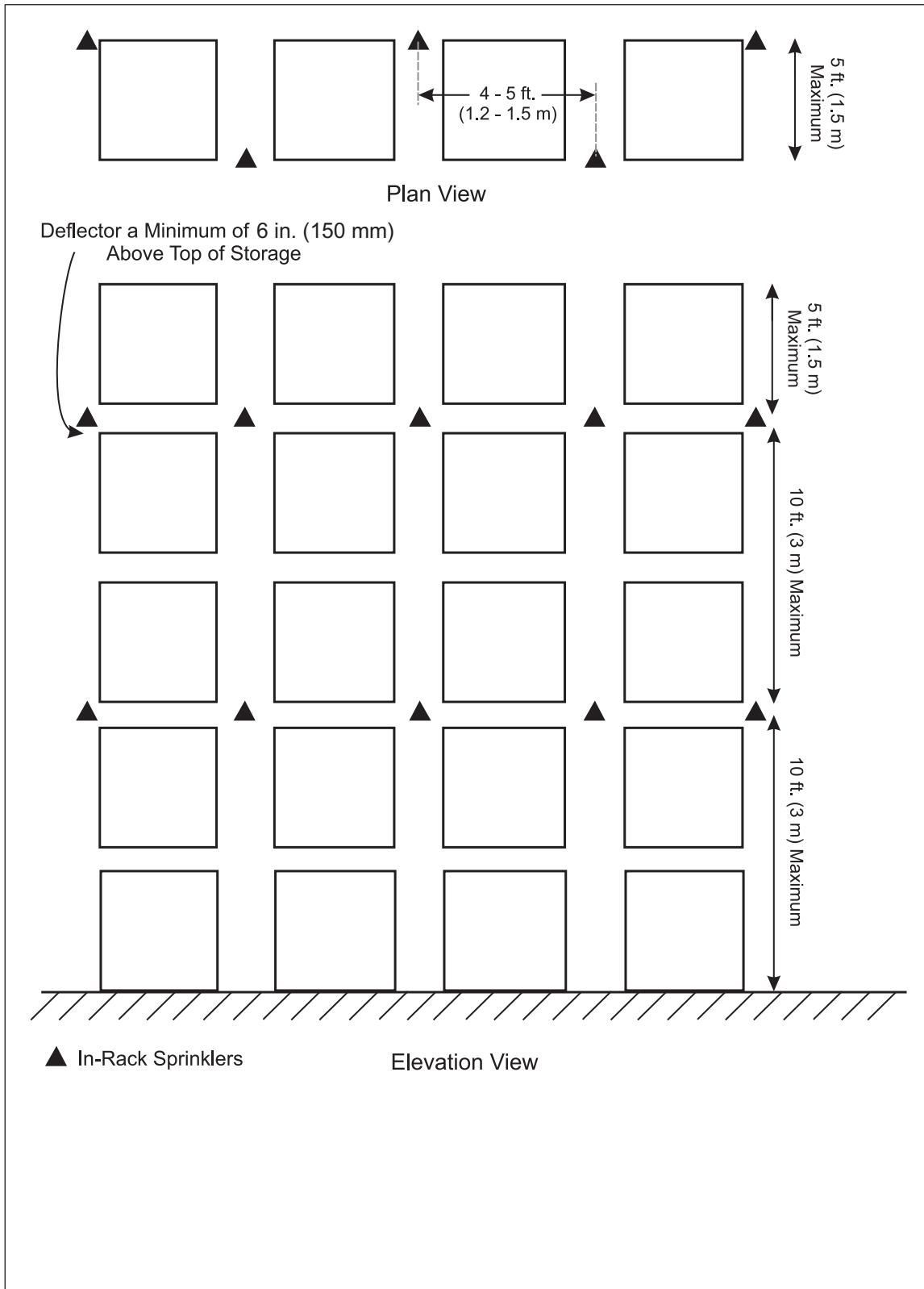

Fig. D.2.2.3.2. Single-row rack sprinkler layout: fire protection scheme C

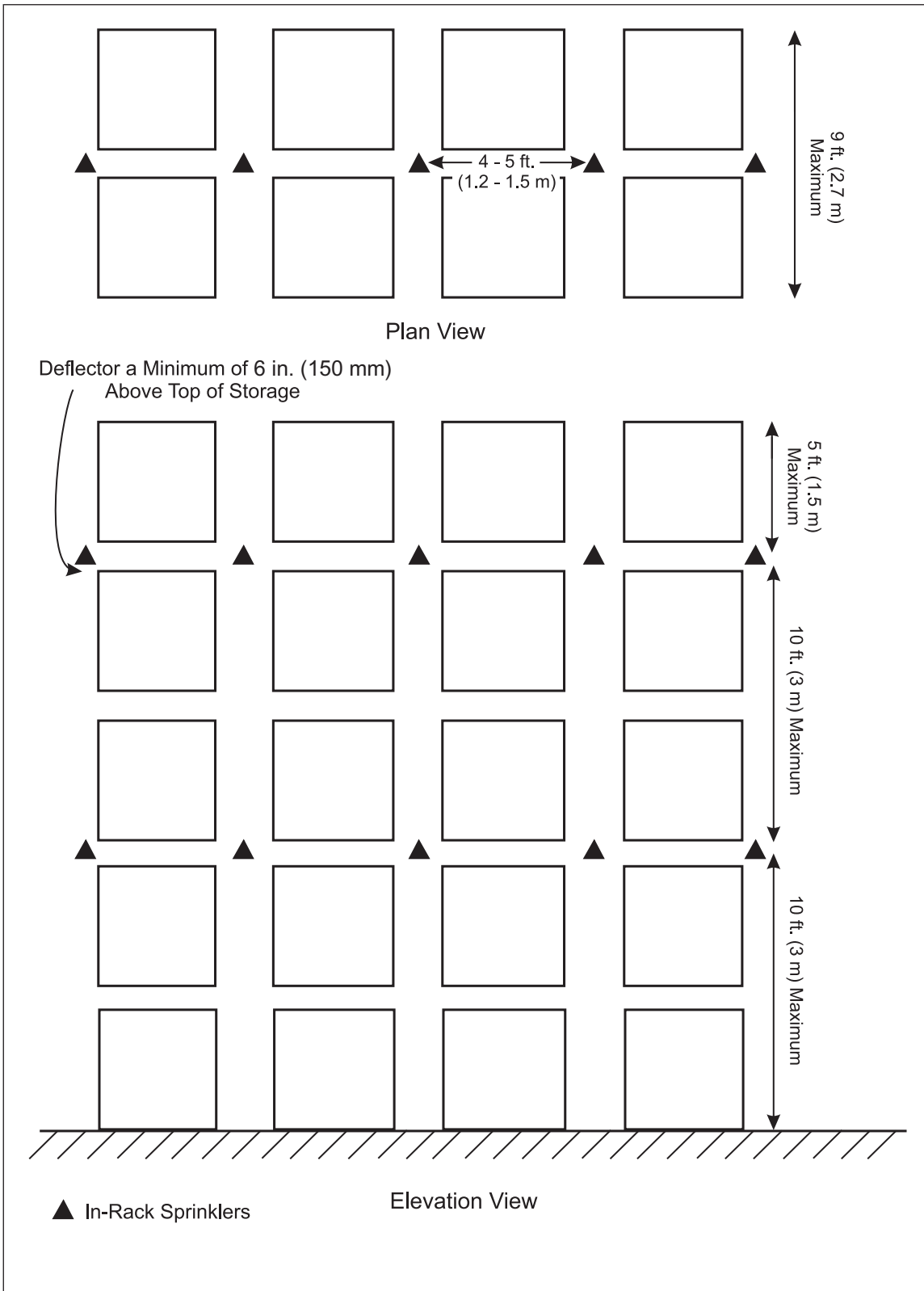

Fig. D.2.2.3.3. Double-row rack sprinkler layout: fire protection scheme C

D.2.2.4 Fire Protection Scheme D

D.2.2.4.1 Provide plywood (minimum 3/8 in. [10 mm]) or sheet metal (minimum 22 ga. [0.7 mm]) barriers and in-rack sprinklers installed in accordance with Figures D.2.2.4.1, D.2.2.4.2, D.2.2.4.3 depending on the rack type.

1. Use a maximum vertical barrier spacing of 6 ft (1.8 m).
2. Design barriers without gaps in longitudinal flue spaces. A maximum gap of 3 in. (75 mm) between each barrier is permitted at rack uprights (transverse flue) for single and double row racks. Avoid gaps for multi row racks.
3. Do not store ignitable liquids above the top barrier level.

D.2.2.4.2 Design the in-rack sprinklers based on the container size and liquid type provided below in D.2.2.4.3, D.2.2.4.4, D.2.2.4.5 and D.2.2.4.6.

1. Install FM Approved K8.0 (K115) or K11.2 (K160), 165°F (74°C) rated, quick response in-rack sprinklers below each barrier level.
2. Locate face sprinklers within 6 in. (150 mm) of the rack face.

D.2.2.4.3 For liquids with a flash point at or above 200°F (93°C) in composite IBCs or alcohols in composite IBCs, provide the following:

1. This protection approach has only been tested for rack storage. Testing on palletized storage arrays has shown that composite IBCs cannot be adequately protected using ceiling-only sprinkler protection. Since pallet loads are transported into and out of racks and a fire involving even a single IBC could damage the building, only use this approach in well-cutoff rooms.
2. Limit storage to the bottom tier of the rack.
3. Design the in-rack sprinklers to provide a minimum flow of 60 gpm (227 L/min) out of the hydraulically most remote eight (8) sprinklers (e.g. four face sprinklers and four flue sprinklers in a DRR). If there are additional barrier levels above the first tier (e.g., protecting smaller containers with Scheme A), design the total in-rack system to supply the most remote ten (10) sprinklers (e.g. five face sprinklers and five flue sprinklers on two levels in a DRR).
4. Protect all racks in the cutoff room with the same level of protection. Arrange the room to ensure there will not be any on-floor storage. Storage is permitted above the first rack tier but is limited to products that can be protected by Scheme A. Protection above the first tier can either continue with Scheme D for the full height of the rack or use Scheme A for the full height of the rack.
5. Balance the ceiling sprinkler demand and the in-rack sprinkler demand at the point of connection. Provide a 500 gpm (1890 L/min) hose stream allowance. Provide the fire protection water demand for a 1-hour duration.

D.2.2.4.4 For water-miscible liquids in plastic containers of 60 gal (230 L) or less, provide the following:

1. This protection approach has only been tested for rack storage. It is unknown if palletized storage can be protected with a ceiling-based sprinkler system. Since pallet loads are transported into and out of racks and a fire involving even a single pallet load could damage the building, this approach should only be used in well-cutoff rooms.
2. Design the in-rack sprinklers to provide a minimum flow of 45 gpm (170 L/min) out of the hydraulically most remote eight (8) sprinklers (e.g., four face sprinklers and four flue sprinklers in a DRR) if one barrier level, or the most remote five (5) sprinklers per tier up to twenty (20) if two or more barrier levels are provided.
3. Protect all racks in the cutoff room with the same level of protection. Arrange the room to ensure there will not be any on-floor storage.
4. Balance the ceiling sprinkler demand and the in-rack sprinkler demand at the point of connection. Provide a 500 gpm (1890 L/min) hose stream allowance. Provide the fire protection water demand for a 1-hour duration.

D.2.2.4.5 For liquids with a flash point below 200°F (93°C) in plastic containers of 1 gal (4 L) or less, provide the following:

1. This protection approach has only been tested for rack storage. It is unknown if palletized storage can be protected with a ceiling-based foam-water sprinkler system. Since pallet loads are transported into and out of racks and a fire involving even a single pallet load could damage the building, this approach should only be used in well-cutoff rooms.
2. Design the in-rack sprinklers to provide a minimum flow of 60 gpm (227 L/min) out of the hydraulically most remote six (6) sprinklers (e.g., three face sprinklers and three flue sprinklers in a DRR) if one barrier level, or the most remote eight (8) sprinklers (e.g., four face sprinklers and four flue sprinklers on two levels in a DRR) if two or more barrier levels are provided.
3. Protect all racks in the cutoff room with the same level of protection. Arrange the room to ensure there will not be any on-floor storage. Storage is permitted above the fourth rack tier but is limited to products that can be protected by Scheme A. Protection above the first tier can either continue with Scheme D for the full height of the rack or use Scheme A for the full height of the rack.
4. Balance the ceiling sprinkler demand and the in-rack sprinkler demand at the point of connection.
5. Provide a 500 gpm (1900 L/min) hose stream allowance. Provide the fire protection water demand for a 1-hour duration.
6. Provide an FM Approved foam-water sprinkler system for the ceiling and in-rack protection.

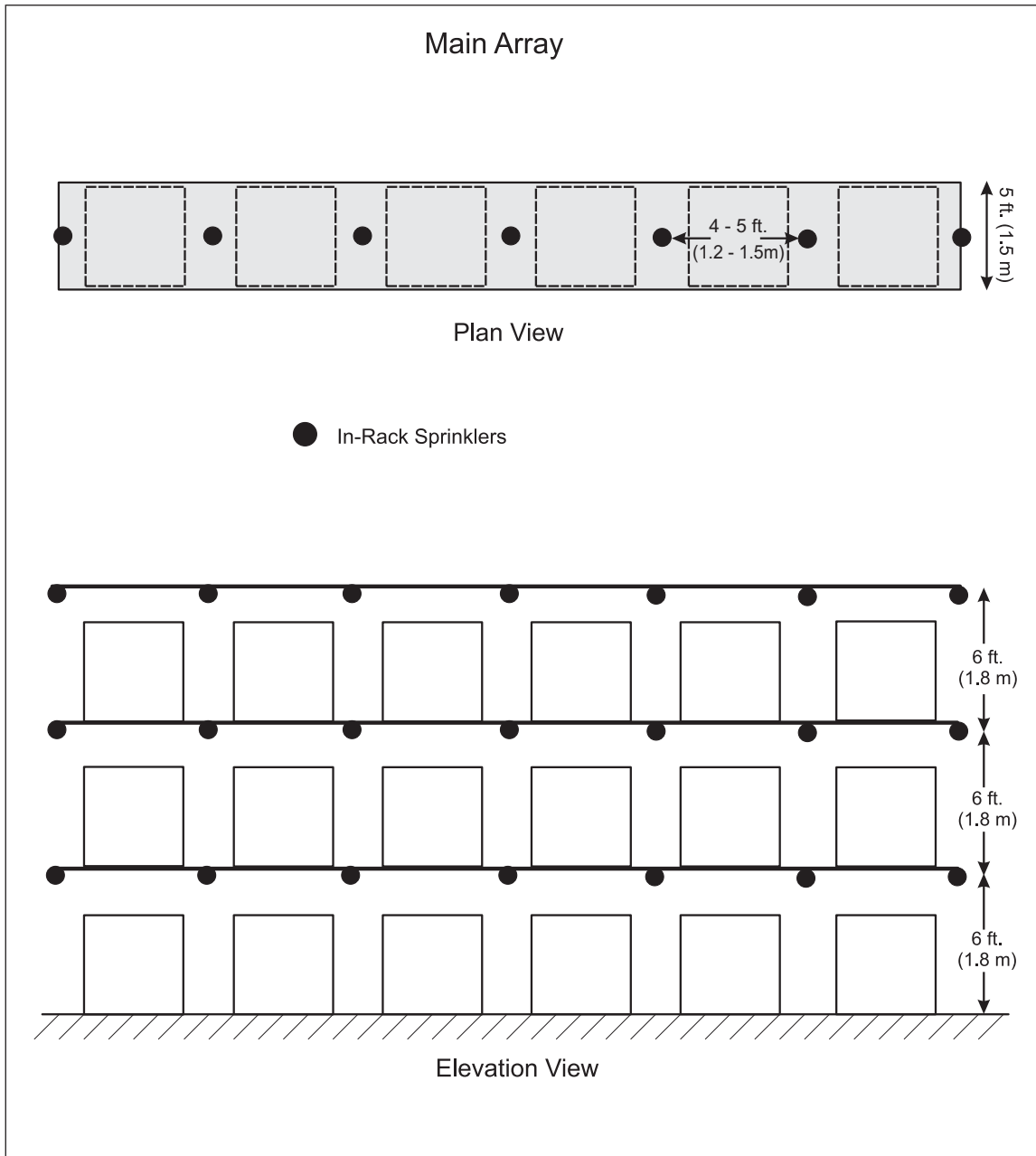

Fig. D.2.2.4.1. Single-row rack sprinkler layout: fire protection scheme D

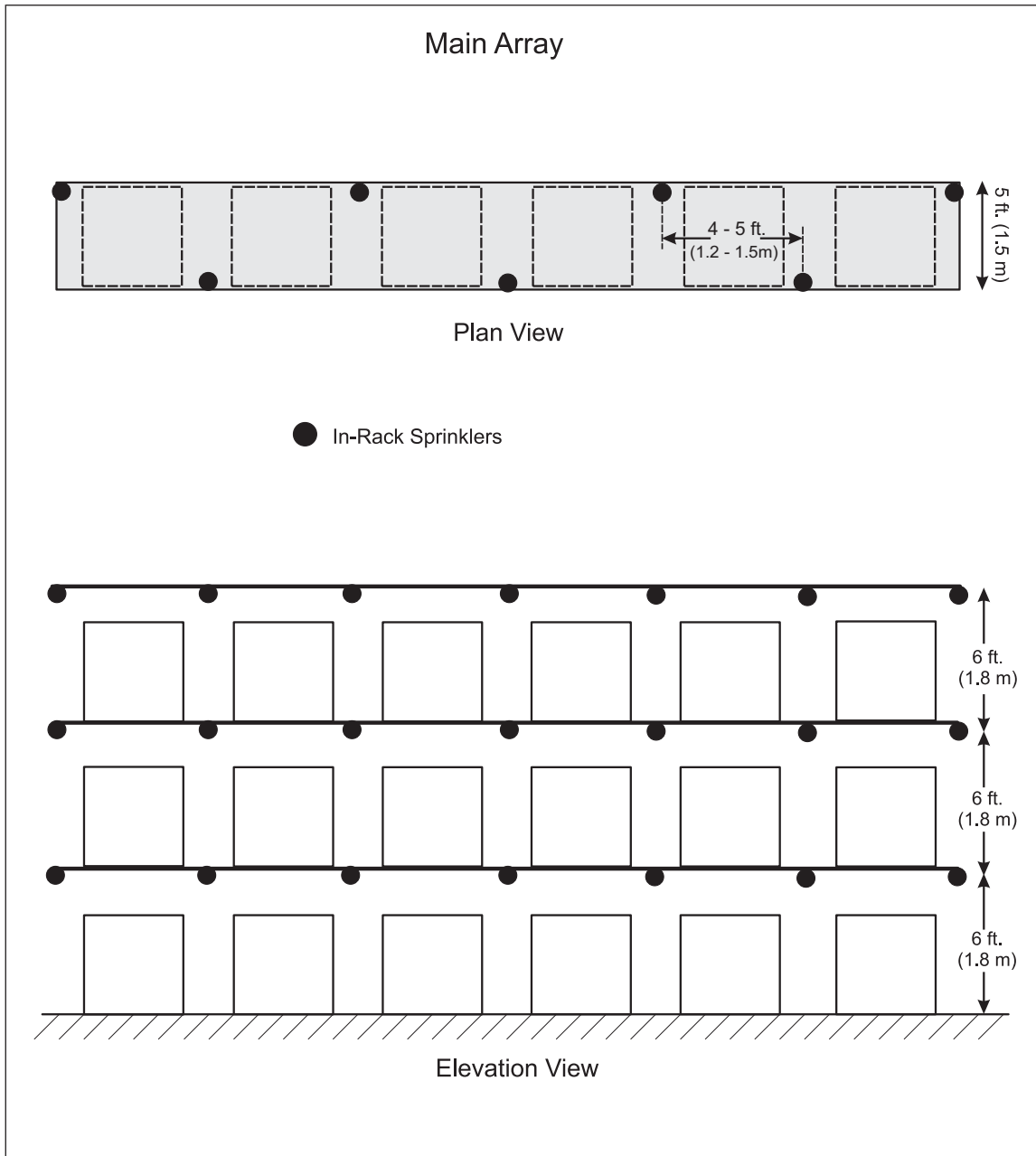

Fig. D.2.2.4.2. Single-row rack sprinkler layout: fire protection scheme D

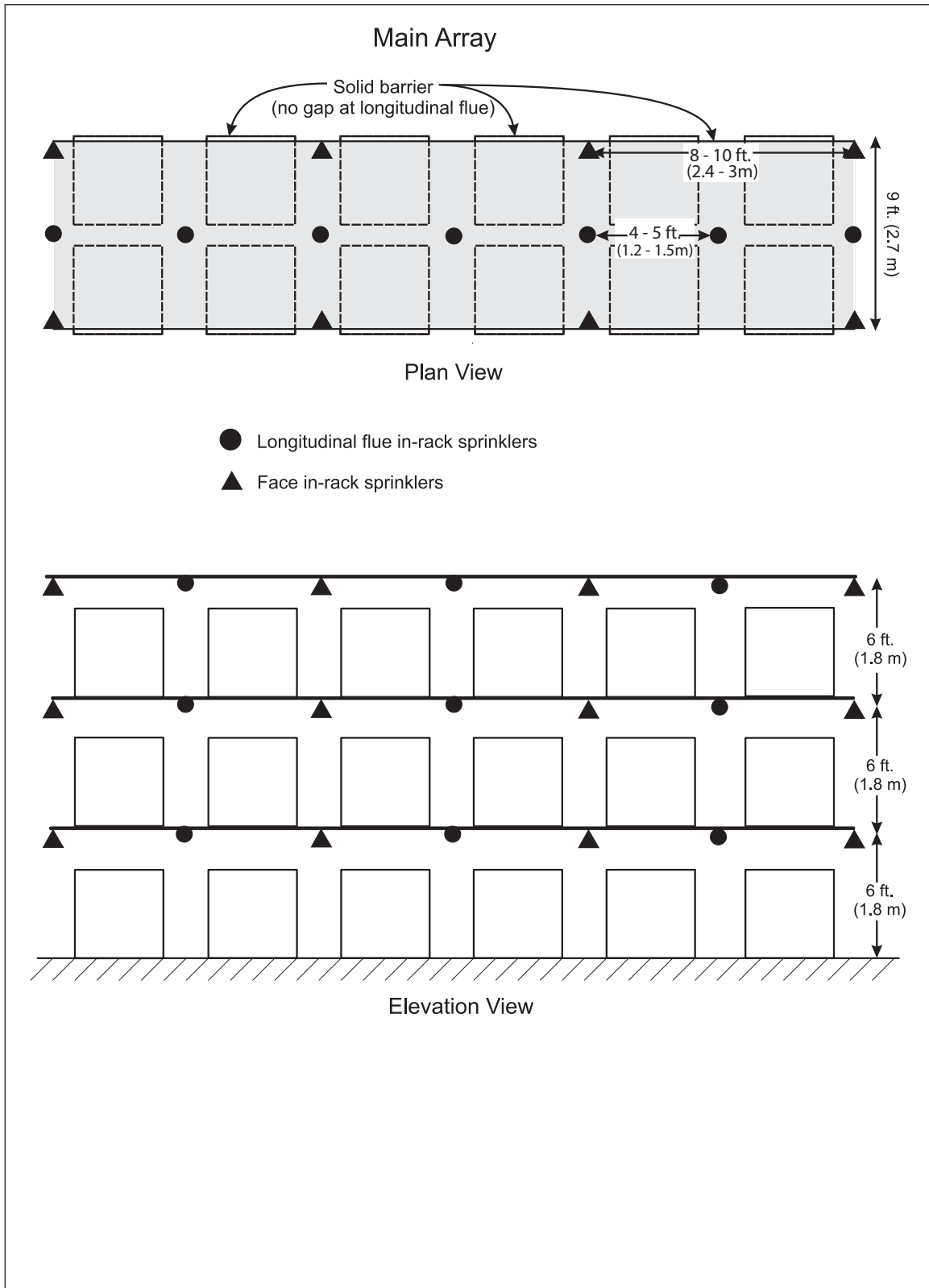

Fig. D.2.2.4.3. Double-row rack sprinkler layout: fire protection scheme D

D.2.2.5 Fire Protection Scheme E

D.2.2.5.1 Install in-rack sprinklers on 20 ft (6 m) vertical increments in accordance with Figures D.2.2.5.1 and D.2.2.5.2. Repeat the in-rack pattern shown in Figure D.2.2.5.2 from rack face to rack face for multiple row racks.

D.2.2.5.2 Install FM Approved K8.0 (115) or K11.2 (160), 165°F (74°C) rated, quick response, in-rack sprinklers.

D.2.2.5.3 Design the in-rack sprinklers to provide a minimum flow of 30 gpm (110 L/min) out of the hydraulically most remote:

1. Six in-rack sprinklers on 1 level if one level of in-racks (6 total).
2. Six in-rack sprinklers on 2 levels if two level of in-racks (12 total).
3. Six in-rack sprinklers on 3 levels if three or more levels of in-racks (18 total).

D.2.2.5.4 If there are adjacent bays of rack storage not dedicated to liquid storage, extend the in-rack sprinkler protection by at least one rack bay, approximately 8 ft (2.4 m) beyond the liquid storage.

D.2.2.5.5 Balance the ceiling and in-rack demands at the point of connection to the water supply. Provide a 500 gpm (1890 L/min) hose stream allowance in the hydraulic calculations. Provide the combined fire protection water demand for a 1-hour duration.

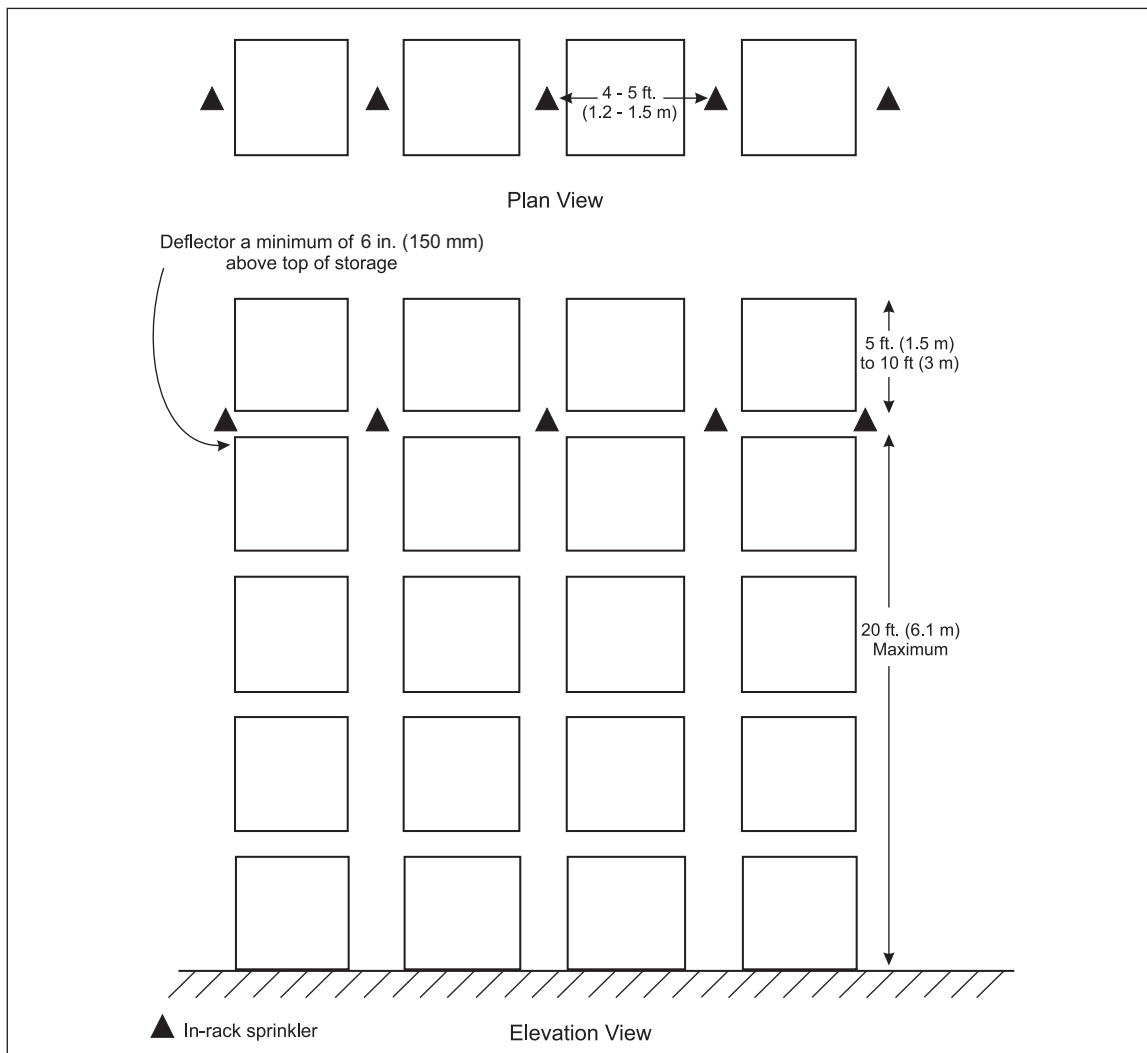

Fig. D.2.2.5.1. Single-row rack sprinkler layout: fire protection scheme E

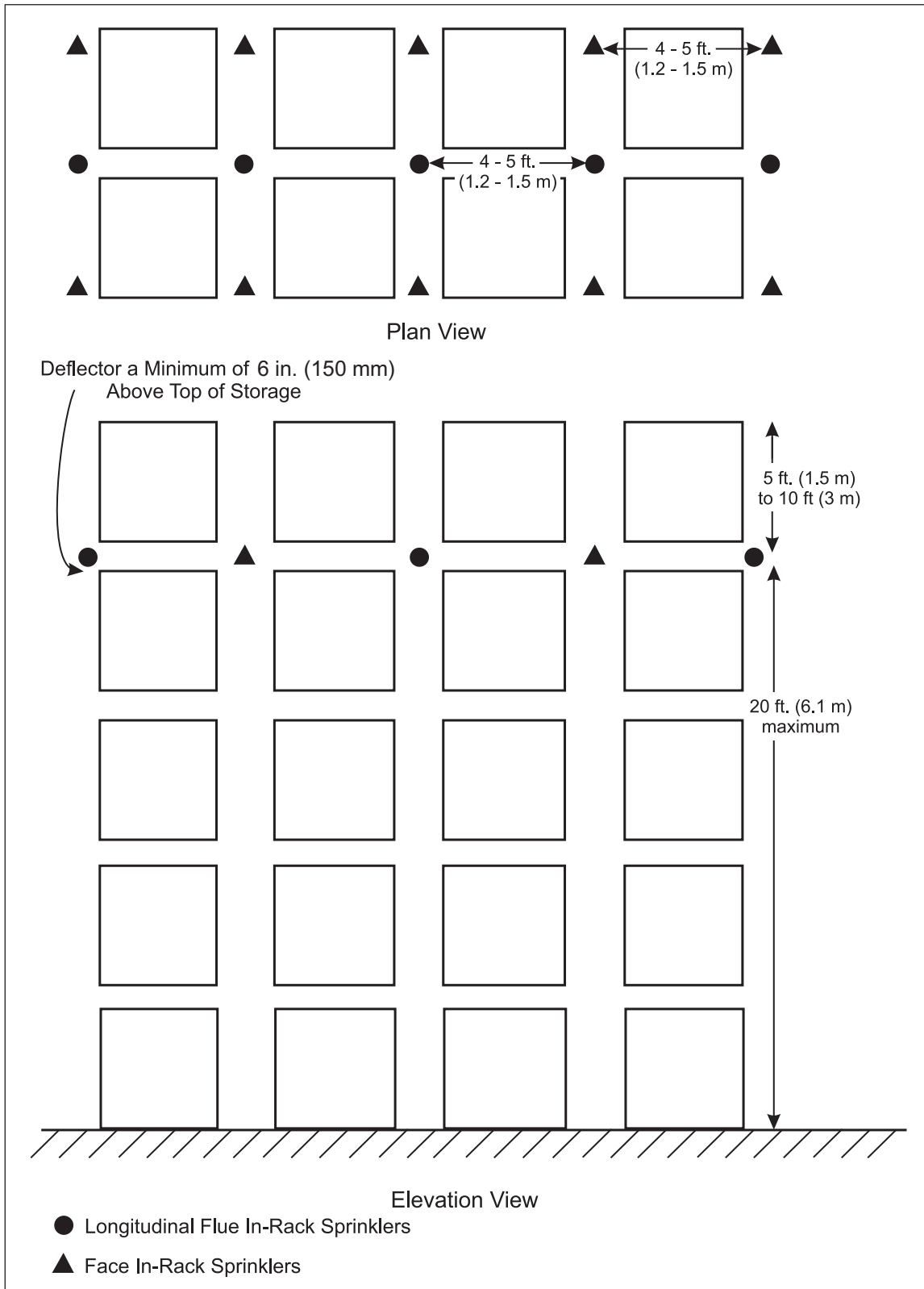

Fig. D.2.2.5.2. Double-row rack sprinkler layout: fire protection scheme E

APPENDIX E STEEL COLUMN PROTECTION

E.1 Protect steel columns where the liquid pool fire will affect all four sides of the column, located inside detached buildings or cutoff rooms, using one of the following methods or an equivalent:

A. Provide fireproofing rated for one hour or the expected fire duration, whichever is greater. Provide fireproofing that is rated for a hydrocarbon fire exposure. (See Data Sheet 1-21, *Fire Resistance of Building Assemblies*.)

B. Provide automatic (fusible link) sidewall sprinklers or water spray protection for the full height of the column, as shown in Figure E.1.B and described below:

- i. Stagger the nozzles on opposite sides of a wide-flange column on 20 ft (6.1 m) centers.
- ii. Wet the reentrant space (web and flanges)(shown by black outline in Figure E.1) to cool the column effectively.
- iii. Provide a minimum 0.3 gpm/ft² (12 mm/min) over the wetted area of the column ("wetted area" is the surface area on the three sides of the reentrant space formed by the column web and flanges). The wetted area protected by a sprinkler extends from the sprinkler down to the next sprinkler on the same side of the column.
- iv. Where obstructions to run down are present, provide additional sprinklers below the obstructions.

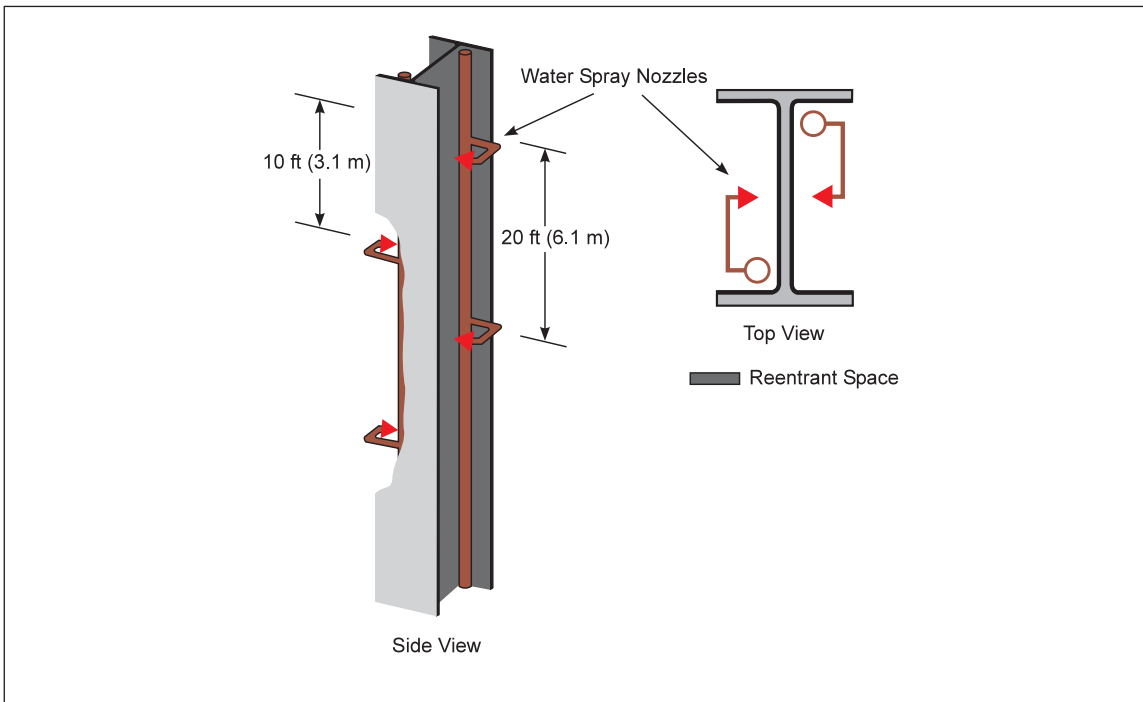

Fig. E.1.B. Water spray protection for steel columns

APPENDIX F CLASSIFICATION OF LIQUIDS THAT BURN

F.1 Ignitable Liquid Classification Schemes

Existing classification schemes for liquids that burn are based on their closed-cup flash points. Some assign numerical values, while others group liquids by name (e.g., flammable, combustible) according to flash point ranges. Some classifications have many subdivisions and others only define a couple. None of them, however, define the fire hazard created by the liquid, and, in many cases, there is confusion regarding the severity of the hazard.

Classifying liquids based on flash point started when liquids were commonly mixed in open vessels or tanks, and a measure of the potential for ignition was needed. The flash point served this purpose well, but it does

not provide any measure of the fire or explosion hazard created by a given liquid. The fire and explosion hazards of liquids that burn are actually determined by the inherent physical properties of the liquid and external factors such as the amount of liquid, process temperatures, process flow rates, and building construction.